

# Appendix AQ

---

California Emissions Estimator Model (CalEEMod) Output Files

Rezoning Sites for Housing Project - Sonoma County - Sonoma-San Francisco County, Winter

**Rezoning Sites for Housing Project - Sonoma County  
Sonoma-San Francisco County, Winter**

**1.0 Project Characteristics**

---

**1.1 Land Usage**

Land Uses	Size	Metric	Lot Acreage	Floor Surface Area	Population
Single Family Housing	38.00	Dwelling Unit	12.34	68,400.00	109

**1.2 Other Project Characteristics**

<b>Urbanization</b>	Urban	<b>Wind Speed (m/s)</b>	2.2	<b>Precipitation Freq (Days)</b>	75
<b>Climate Zone</b>	4			<b>Operational Year</b>	2021
<b>Utility Company</b>	Pacific Gas & Electric Company				
<b>CO2 Intensity (lb/MW hr)</b>	641.35	<b>CH4 Intensity (lb/MW hr)</b>	0.029	<b>N2O Intensity (lb/MW hr)</b>	0.006

**1.3 User Entered Comments & Non-Default Data**

Rezoning Sites for Housing Project - Sonoma County - Sonoma-San Francisco County, Winter

Project Characteristics -

Land Use -

Construction Phase - Grading portion extended to represent a realistic length for amount of soil import/export.

Trips and VMT -

Demolition -

Grading -

Architectural Coating -

Vehicle Trips - Adjusted trip rates for VMT total

Woodstoves - '

Area Coating -

Water And Wastewater -

Solid Waste -

Construction Off-road Equipment Mitigation -

Table Name	Column Name	Default Value	New Value
tblConstructionPhase	NumDays	30.00	60.00
tblGrading	MaterialExported	0.00	5,808.00
tblGrading	MaterialImported	0.00	5,808.00
tblVehicleTrips	ST_TR	9.91	3.50
tblVehicleTrips	SU_TR	8.62	3.50
tblVehicleTrips	WD_TR	9.52	3.50

**2.0 Emissions Summary**

---



Rezoning Sites for Housing Project - Sonoma County - Sonoma-San Francisco County, Winter

**2.2 Overall Operational**

**Unmitigated Operational**

	ROG	NOx	CO	SO2	Fugitive PM10	Exhaust PM10	PM10 Total	Fugitive PM2.5	Exhaust PM2.5	PM2.5 Total	Bio- CO2	NBio- CO2	Total CO2	CH4	N2O	CO2e
Category	lb/day										lb/day					
Area	41.2029	0.7945	54.0728	0.0961		7.2192	7.2192		7.2192	7.2192	774.3769	240.3509	1,014.7277	0.9630	0.0546	1,055.0852
Energy	0.0326	0.2789	0.1187	1.7800e-003		0.0226	0.0226		0.0226	0.0226		355.9947	355.9947	6.8200e-003	6.5300e-003	358.1102
Mobile	0.2439	1.2499	2.8601	7.8900e-003	0.6550	8.3800e-003	0.6633	0.1756	7.8800e-003	0.1835		798.5361	798.5361	0.0371		799.4643
<b>Total</b>	<b>41.4793</b>	<b>2.3233</b>	<b>57.0516</b>	<b>0.1058</b>	<b>0.6550</b>	<b>7.2501</b>	<b>7.9051</b>	<b>0.1756</b>	<b>7.2496</b>	<b>7.4252</b>	<b>774.3769</b>	<b>1,394.8816</b>	<b>2,169.2585</b>	<b>1.0069</b>	<b>0.0612</b>	<b>2,212.6596</b>

**Mitigated Operational**

	ROG	NOx	CO	SO2	Fugitive PM10	Exhaust PM10	PM10 Total	Fugitive PM2.5	Exhaust PM2.5	PM2.5 Total	Bio- CO2	NBio- CO2	Total CO2	CH4	N2O	CO2e
Category	lb/day										lb/day					
Area	41.2029	0.7945	54.0728	0.0961		7.2192	7.2192		7.2192	7.2192	774.3769	240.3509	1,014.7277	0.9630	0.0546	1,055.0852
Energy	0.0326	0.2789	0.1187	1.7800e-003		0.0226	0.0226		0.0226	0.0226		355.9947	355.9947	6.8200e-003	6.5300e-003	358.1102
Mobile	0.2439	1.2499	2.8601	7.8900e-003	0.6550	8.3800e-003	0.6633	0.1756	7.8800e-003	0.1835		798.5361	798.5361	0.0371		799.4643
<b>Total</b>	<b>41.4793</b>	<b>2.3233</b>	<b>57.0516</b>	<b>0.1058</b>	<b>0.6550</b>	<b>7.2501</b>	<b>7.9051</b>	<b>0.1756</b>	<b>7.2496</b>	<b>7.4252</b>	<b>774.3769</b>	<b>1,394.8816</b>	<b>2,169.2585</b>	<b>1.0069</b>	<b>0.0612</b>	<b>2,212.6596</b>

## Rezoning Sites for Housing Project - Sonoma County - Sonoma-San Francisco County, Winter

	ROG	NOx	CO	SO2	Fugitive PM10	Exhaust PM10	PM10 Total	Fugitive PM2.5	Exhaust PM2.5	PM2.5 Total	Bio- CO2	NBio-CO2	Total CO2	CH4	N2O	CO2e
Percent Reduction	0.00	0.00	0.00	0.00	0.00	0.00	0.00	0.00	0.00	0.00	0.00	0.00	0.00	0.00	0.00	0.00

### 3.0 Construction Detail

---

#### Construction Phase

Phase Number	Phase Name	Phase Type	Start Date	End Date	Num Days Week	Num Days	Phase Description
1	Demolition	Demolition	1/1/2021	1/28/2021	5	20	
2	Site Preparation	Site Preparation	1/29/2021	2/11/2021	5	10	
3	Grading	Grading	2/12/2021	5/6/2021	5	60	
4	Building Construction	Building Construction	5/7/2021	6/30/2022	5	300	
5	Paving	Paving	7/1/2022	7/28/2022	5	20	
6	Architectural Coating	Architectural Coating	7/29/2022	8/25/2022	5	20	

**Acres of Grading (Site Preparation Phase): 0**

**Acres of Grading (Grading Phase): 150**

**Acres of Paving: 0**

**Residential Indoor: 138,510; Residential Outdoor: 46,170; Non-Residential Indoor: 0; Non-Residential Outdoor: 0; Striped Parking Area: 0 (Architectural Coating – sqft)**

#### OffRoad Equipment











Rezoning Sites for Housing Project - Sonoma County - Sonoma-San Francisco County, Winter

**3.3 Site Preparation - 2021**

**Unmitigated Construction Off-Site**

	ROG	NOx	CO	SO2	Fugitive PM10	Exhaust PM10	PM10 Total	Fugitive PM2.5	Exhaust PM2.5	PM2.5 Total	Bio- CO2	NBio- CO2	Total CO2	CH4	N2O	CO2e
Category	lb/day										lb/day					
Hauling	0.0000	0.0000	0.0000	0.0000	0.0000	0.0000	0.0000	0.0000	0.0000	0.0000		0.0000	0.0000	0.0000		0.0000
Vendor	0.0000	0.0000	0.0000	0.0000	0.0000	0.0000	0.0000	0.0000	0.0000	0.0000		0.0000	0.0000	0.0000		0.0000
Worker	0.0880	0.0615	0.5838	1.3800e-003	0.1479	1.1000e-003	0.1490	0.0392	1.0200e-003	0.0402		136.9553	136.9553	4.7100e-003		137.0730
<b>Total</b>	<b>0.0880</b>	<b>0.0615</b>	<b>0.5838</b>	<b>1.3800e-003</b>	<b>0.1479</b>	<b>1.1000e-003</b>	<b>0.1490</b>	<b>0.0392</b>	<b>1.0200e-003</b>	<b>0.0402</b>		<b>136.9553</b>	<b>136.9553</b>	<b>4.7100e-003</b>		<b>137.0730</b>

**Mitigated Construction On-Site**

	ROG	NOx	CO	SO2	Fugitive PM10	Exhaust PM10	PM10 Total	Fugitive PM2.5	Exhaust PM2.5	PM2.5 Total	Bio- CO2	NBio- CO2	Total CO2	CH4	N2O	CO2e
Category	lb/day										lb/day					
Fugitive Dust					18.0663	0.0000	18.0663	9.9307	0.0000	9.9307			0.0000			0.0000
Off-Road	3.8882	40.4971	21.1543	0.0380		2.0445	2.0445		1.8809	1.8809	0.0000	3,685.6569	3,685.6569	1.1920		3,715.4573
<b>Total</b>	<b>3.8882</b>	<b>40.4971</b>	<b>21.1543</b>	<b>0.0380</b>	<b>18.0663</b>	<b>2.0445</b>	<b>20.1107</b>	<b>9.9307</b>	<b>1.8809</b>	<b>11.8116</b>	<b>0.0000</b>	<b>3,685.6569</b>	<b>3,685.6569</b>	<b>1.1920</b>		<b>3,715.4573</b>

Rezoning Sites for Housing Project - Sonoma County - Sonoma-San Francisco County, Winter

**3.3 Site Preparation - 2021**

**Mitigated Construction Off-Site**

	ROG	NOx	CO	SO2	Fugitive PM10	Exhaust PM10	PM10 Total	Fugitive PM2.5	Exhaust PM2.5	PM2.5 Total	Bio- CO2	NBio- CO2	Total CO2	CH4	N2O	CO2e
Category	lb/day										lb/day					
Hauling	0.0000	0.0000	0.0000	0.0000	0.0000	0.0000	0.0000	0.0000	0.0000	0.0000		0.0000	0.0000	0.0000		0.0000
Vendor	0.0000	0.0000	0.0000	0.0000	0.0000	0.0000	0.0000	0.0000	0.0000	0.0000		0.0000	0.0000	0.0000		0.0000
Worker	0.0880	0.0615	0.5838	1.3800e-003	0.1479	1.1000e-003	0.1490	0.0392	1.0200e-003	0.0402		136.9553	136.9553	4.7100e-003		137.0730
<b>Total</b>	<b>0.0880</b>	<b>0.0615</b>	<b>0.5838</b>	<b>1.3800e-003</b>	<b>0.1479</b>	<b>1.1000e-003</b>	<b>0.1490</b>	<b>0.0392</b>	<b>1.0200e-003</b>	<b>0.0402</b>		<b>136.9553</b>	<b>136.9553</b>	<b>4.7100e-003</b>		<b>137.0730</b>

**3.4 Grading - 2021**

**Unmitigated Construction On-Site**

	ROG	NOx	CO	SO2	Fugitive PM10	Exhaust PM10	PM10 Total	Fugitive PM2.5	Exhaust PM2.5	PM2.5 Total	Bio- CO2	NBio- CO2	Total CO2	CH4	N2O	CO2e
Category	lb/day										lb/day					
Fugitive Dust					8.6952	0.0000	8.6952	3.5998	0.0000	3.5998			0.0000			0.0000
Off-Road	4.1912	46.3998	30.8785	0.0620		1.9853	1.9853		1.8265	1.8265		6,007.0434	6,007.0434	1.9428		6,055.6134
<b>Total</b>	<b>4.1912</b>	<b>46.3998</b>	<b>30.8785</b>	<b>0.0620</b>	<b>8.6952</b>	<b>1.9853</b>	<b>10.6806</b>	<b>3.5998</b>	<b>1.8265</b>	<b>5.4263</b>		<b>6,007.0434</b>	<b>6,007.0434</b>	<b>1.9428</b>		<b>6,055.6134</b>

Rezoning Sites for Housing Project - Sonoma County - Sonoma-San Francisco County, Winter

**3.4 Grading - 2021**

**Unmitigated Construction Off-Site**

	ROG	NOx	CO	SO2	Fugitive PM10	Exhaust PM10	PM10 Total	Fugitive PM2.5	Exhaust PM2.5	PM2.5 Total	Bio- CO2	NBio- CO2	Total CO2	CH4	N2O	CO2e
Category	lb/day										lb/day					
Hauling	0.1843	6.6164	1.4534	0.0187	0.4177	0.0228	0.4405	0.1140	0.0218	0.1358		2,011.7262	2,011.7262	0.1280		2,014.9271
Vendor	0.0000	0.0000	0.0000	0.0000	0.0000	0.0000	0.0000	0.0000	0.0000	0.0000		0.0000	0.0000	0.0000		0.0000
Worker	0.0978	0.0683	0.6487	1.5300e-003	0.1643	1.2300e-003	0.1655	0.0436	1.1300e-003	0.0447		152.1726	152.1726	5.2300e-003		152.3033
<b>Total</b>	<b>0.2821</b>	<b>6.6847</b>	<b>2.1021</b>	<b>0.0202</b>	<b>0.5820</b>	<b>0.0240</b>	<b>0.6060</b>	<b>0.1576</b>	<b>0.0229</b>	<b>0.1805</b>		<b>2,163.8988</b>	<b>2,163.8988</b>	<b>0.1333</b>		<b>2,167.2305</b>

**Mitigated Construction On-Site**

	ROG	NOx	CO	SO2	Fugitive PM10	Exhaust PM10	PM10 Total	Fugitive PM2.5	Exhaust PM2.5	PM2.5 Total	Bio- CO2	NBio- CO2	Total CO2	CH4	N2O	CO2e
Category	lb/day										lb/day					
Fugitive Dust					8.6952	0.0000	8.6952	3.5998	0.0000	3.5998			0.0000			0.0000
Off-Road	4.1912	46.3998	30.8785	0.0620		1.9853	1.9853		1.8265	1.8265	0.0000	6,007.0434	6,007.0434	1.9428		6,055.6134
<b>Total</b>	<b>4.1912</b>	<b>46.3998</b>	<b>30.8785</b>	<b>0.0620</b>	<b>8.6952</b>	<b>1.9853</b>	<b>10.6806</b>	<b>3.5998</b>	<b>1.8265</b>	<b>5.4263</b>	<b>0.0000</b>	<b>6,007.0434</b>	<b>6,007.0434</b>	<b>1.9428</b>		<b>6,055.6134</b>

Rezoning Sites for Housing Project - Sonoma County - Sonoma-San Francisco County, Winter

**3.4 Grading - 2021**

**Mitigated Construction Off-Site**

	ROG	NOx	CO	SO2	Fugitive PM10	Exhaust PM10	PM10 Total	Fugitive PM2.5	Exhaust PM2.5	PM2.5 Total	Bio- CO2	NBio- CO2	Total CO2	CH4	N2O	CO2e
Category	lb/day										lb/day					
Hauling	0.1843	6.6164	1.4534	0.0187	0.4177	0.0228	0.4405	0.1140	0.0218	0.1358		2,011.7262	2,011.7262	0.1280		2,014.9271
Vendor	0.0000	0.0000	0.0000	0.0000	0.0000	0.0000	0.0000	0.0000	0.0000	0.0000		0.0000	0.0000	0.0000		0.0000
Worker	0.0978	0.0683	0.6487	1.5300e-003	0.1643	1.2300e-003	0.1655	0.0436	1.1300e-003	0.0447		152.1726	152.1726	5.2300e-003		152.3033
<b>Total</b>	<b>0.2821</b>	<b>6.6847</b>	<b>2.1021</b>	<b>0.0202</b>	<b>0.5820</b>	<b>0.0240</b>	<b>0.6060</b>	<b>0.1576</b>	<b>0.0229</b>	<b>0.1805</b>		<b>2,163.8988</b>	<b>2,163.8988</b>	<b>0.1333</b>		<b>2,167.2305</b>

**3.5 Building Construction - 2021**

**Unmitigated Construction On-Site**

	ROG	NOx	CO	SO2	Fugitive PM10	Exhaust PM10	PM10 Total	Fugitive PM2.5	Exhaust PM2.5	PM2.5 Total	Bio- CO2	NBio- CO2	Total CO2	CH4	N2O	CO2e
Category	lb/day										lb/day					
Off-Road	1.9009	17.4321	16.5752	0.0269		0.9586	0.9586		0.9013	0.9013		2,553.3639	2,553.3639	0.6160		2,568.7643
<b>Total</b>	<b>1.9009</b>	<b>17.4321</b>	<b>16.5752</b>	<b>0.0269</b>		<b>0.9586</b>	<b>0.9586</b>		<b>0.9013</b>	<b>0.9013</b>		<b>2,553.3639</b>	<b>2,553.3639</b>	<b>0.6160</b>		<b>2,568.7643</b>

Rezoning Sites for Housing Project - Sonoma County - Sonoma-San Francisco County, Winter

**3.5 Building Construction - 2021**

**Unmitigated Construction Off-Site**

	ROG	NOx	CO	SO2	Fugitive PM10	Exhaust PM10	PM10 Total	Fugitive PM2.5	Exhaust PM2.5	PM2.5 Total	Bio- CO2	NBio- CO2	Total CO2	CH4	N2O	CO2e
Category	lb/day										lb/day					
Hauling	0.0000	0.0000	0.0000	0.0000	0.0000	0.0000	0.0000	0.0000	0.0000	0.0000		0.0000	0.0000	0.0000		0.0000
Vendor	0.0132	0.4355	0.1144	1.0400e-003	0.0269	1.1200e-003	0.0280	7.7400e-003	1.0700e-003	8.8100e-003		111.0783	111.0783	6.9700e-003		111.2526
Worker	0.0684	0.0478	0.4541	1.0700e-003	0.1150	8.6000e-004	0.1159	0.0305	7.9000e-004	0.0313		106.5208	106.5208	3.6600e-003		106.6123
<b>Total</b>	<b>0.0816</b>	<b>0.4833</b>	<b>0.5685</b>	<b>2.1100e-003</b>	<b>0.1419</b>	<b>1.9800e-003</b>	<b>0.1439</b>	<b>0.0383</b>	<b>1.8600e-003</b>	<b>0.0401</b>		<b>217.5991</b>	<b>217.5991</b>	<b>0.0106</b>		<b>217.8649</b>

**Mitigated Construction On-Site**

	ROG	NOx	CO	SO2	Fugitive PM10	Exhaust PM10	PM10 Total	Fugitive PM2.5	Exhaust PM2.5	PM2.5 Total	Bio- CO2	NBio- CO2	Total CO2	CH4	N2O	CO2e
Category	lb/day										lb/day					
Off-Road	1.9009	17.4321	16.5752	0.0269		0.9586	0.9586		0.9013	0.9013	0.0000	2,553.3639	2,553.3639	0.6160		2,568.7643
<b>Total</b>	<b>1.9009</b>	<b>17.4321</b>	<b>16.5752</b>	<b>0.0269</b>		<b>0.9586</b>	<b>0.9586</b>		<b>0.9013</b>	<b>0.9013</b>	<b>0.0000</b>	<b>2,553.3639</b>	<b>2,553.3639</b>	<b>0.6160</b>		<b>2,568.7643</b>

















Rezoning Sites for Housing Project - Sonoma County - Sonoma-San Francisco County, Winter

	ROG	NOx	CO	SO2	Fugitive PM10	Exhaust PM10	PM10 Total	Fugitive PM2.5	Exhaust PM2.5	PM2.5 Total	Bio- CO2	NBio- CO2	Total CO2	CH4	N2O	CO2e
Category	lb/day										lb/day					
Mitigated	0.2439	1.2499	2.8601	7.8900e-003	0.6550	8.3800e-003	0.6633	0.1756	7.8800e-003	0.1835		798.5361	798.5361	0.0371		799.4643
Unmitigated	0.2439	1.2499	2.8601	7.8900e-003	0.6550	8.3800e-003	0.6633	0.1756	7.8800e-003	0.1835		798.5361	798.5361	0.0371		799.4643

4.2 Trip Summary Information

Land Use	Average Daily Trip Rate			Unmitigated	Mitigated
	Weekday	Saturday	Sunday	Annual VMT	Annual VMT
Single Family Housing	133.00	133.00	133.00	307,178	307,178
Total	133.00	133.00	133.00	307,178	307,178

4.3 Trip Type Information

Land Use	Miles			Trip %			Trip Purpose %		
	H-W or C-W	H-S or C-C	H-O or C-NW	H-W or C-W	H-S or C-C	H-O or C-NW	Primary	Diverted	Pass-by
Single Family Housing	10.80	4.80	5.70	31.00	15.00	54.00	86	11	3

4.4 Fleet Mix

Land Use	LDA	LDT1	LDT2	MDV	LHD1	LHD2	MHD	HHD	OBUS	UBUS	MCY	SBUS	MH
Single Family Housing	0.578299	0.039453	0.169996	0.109068	0.028307	0.006716	0.029274	0.026666	0.003071	0.001838	0.005325	0.000874	0.001112

5.0 Energy Detail

Historical Energy Use: N

Rezoning Sites for Housing Project - Sonoma County - Sonoma-San Francisco County, Winter

**5.1 Mitigation Measures Energy**

	ROG	NOx	CO	SO2	Fugitive PM10	Exhaust PM10	PM10 Total	Fugitive PM2.5	Exhaust PM2.5	PM2.5 Total	Bio- CO2	NBio- CO2	Total CO2	CH4	N2O	CO2e
Category	lb/day										lb/day					
NaturalGas Mitigated	0.0326	0.2789	0.1187	1.7800e-003		0.0226	0.0226		0.0226	0.0226		355.9947	355.9947	6.8200e-003	6.5300e-003	358.1102
NaturalGas Unmitigated	0.0326	0.2789	0.1187	1.7800e-003		0.0226	0.0226		0.0226	0.0226		355.9947	355.9947	6.8200e-003	6.5300e-003	358.1102

**5.2 Energy by Land Use - NaturalGas**

**Unmitigated**

	NaturalGas Use	ROG	NOx	CO	SO2	Fugitive PM10	Exhaust PM10	PM10 Total	Fugitive PM2.5	Exhaust PM2.5	PM2.5 Total	Bio- CO2	NBio- CO2	Total CO2	CH4	N2O	CO2e
Land Use	kBTU/yr	lb/day										lb/day					
Single Family Housing	3025.95	0.0326	0.2789	0.1187	1.7800e-003		0.0226	0.0226		0.0226	0.0226		355.9947	355.9947	6.8200e-003	6.5300e-003	358.1102
<b>Total</b>		<b>0.0326</b>	<b>0.2789</b>	<b>0.1187</b>	<b>1.7800e-003</b>		<b>0.0226</b>	<b>0.0226</b>		<b>0.0226</b>	<b>0.0226</b>		<b>355.9947</b>	<b>355.9947</b>	<b>6.8200e-003</b>	<b>6.5300e-003</b>	<b>358.1102</b>



Rezoning Sites for Housing Project - Sonoma County - Sonoma-San Francisco County, Winter

**5.2 Energy by Land Use - Natural Gas**

**Mitigated**

	Natural Gas Use	ROG	NOx	CO	SO2	Fugitive PM10	Exhaust PM10	PM10 Total	Fugitive PM2.5	Exhaust PM2.5	PM2.5 Total	Bio- CO2	NBio- CO2	Total CO2	CH4	N2O	CO2e
Land Use	kBTU/yr	lb/day										lb/day					
Single Family Housing	3.02595	0.0326	0.2789	0.1187	1.7800e-003		0.0226	0.0226		0.0226	0.0226		355.9947	355.9947	6.8200e-003	6.5300e-003	358.1102
<b>Total</b>		<b>0.0326</b>	<b>0.2789</b>	<b>0.1187</b>	<b>1.7800e-003</b>		<b>0.0226</b>	<b>0.0226</b>		<b>0.0226</b>	<b>0.0226</b>		<b>355.9947</b>	<b>355.9947</b>	<b>6.8200e-003</b>	<b>6.5300e-003</b>	<b>358.1102</b>

**6.0 Area Detail**

**6.1 Mitigation Measures Area**

	ROG	NOx	CO	SO2	Fugitive PM10	Exhaust PM10	PM10 Total	Fugitive PM2.5	Exhaust PM2.5	PM2.5 Total	Bio- CO2	NBio- CO2	Total CO2	CH4	N2O	CO2e
Category	lb/day										lb/day					
Mitigated	41.2029	0.7945	54.0728	0.0961		7.2192	7.2192		7.2192	7.2192	774.3769	240.3509	1,014.7277	0.9630	0.0546	1,055.0852
Unmitigated	41.2029	0.7945	54.0728	0.0961		7.2192	7.2192		7.2192	7.2192	774.3769	240.3509	1,014.7277	0.9630	0.0546	1,055.0852

Rezoning Sites for Housing Project - Sonoma County - Sonoma-San Francisco County, Winter

**6.2 Area by SubCategory**

**Unmitigated**

	ROG	NOx	CO	SO2	Fugitive PM10	Exhaust PM10	PM10 Total	Fugitive PM2.5	Exhaust PM2.5	PM2.5 Total	Bio- CO2	NBio- CO2	Total CO2	CH4	N2O	CO2e
SubCategory	lb/day										lb/day					
Architectural Coating	0.2638					0.0000	0.0000		0.0000	0.0000			0.0000			0.0000
Consumer Products	1.4638					0.0000	0.0000		0.0000	0.0000			0.0000			0.0000
Hearth	39.3801	0.7583	50.9310	0.0959		7.2019	7.2019		7.2019	7.2019	774.3769	234.7059	1,009.0828	0.9575	0.0546	1,049.3034
Landscaping	0.0952	0.0363	3.1419	1.7000e-004		0.0173	0.0173		0.0173	0.0173		5.6450	5.6450	5.4700e-003		5.7818
<b>Total</b>	<b>41.2028</b>	<b>0.7945</b>	<b>54.0728</b>	<b>0.0961</b>		<b>7.2192</b>	<b>7.2192</b>		<b>7.2192</b>	<b>7.2192</b>	<b>774.3769</b>	<b>240.3509</b>	<b>1,014.7277</b>	<b>0.9630</b>	<b>0.0546</b>	<b>1,055.0852</b>

Rezoning Sites for Housing Project - Sonoma County - Sonoma-San Francisco County, Winter

**6.2 Area by SubCategory**

**Mitigated**

	ROG	NOx	CO	SO2	Fugitive PM10	Exhaust PM10	PM10 Total	Fugitive PM2.5	Exhaust PM2.5	PM2.5 Total	Bio- CO2	NBio- CO2	Total CO2	CH4	N2O	CO2e
SubCategory	lb/day										lb/day					
Architectural Coating	0.2638					0.0000	0.0000		0.0000	0.0000			0.0000			0.0000
Consumer Products	1.4638					0.0000	0.0000		0.0000	0.0000			0.0000			0.0000
Hearth	39.3801	0.7583	50.9310	0.0959		7.2019	7.2019		7.2019	7.2019	774.3769	234.7059	1,009.0828	0.9575	0.0546	1,049.3034
Landscaping	0.0952	0.0363	3.1419	1.7000e-004		0.0173	0.0173		0.0173	0.0173		5.6450	5.6450	5.4700e-003		5.7818
<b>Total</b>	<b>41.2028</b>	<b>0.7945</b>	<b>54.0728</b>	<b>0.0961</b>		<b>7.2192</b>	<b>7.2192</b>		<b>7.2192</b>	<b>7.2192</b>	<b>774.3769</b>	<b>240.3509</b>	<b>1,014.7277</b>	<b>0.9630</b>	<b>0.0546</b>	<b>1,055.0852</b>

**7.0 Water Detail**

**7.1 Mitigation Measures Water**

**8.0 Waste Detail**

**8.1 Mitigation Measures Waste**

**9.0 Operational Offroad**

Equipment Type	Number	Hours/Day	Days/Year	Horse Power	Load Factor	Fuel Type
----------------	--------	-----------	-----------	-------------	-------------	-----------

**10.0 Stationary Equipment**

Rezoning Sites for Housing Project - Sonoma County - Sonoma-San Francisco County, Winter

**6.2 Area by SubCategory**

**Mitigated**

	ROG	NOx	CO	SO2	Fugitive PM10	Exhaust PM10	PM10 Total	Fugitive PM2.5	Exhaust PM2.5	PM2.5 Total	Bio- CO2	NBio- CO2	Total CO2	CH4	N2O	CO2e
SubCategory	lb/day										lb/day					
Architectural Coating	0.2638					0.0000	0.0000		0.0000	0.0000			0.0000			0.0000
Consumer Products	1.4638					0.0000	0.0000		0.0000	0.0000			0.0000			0.0000
Hearth	39.3801	0.7583	50.9310	0.0959		7.2019	7.2019		7.2019	7.2019	774.3769	234.7059	1,009.0828	0.9575	0.0546	1,049.3034
Landscaping	0.0952	0.0363	3.1419	1.7000e-004		0.0173	0.0173		0.0173	0.0173		5.6450	5.6450	5.4700e-003		5.7818
<b>Total</b>	<b>41.2028</b>	<b>0.7945</b>	<b>54.0728</b>	<b>0.0961</b>		<b>7.2192</b>	<b>7.2192</b>		<b>7.2192</b>	<b>7.2192</b>	<b>774.3769</b>	<b>240.3509</b>	<b>1,014.7277</b>	<b>0.9630</b>	<b>0.0546</b>	<b>1,055.0852</b>

**7.0 Water Detail**

**7.1 Mitigation Measures Water**

**8.0 Waste Detail**

**8.1 Mitigation Measures Waste**

**9.0 Operational Offroad**

Equipment Type	Number	Hours/Day	Days/Year	Horse Power	Load Factor	Fuel Type
----------------	--------	-----------	-----------	-------------	-------------	-----------

**10.0 Stationary Equipment**

Rezoning Sites for Housing Project - Sonoma County - Sonoma-San Francisco County, Winter

**Fire Pumps and Emergency Generators**

Equipment Type	Number	Hours/Day	Hours/Year	Horse Power	Load Factor	Fuel Type
----------------	--------	-----------	------------	-------------	-------------	-----------

**Boilers**

Equipment Type	Number	Heat Input/Day	Heat Input/Year	Boiler Rating	Fuel Type
----------------	--------	----------------	-----------------	---------------	-----------

**User Defined Equipment**

Equipment Type	Number
----------------	--------

**11.0 Vegetation**

---

Rezoning Sites for Housing Project - Sonoma County - GHG Analysis - Sonoma-San Francisco County, Annual

**Rezoning Sites for Housing Project - Sonoma County - GHG Analysis**  
**Sonoma-San Francisco County, Annual**

**1.0 Project Characteristics**

---

**1.1 Land Usage**

Land Uses	Size	Metric	Lot Acreage	Floor Surface Area	Population
Single Family Housing	2,975.00	Dwelling Unit	965.91	5,355,000.00	8509

**1.2 Other Project Characteristics**

<b>Urbanization</b>	Urban	<b>Wind Speed (m/s)</b>	2.2	<b>Precipitation Freq (Days)</b>	75
<b>Climate Zone</b>	4			<b>Operational Year</b>	2021
<b>Utility Company</b>	Pacific Gas & Electric Company				
<b>CO2 Intensity (lb/MW hr)</b>	477.6	<b>CH4 Intensity (lb/MW hr)</b>	0.022	<b>N2O Intensity (lb/MW hr)</b>	0.005

**1.3 User Entered Comments & Non-Default Data**

Rezoning Sites for Housing Project - Sonoma County - GHG Analysis - Sonoma-San Francisco County, Annual

Project Characteristics - 2021 PG&E Intensity Factors

Land Use - 2,975 is total buildout increase over existing zoning; conservatively assumed SF as SF requires more energy than MF

Construction Phase - Schedule adjusted to fit a 10-year timescale.

Trips and VMT - '

Demolition - Assumed 5000 sf per day of demolition

Grading - Assumed 24 trips per day during grading

Architectural Coating -

Vehicle Trips - Adjusted trip rates for VMT total

Woodstoves -

Area Coating -

Energy Use -

Water And Wastewater -

Solid Waste -

Construction Off-road Equipment Mitigation - Per BAAQMD rules.

Energy Mitigation -

Water Mitigation -

## Rezoning Sites for Housing Project - Sonoma County - GHG Analysis - Sonoma-San Francisco County, Annual

Table Name	Column Name	Default Value	New Value
tblConstDustMitigation	WaterUnpavedRoadVehicleSpeed	0	15
tblConstructionPhase	NumDays	1,000.00	150.00
tblConstructionPhase	NumDays	600.00	150.00
tblConstructionPhase	NumDays	1,550.00	450.00
tblConstructionPhase	NumDays	15,500.00	1,000.00
tblConstructionPhase	NumDays	1,100.00	300.00
tblConstructionPhase	NumDays	1,100.00	300.00
tblGrading	MaterialExported	0.00	43,200.00
tblGrading	MaterialImported	0.00	43,200.00
tblProjectCharacteristics	CH4IntensityFactor	0.029	0.022
tblProjectCharacteristics	CO2IntensityFactor	641.35	477.6
tblProjectCharacteristics	N2OIntensityFactor	0.006	0.005
tblVehicleTrips	ST_TR	9.91	4.98
tblVehicleTrips	SU_TR	8.62	4.98
tblVehicleTrips	WD_TR	9.52	4.98

## 2.0 Emissions Summary

---



Rezoning Sites for Housing Project - Sonoma County - GHG Analysis - Sonoma-San Francisco County, Annual

**2.1 Overall Construction**

**Unmitigated Construction**

	ROG	NOx	CO	SO2	Fugitive PM10	Exhaust PM10	PM10 Total	Fugitive PM2.5	Exhaust PM2.5	PM2.5 Total	Bio- CO2	NBio- CO2	Total CO2	CH4	N2O	CO2e
Year	tons/yr										MT/yr					
2021	0.4754	5.0758	2.9569	6.5100e-003	1.4168	0.2315	1.6483	0.6192	0.2141	0.8333	0.0000	585.0635	585.0635	0.1403	0.0000	588.5704
2022	0.4916	5.6047	3.8128	9.8200e-003	1.7177	0.2144	1.9320	0.6504	0.1973	0.8477	0.0000	883.9070	883.9070	0.2288	0.0000	889.6269
2023	0.5012	5.1043	4.1896	0.0122	1.5500	0.1765	1.7264	0.5135	0.1626	0.6762	0.0000	1,103.7303	1,103.7303	0.2322	0.0000	1,109.5343
2024	0.7761	5.4629	6.2077	0.0237	1.3711	0.0922	1.4632	0.3711	0.0866	0.4577	0.0000	2,197.1578	2,197.1578	0.1482	0.0000	2,200.8631
2025	0.7223	5.2388	5.8616	0.0232	1.3658	0.0803	1.4461	0.3697	0.0754	0.4451	0.0000	2,146.8910	2,146.8910	0.1442	0.0000	2,150.4964
2026	0.6901	5.1683	5.5994	0.0227	1.3658	0.0799	1.4456	0.3697	0.0750	0.4447	0.0000	2,109.1750	2,109.1750	0.1414	0.0000	2,112.7110
2027	0.5035	3.9435	4.3665	0.0168	0.9725	0.0721	1.0447	0.2632	0.0675	0.3307	0.0000	1,550.3333	1,550.3333	0.1232	0.0000	1,553.4120
2028	4.6438	0.9898	1.7571	2.9300e-003	0.0434	0.0481	0.0915	0.0116	0.0443	0.0558	0.0000	258.3658	258.3658	0.0734	0.0000	260.1995
2029	32.8862	0.1864	0.6652	1.9900e-003	0.2192	7.8900e-003	0.2271	0.0583	7.7900e-003	0.0661	0.0000	178.1073	178.1073	4.4500e-003	0.0000	178.2184
2030	0.3779	1.6700e-003	7.2800e-003	2.0000e-005	2.5200e-003	4.0000e-005	2.5600e-003	6.7000e-004	4.0000e-005	7.1000e-004	0.0000	2.0025	2.0025	4.0000e-005	0.0000	2.0036
<b>Maximum</b>	<b>32.8862</b>	<b>5.6047</b>	<b>6.2077</b>	<b>0.0237</b>	<b>1.7177</b>	<b>0.2315</b>	<b>1.9320</b>	<b>0.6504</b>	<b>0.2141</b>	<b>0.8477</b>	<b>0.0000</b>	<b>2,197.1578</b>	<b>2,197.1578</b>	<b>0.2322</b>	<b>0.0000</b>	<b>2,200.8631</b>



## Rezoning Sites for Housing Project - Sonoma County - GHG Analysis - Sonoma-San Francisco County, Annual

Quarter	Start Date	End Date	Maximum Unmitigated ROG + NOX (tons/quarter)	Maximum Mitigated ROG + NOX (tons/quarter)
1	1-1-2021	3-31-2021	1.3217	1.3217
2	4-1-2021	6-30-2021	1.3312	1.3312
3	7-1-2021	9-30-2021	1.4258	1.4258
4	10-1-2021	12-31-2021	1.4633	1.4633
5	1-1-2022	3-31-2022	1.3248	1.3248
6	4-1-2022	6-30-2022	1.5810	1.5810
7	7-1-2022	9-30-2022	1.5984	1.5984
8	10-1-2022	12-31-2022	1.6034	1.6034
9	1-1-2023	3-31-2023	1.3586	1.3586
10	4-1-2023	6-30-2023	1.3709	1.3709
11	7-1-2023	9-30-2023	1.3859	1.3859
12	10-1-2023	12-31-2023	1.5183	1.5183
13	1-1-2024	3-31-2024	1.5689	1.5689
14	4-1-2024	6-30-2024	1.5370	1.5370
15	7-1-2024	9-30-2024	1.5539	1.5539
16	10-1-2024	12-31-2024	1.5861	1.5861
17	1-1-2025	3-31-2025	1.4874	1.4874
18	4-1-2025	6-30-2025	1.4746	1.4746
19	7-1-2025	9-30-2025	1.4908	1.4908
20	10-1-2025	12-31-2025	1.5204	1.5204
21	1-1-2026	3-31-2026	1.4607	1.4607
22	4-1-2026	6-30-2026	1.4496	1.4496
23	7-1-2026	9-30-2026	1.4656	1.4656
24	10-1-2026	12-31-2026	1.4932	1.4932
25	1-1-2027	3-31-2027	1.4354	1.4354
26	4-1-2027	6-30-2027	1.4260	1.4260

## Rezoning Sites for Housing Project - Sonoma County - GHG Analysis - Sonoma-San Francisco County, Annual

27	7-1-2027	9-30-2027	1.2701	1.2701
28	10-1-2027	12-31-2027	0.3145	0.3145
29	1-1-2028	3-31-2028	0.3109	0.3109
30	4-1-2028	6-30-2028	0.3106	0.3106
31	7-1-2028	9-30-2028	0.3140	0.3140
32	10-1-2028	12-31-2028	4.8464	4.8464
33	1-1-2029	3-31-2029	8.1488	8.1488
34	4-1-2029	6-30-2029	8.2359	8.2359
35	7-1-2029	9-30-2029	8.3264	8.3264
36	10-1-2029	12-31-2029	8.3299	8.3299
37	1-1-2030	3-31-2030	0.2712	0.2712
		Highest	8.3299	8.3299

Rezoning Sites for Housing Project - Sonoma County - GHG Analysis - Sonoma-San Francisco County, Annual

**2.2 Overall Operational**

**Unmitigated Operational**

	ROG	NOx	CO	SO2	Fugitive PM10	Exhaust PM10	PM10 Total	Fugitive PM2.5	Exhaust PM2.5	PM2.5 Total	Bio- CO2	NBio- CO2	Total CO2	CH4	N2O	CO2e
Category	tons/yr										MT/yr					
Area	42.8889	0.6398	47.6349	0.0537		3.7989	3.7989		3.7989	3.7989	378.1552	128.9324	507.0876	0.7495	0.0216	532.2658
Energy	0.4663	3.9843	1.6955	0.0254		0.3221	0.3221		0.3221	0.3221	0.0000	9,828.5977	9,828.5977	0.3286	0.1392	9,878.2903
Mobile	4.9629	24.7554	55.1400	0.1614	12.6974	0.1687	12.8662	3.4172	0.1585	3.5757	0.0000	14,828.9345	14,828.9345	0.6650	0.0000	14,845.5600
Waste						0.0000	0.0000		0.0000	0.0000	725.4450	0.0000	725.4450	42.8726	0.0000	1,797.2594
Water						0.0000	0.0000		0.0000	0.0000	61.4943	319.8689	381.3632	6.3308	0.1525	585.0734
<b>Total</b>	<b>48.3180</b>	<b>29.3796</b>	<b>104.4704</b>	<b>0.2406</b>	<b>12.6974</b>	<b>4.2898</b>	<b>16.9872</b>	<b>3.4172</b>	<b>4.2795</b>	<b>7.6967</b>	<b>1,165.0946</b>	<b>25,106.3335</b>	<b>26,271.4280</b>	<b>50.9465</b>	<b>0.3133</b>	<b>27,638.4488</b>

Rezoning Sites for Housing Project - Sonoma County - GHG Analysis - Sonoma-San Francisco County, Annual

**2.2 Overall Operational**

**Mitigated Operational**

	ROG	NOx	CO	SO2	Fugitive PM10	Exhaust PM10	PM10 Total	Fugitive PM2.5	Exhaust PM2.5	PM2.5 Total	Bio- CO2	NBio- CO2	Total CO2	CH4	N2O	CO2e
Category	tons/yr										MT/yr					
Area	42.8889	0.6398	47.6349	0.0537		3.7989	3.7989		3.7989	3.7989	378.1552	128.9324	507.0876	0.7495	0.0216	532.2658
Energy	0.4663	3.9843	1.6955	0.0254		0.3221	0.3221		0.3221	0.3221	0.0000	8,215.5314	8,215.5314	0.2543	0.1223	8,258.3340
Mobile	4.9629	24.7554	55.1400	0.1614	12.6974	0.1687	12.8662	3.4172	0.1585	3.5757	0.0000	14,828.9345	14,828.9345	0.6650	0.0000	14,845.5600
Waste						0.0000	0.0000		0.0000	0.0000	725.4450	0.0000	725.4450	42.8726	0.0000	1,797.2594
Water						0.0000	0.0000		0.0000	0.0000	49.1955	274.4260	323.6215	5.0655	0.1222	486.6688
<b>Total</b>	<b>48.3180</b>	<b>29.3796</b>	<b>104.4704</b>	<b>0.2406</b>	<b>12.6974</b>	<b>4.2898</b>	<b>16.9872</b>	<b>3.4172</b>	<b>4.2795</b>	<b>7.6967</b>	<b>1,152.7957</b>	<b>23,447.8243</b>	<b>24,600.6200</b>	<b>49.6069</b>	<b>0.2661</b>	<b>25,920.0879</b>

	ROG	NOx	CO	SO2	Fugitive PM10	Exhaust PM10	PM10 Total	Fugitive PM2.5	Exhaust PM2.5	PM2.5 Total	Bio- CO2	NBio-CO2	Total CO2	CH4	N2O	CO2e
<b>Percent Reduction</b>	<b>0.00</b>	<b>0.00</b>	<b>0.00</b>	<b>0.00</b>	<b>0.00</b>	<b>0.00</b>	<b>0.00</b>	<b>0.00</b>	<b>0.00</b>	<b>0.00</b>	<b>1.06</b>	<b>6.61</b>	<b>6.36</b>	<b>2.63</b>	<b>15.06</b>	<b>6.22</b>

**3.0 Construction Detail**

**Construction Phase**

## Rezoning Sites for Housing Project - Sonoma County - GHG Analysis - Sonoma-San Francisco County, Annual

Phase Number	Phase Name	Phase Type	Start Date	End Date	Num Days Week	Num Days	Phase Description
1	Demolition	Demolition	1/1/2021	7/29/2021	5	150	
2	Site Preparation	Site Preparation	7/30/2021	2/24/2022	5	150	
3	Grading	Grading	2/25/2022	11/16/2023	5	450	
4	Building Construction	Building Construction	11/17/2023	9/16/2027	5	1000	
5	Paving	Paving	9/17/2027	11/9/2028	5	300	
6	Architectural Coating	Architectural Coating	11/10/2028	1/3/2030	5	300	

**Acres of Grading (Site Preparation Phase): 0**

**Acres of Grading (Grading Phase): 1125**

**Acres of Paving: 0**

**Residential Indoor: 10,843,875; Residential Outdoor: 3,614,625; Non-Residential Indoor: 0; Non-Residential Outdoor: 0; Striped Parking Area: 0 (Architectural Coating – sqft)**

**OffRoad Equipment**

## Rezoning Sites for Housing Project - Sonoma County - GHG Analysis - Sonoma-San Francisco County, Annual

Phase Name	Offroad Equipment Type	Amount	Usage Hours	Horse Power	Load Factor
Demolition	Concrete/Industrial Saws	1	8.00	81	0.73
Demolition	Excavators	3	8.00	158	0.38
Demolition	Rubber Tired Dozers	2	8.00	247	0.40
Site Preparation	Rubber Tired Dozers	3	8.00	247	0.40
Site Preparation	Tractors/Loaders/Backhoes	4	8.00	97	0.37
Grading	Excavators	2	8.00	158	0.38
Grading	Graders	1	8.00	187	0.41
Grading	Rubber Tired Dozers	1	8.00	247	0.40
Grading	Scrapers	2	8.00	367	0.48
Grading	Tractors/Loaders/Backhoes	2	8.00	97	0.37
Building Construction	Cranes	1	7.00	231	0.29
Building Construction	Forklifts	3	8.00	89	0.20
Building Construction	Generator Sets	1	8.00	84	0.74
Building Construction	Tractors/Loaders/Backhoes	3	7.00	97	0.37
Building Construction	Welders	1	8.00	46	0.45
Paving	Pavers	2	8.00	130	0.42
Paving	Paving Equipment	2	8.00	132	0.36
Paving	Rollers	2	8.00	80	0.38
Architectural Coating	Air Compressors	1	6.00	78	0.48

**Trips and VMT**



Rezoning Sites for Housing Project - Sonoma County - GHG Analysis - Sonoma-San Francisco County, Annual

Phase Name	Offroad Equipment Count	Worker Trip Number	Vendor Trip Number	Hauling Trip Number	Worker Trip Length	Vendor Trip Length	Hauling Trip Length	Worker Vehicle Class	Vendor Vehicle Class	Hauling Vehicle Class
Demolition	6	15.00	0.00	3,411.00	10.80	7.30	20.00	LD_Mix	HDT_Mix	HHDT
Site Preparation	7	18.00	0.00	0.00	10.80	7.30	20.00	LD_Mix	HDT_Mix	HHDT
Grading	8	20.00	0.00	10,800.00	10.80	7.30	20.00	LD_Mix	HDT_Mix	HHDT
Building Construction	9	1,071.00	318.00	0.00	10.80	7.30	20.00	LD_Mix	HDT_Mix	HHDT
Paving	6	15.00	0.00	0.00	10.80	7.30	20.00	LD_Mix	HDT_Mix	HHDT
Architectural Coating	1	214.00	0.00	0.00	10.80	7.30	20.00	LD_Mix	HDT_Mix	HHDT

**3.1 Mitigation Measures Construction**

Water Exposed Area

Reduce Vehicle Speed on Unpaved Roads

**3.2 Demolition - 2021**

**Unmitigated Construction On-Site**

	ROG	NOx	CO	SO2	Fugitive PM10	Exhaust PM10	PM10 Total	Fugitive PM2.5	Exhaust PM2.5	PM2.5 Total	Bio- CO2	NBio- CO2	Total CO2	CH4	N2O	CO2e
Category	tons/yr										MT/yr					
Fugitive Dust					0.3691	0.0000	0.3691	0.0559	0.0000	0.0559	0.0000	0.0000	0.0000	0.0000	0.0000	0.0000
Off-Road	0.2374	2.3581	1.6174	2.9100e-003		0.1164	0.1164		0.1081	0.1081	0.0000	255.0059	255.0059	0.0718	0.0000	256.8002
<b>Total</b>	<b>0.2374</b>	<b>2.3581</b>	<b>1.6174</b>	<b>2.9100e-003</b>	<b>0.3691</b>	<b>0.1164</b>	<b>0.4855</b>	<b>0.0559</b>	<b>0.1081</b>	<b>0.1640</b>	<b>0.0000</b>	<b>255.0059</b>	<b>255.0059</b>	<b>0.0718</b>	<b>0.0000</b>	<b>256.8002</b>

Rezoning Sites for Housing Project - Sonoma County - GHG Analysis - Sonoma-San Francisco County, Annual

**3.2 Demolition - 2021**

**Unmitigated Construction Off-Site**

	ROG	NOx	CO	SO2	Fugitive PM10	Exhaust PM10	PM10 Total	Fugitive PM2.5	Exhaust PM2.5	PM2.5 Total	Bio- CO2	NBio- CO2	Total CO2	CH4	N2O	CO2e
Category	tons/yr										MT/yr					
Hauling	0.0128	0.4636	0.0986	1.3300e-003	0.0283	1.5800e-003	0.0299	7.7500e-003	1.5100e-003	9.2600e-003	0.0000	129.6649	129.6649	7.9800e-003	0.0000	129.8644
Vendor	0.0000	0.0000	0.0000	0.0000	0.0000	0.0000	0.0000	0.0000	0.0000	0.0000	0.0000	0.0000	0.0000	0.0000	0.0000	0.0000
Worker	4.9700e-003	3.4700e-003	0.0355	9.0000e-005	8.8300e-003	7.0000e-005	8.9000e-003	2.3500e-003	6.0000e-005	2.4100e-003	0.0000	7.8520	7.8520	2.7000e-004	0.0000	7.8586
<b>Total</b>	<b>0.0178</b>	<b>0.4670</b>	<b>0.1340</b>	<b>1.4200e-003</b>	<b>0.0371</b>	<b>1.6500e-003</b>	<b>0.0388</b>	<b>0.0101</b>	<b>1.5700e-003</b>	<b>0.0117</b>	<b>0.0000</b>	<b>137.5168</b>	<b>137.5168</b>	<b>8.2500e-003</b>	<b>0.0000</b>	<b>137.7230</b>

**Mitigated Construction On-Site**

	ROG	NOx	CO	SO2	Fugitive PM10	Exhaust PM10	PM10 Total	Fugitive PM2.5	Exhaust PM2.5	PM2.5 Total	Bio- CO2	NBio- CO2	Total CO2	CH4	N2O	CO2e
Category	tons/yr										MT/yr					
Fugitive Dust					0.1661	0.0000	0.1661	0.0252	0.0000	0.0252	0.0000	0.0000	0.0000	0.0000	0.0000	0.0000
Off-Road	0.2374	2.3581	1.6174	2.9100e-003		0.1164	0.1164		0.1081	0.1081	0.0000	255.0056	255.0056	0.0718	0.0000	256.7999
<b>Total</b>	<b>0.2374</b>	<b>2.3581</b>	<b>1.6174</b>	<b>2.9100e-003</b>	<b>0.1661</b>	<b>0.1164</b>	<b>0.2825</b>	<b>0.0252</b>	<b>0.1081</b>	<b>0.1332</b>	<b>0.0000</b>	<b>255.0056</b>	<b>255.0056</b>	<b>0.0718</b>	<b>0.0000</b>	<b>256.7999</b>

Rezoning Sites for Housing Project - Sonoma County - GHG Analysis - Sonoma-San Francisco County, Annual

**3.2 Demolition - 2021**

**Mitigated Construction Off-Site**

Category	ROG	NOx	CO	SO2	Fugitive PM10	Exhaust PM10	PM10 Total	Fugitive PM2.5	Exhaust PM2.5	PM2.5 Total	Bio- CO2	NBio- CO2	Total CO2	CH4	N2O	CO2e
	tons/yr										MT/yr					
Hauling	0.0128	0.4636	0.0986	1.3300e-003	0.0283	1.5800e-003	0.0299	7.7500e-003	1.5100e-003	9.2600e-003	0.0000	129.6649	129.6649	7.9800e-003	0.0000	129.8644
Vendor	0.0000	0.0000	0.0000	0.0000	0.0000	0.0000	0.0000	0.0000	0.0000	0.0000	0.0000	0.0000	0.0000	0.0000	0.0000	0.0000
Worker	4.9700e-003	3.4700e-003	0.0355	9.0000e-005	8.8300e-003	7.0000e-005	8.9000e-003	2.3500e-003	6.0000e-005	2.4100e-003	0.0000	7.8520	7.8520	2.7000e-004	0.0000	7.8586
<b>Total</b>	<b>0.0178</b>	<b>0.4670</b>	<b>0.1340</b>	<b>1.4200e-003</b>	<b>0.0371</b>	<b>1.6500e-003</b>	<b>0.0388</b>	<b>0.0101</b>	<b>1.5700e-003</b>	<b>0.0117</b>	<b>0.0000</b>	<b>137.5168</b>	<b>137.5168</b>	<b>8.2500e-003</b>	<b>0.0000</b>	<b>137.7230</b>

**3.3 Site Preparation - 2021**

**Unmitigated Construction On-Site**

Category	ROG	NOx	CO	SO2	Fugitive PM10	Exhaust PM10	PM10 Total	Fugitive PM2.5	Exhaust PM2.5	PM2.5 Total	Bio- CO2	NBio- CO2	Total CO2	CH4	N2O	CO2e
	tons/yr										MT/yr					
Fugitive Dust					1.0027	0.0000	1.0027	0.5512	0.0000	0.5512	0.0000	0.0000	0.0000	0.0000	0.0000	0.0000
Off-Road	0.2158	2.2476	1.1741	2.1100e-003		0.1135	0.1135		0.1044	0.1044	0.0000	185.5682	185.5682	0.0600	0.0000	187.0686
<b>Total</b>	<b>0.2158</b>	<b>2.2476</b>	<b>1.1741</b>	<b>2.1100e-003</b>	<b>1.0027</b>	<b>0.1135</b>	<b>1.1162</b>	<b>0.5512</b>	<b>0.1044</b>	<b>0.6555</b>	<b>0.0000</b>	<b>185.5682</b>	<b>185.5682</b>	<b>0.0600</b>	<b>0.0000</b>	<b>187.0686</b>

Rezoning Sites for Housing Project - Sonoma County - GHG Analysis - Sonoma-San Francisco County, Annual

**3.3 Site Preparation - 2021**

**Unmitigated Construction Off-Site**

	ROG	NOx	CO	SO2	Fugitive PM10	Exhaust PM10	PM10 Total	Fugitive PM2.5	Exhaust PM2.5	PM2.5 Total	Bio- CO2	NBio- CO2	Total CO2	CH4	N2O	CO2e
Category	tons/yr										MT/yr					
Hauling	0.0000	0.0000	0.0000	0.0000	0.0000	0.0000	0.0000	0.0000	0.0000	0.0000	0.0000	0.0000	0.0000	0.0000	0.0000	0.0000
Vendor	0.0000	0.0000	0.0000	0.0000	0.0000	0.0000	0.0000	0.0000	0.0000	0.0000	0.0000	0.0000	0.0000	0.0000	0.0000	0.0000
Worker	4.4200e-003	3.0900e-003	0.0315	8.0000e-005	7.8400e-003	6.0000e-005	7.9000e-003	2.0900e-003	6.0000e-005	2.1400e-003	0.0000	6.9726	6.9726	2.4000e-004	0.0000	6.9784
<b>Total</b>	<b>4.4200e-003</b>	<b>3.0900e-003</b>	<b>0.0315</b>	<b>8.0000e-005</b>	<b>7.8400e-003</b>	<b>6.0000e-005</b>	<b>7.9000e-003</b>	<b>2.0900e-003</b>	<b>6.0000e-005</b>	<b>2.1400e-003</b>	<b>0.0000</b>	<b>6.9726</b>	<b>6.9726</b>	<b>2.4000e-004</b>	<b>0.0000</b>	<b>6.9784</b>

**Mitigated Construction On-Site**

	ROG	NOx	CO	SO2	Fugitive PM10	Exhaust PM10	PM10 Total	Fugitive PM2.5	Exhaust PM2.5	PM2.5 Total	Bio- CO2	NBio- CO2	Total CO2	CH4	N2O	CO2e
Category	tons/yr										MT/yr					
Fugitive Dust					0.4512	0.0000	0.4512	0.2480	0.0000	0.2480	0.0000	0.0000	0.0000	0.0000	0.0000	0.0000
Off-Road	0.2158	2.2476	1.1741	2.1100e-003		0.1135	0.1135		0.1044	0.1044	0.0000	185.5680	185.5680	0.0600	0.0000	187.0684
<b>Total</b>	<b>0.2158</b>	<b>2.2476</b>	<b>1.1741</b>	<b>2.1100e-003</b>	<b>0.4512</b>	<b>0.1135</b>	<b>0.5647</b>	<b>0.2480</b>	<b>0.1044</b>	<b>0.3524</b>	<b>0.0000</b>	<b>185.5680</b>	<b>185.5680</b>	<b>0.0600</b>	<b>0.0000</b>	<b>187.0684</b>

Rezoning Sites for Housing Project - Sonoma County - GHG Analysis - Sonoma-San Francisco County, Annual

**3.3 Site Preparation - 2021**

**Mitigated Construction Off-Site**

	ROG	NOx	CO	SO2	Fugitive PM10	Exhaust PM10	PM10 Total	Fugitive PM2.5	Exhaust PM2.5	PM2.5 Total	Bio- CO2	NBio- CO2	Total CO2	CH4	N2O	CO2e
Category	tons/yr										MT/yr					
Hauling	0.0000	0.0000	0.0000	0.0000	0.0000	0.0000	0.0000	0.0000	0.0000	0.0000	0.0000	0.0000	0.0000	0.0000	0.0000	0.0000
Vendor	0.0000	0.0000	0.0000	0.0000	0.0000	0.0000	0.0000	0.0000	0.0000	0.0000	0.0000	0.0000	0.0000	0.0000	0.0000	0.0000
Worker	4.4200e-003	3.0900e-003	0.0315	8.0000e-005	7.8400e-003	6.0000e-005	7.9000e-003	2.0900e-003	6.0000e-005	2.1400e-003	0.0000	6.9726	6.9726	2.4000e-004	0.0000	6.9784
<b>Total</b>	<b>4.4200e-003</b>	<b>3.0900e-003</b>	<b>0.0315</b>	<b>8.0000e-005</b>	<b>7.8400e-003</b>	<b>6.0000e-005</b>	<b>7.9000e-003</b>	<b>2.0900e-003</b>	<b>6.0000e-005</b>	<b>2.1400e-003</b>	<b>0.0000</b>	<b>6.9726</b>	<b>6.9726</b>	<b>2.4000e-004</b>	<b>0.0000</b>	<b>6.9784</b>

**3.3 Site Preparation - 2022**

**Unmitigated Construction On-Site**

	ROG	NOx	CO	SO2	Fugitive PM10	Exhaust PM10	PM10 Total	Fugitive PM2.5	Exhaust PM2.5	PM2.5 Total	Bio- CO2	NBio- CO2	Total CO2	CH4	N2O	CO2e
Category	tons/yr										MT/yr					
Fugitive Dust					0.3523	0.0000	0.3523	0.1937	0.0000	0.1937	0.0000	0.0000	0.0000	0.0000	0.0000	0.0000
Off-Road	0.0618	0.6451	0.3841	7.4000e-004		0.0315	0.0315		0.0289	0.0289	0.0000	65.2068	65.2068	0.0211	0.0000	65.7340
<b>Total</b>	<b>0.0618</b>	<b>0.6451</b>	<b>0.3841</b>	<b>7.4000e-004</b>	<b>0.3523</b>	<b>0.0315</b>	<b>0.3837</b>	<b>0.1937</b>	<b>0.0289</b>	<b>0.2226</b>	<b>0.0000</b>	<b>65.2068</b>	<b>65.2068</b>	<b>0.0211</b>	<b>0.0000</b>	<b>65.7340</b>

Rezoning Sites for Housing Project - Sonoma County - GHG Analysis - Sonoma-San Francisco County, Annual

**3.3 Site Preparation - 2022**

**Unmitigated Construction Off-Site**

	ROG	NOx	CO	SO2	Fugitive PM10	Exhaust PM10	PM10 Total	Fugitive PM2.5	Exhaust PM2.5	PM2.5 Total	Bio- CO2	NBio- CO2	Total CO2	CH4	N2O	CO2e
Category	tons/yr										MT/yr					
Hauling	0.0000	0.0000	0.0000	0.0000	0.0000	0.0000	0.0000	0.0000	0.0000	0.0000	0.0000	0.0000	0.0000	0.0000	0.0000	0.0000
Vendor	0.0000	0.0000	0.0000	0.0000	0.0000	0.0000	0.0000	0.0000	0.0000	0.0000	0.0000	0.0000	0.0000	0.0000	0.0000	0.0000
Worker	1.4400e-003	9.6000e-004	9.9100e-003	3.0000e-005	2.7500e-003	2.0000e-005	2.7800e-003	7.3000e-004	2.0000e-005	7.5000e-004	0.0000	2.3602	2.3602	7.0000e-005	0.0000	2.3620
<b>Total</b>	<b>1.4400e-003</b>	<b>9.6000e-004</b>	<b>9.9100e-003</b>	<b>3.0000e-005</b>	<b>2.7500e-003</b>	<b>2.0000e-005</b>	<b>2.7800e-003</b>	<b>7.3000e-004</b>	<b>2.0000e-005</b>	<b>7.5000e-004</b>	<b>0.0000</b>	<b>2.3602</b>	<b>2.3602</b>	<b>7.0000e-005</b>	<b>0.0000</b>	<b>2.3620</b>

**Mitigated Construction On-Site**

	ROG	NOx	CO	SO2	Fugitive PM10	Exhaust PM10	PM10 Total	Fugitive PM2.5	Exhaust PM2.5	PM2.5 Total	Bio- CO2	NBio- CO2	Total CO2	CH4	N2O	CO2e
Category	tons/yr										MT/yr					
Fugitive Dust					0.1585	0.0000	0.1585	0.0871	0.0000	0.0871	0.0000	0.0000	0.0000	0.0000	0.0000	0.0000
Off-Road	0.0618	0.6451	0.3841	7.4000e-004		0.0315	0.0315		0.0289	0.0289	0.0000	65.2067	65.2067	0.0211	0.0000	65.7340
<b>Total</b>	<b>0.0618</b>	<b>0.6451</b>	<b>0.3841</b>	<b>7.4000e-004</b>	<b>0.1585</b>	<b>0.0315</b>	<b>0.1900</b>	<b>0.0871</b>	<b>0.0289</b>	<b>0.1161</b>	<b>0.0000</b>	<b>65.2067</b>	<b>65.2067</b>	<b>0.0211</b>	<b>0.0000</b>	<b>65.7340</b>

Rezoning Sites for Housing Project - Sonoma County - GHG Analysis - Sonoma-San Francisco County, Annual

**3.3 Site Preparation - 2022**

**Mitigated Construction Off-Site**

	ROG	NOx	CO	SO2	Fugitive PM10	Exhaust PM10	PM10 Total	Fugitive PM2.5	Exhaust PM2.5	PM2.5 Total	Bio- CO2	NBio- CO2	Total CO2	CH4	N2O	CO2e
Category	tons/yr										MT/yr					
Hauling	0.0000	0.0000	0.0000	0.0000	0.0000	0.0000	0.0000	0.0000	0.0000	0.0000	0.0000	0.0000	0.0000	0.0000	0.0000	0.0000
Vendor	0.0000	0.0000	0.0000	0.0000	0.0000	0.0000	0.0000	0.0000	0.0000	0.0000	0.0000	0.0000	0.0000	0.0000	0.0000	0.0000
Worker	1.4400e-003	9.6000e-004	9.9100e-003	3.0000e-005	2.7500e-003	2.0000e-005	2.7800e-003	7.3000e-004	2.0000e-005	7.5000e-004	0.0000	2.3602	2.3602	7.0000e-005	0.0000	2.3620
<b>Total</b>	<b>1.4400e-003</b>	<b>9.6000e-004</b>	<b>9.9100e-003</b>	<b>3.0000e-005</b>	<b>2.7500e-003</b>	<b>2.0000e-005</b>	<b>2.7800e-003</b>	<b>7.3000e-004</b>	<b>2.0000e-005</b>	<b>7.5000e-004</b>	<b>0.0000</b>	<b>2.3602</b>	<b>2.3602</b>	<b>7.0000e-005</b>	<b>0.0000</b>	<b>2.3620</b>

**3.4 Grading - 2022**

**Unmitigated Construction On-Site**

	ROG	NOx	CO	SO2	Fugitive PM10	Exhaust PM10	PM10 Total	Fugitive PM2.5	Exhaust PM2.5	PM2.5 Total	Bio- CO2	NBio- CO2	Total CO2	CH4	N2O	CO2e
Category	tons/yr										MT/yr					
Fugitive Dust					1.2669	0.0000	1.2669	0.4309	0.0000	0.4309	0.0000	0.0000	0.0000	0.0000	0.0000	0.0000
Off-Road	0.4005	4.2922	3.2091	6.8600e-003		0.1807	0.1807		0.1662	0.1662	0.0000	602.6073	602.6073	0.1949	0.0000	607.4797
<b>Total</b>	<b>0.4005</b>	<b>4.2922</b>	<b>3.2091</b>	<b>6.8600e-003</b>	<b>1.2669</b>	<b>0.1807</b>	<b>1.4475</b>	<b>0.4309</b>	<b>0.1662</b>	<b>0.5971</b>	<b>0.0000</b>	<b>602.6073</b>	<b>602.6073</b>	<b>0.1949</b>	<b>0.0000</b>	<b>607.4797</b>

Rezoning Sites for Housing Project - Sonoma County - GHG Analysis - Sonoma-San Francisco County, Annual

**3.4 Grading - 2022**

**Unmitigated Construction Off-Site**

	ROG	NOx	CO	SO2	Fugitive PM10	Exhaust PM10	PM10 Total	Fugitive PM2.5	Exhaust PM2.5	PM2.5 Total	Bio- CO2	NBio- CO2	Total CO2	CH4	N2O	CO2e
Category	tons/yr										MT/yr					
Hauling	0.0187	0.6604	0.1473	2.0300e-003	0.0784	2.1100e-003	0.0805	0.0205	2.0100e-003	0.0225	0.0000	198.8723	198.8723	0.0123	0.0000	199.1793
Vendor	0.0000	0.0000	0.0000	0.0000	0.0000	0.0000	0.0000	0.0000	0.0000	0.0000	0.0000	0.0000	0.0000	0.0000	0.0000	0.0000
Worker	9.0500e-003	6.0600e-003	0.0624	1.6000e-004	0.0173	1.3000e-004	0.0175	4.6200e-003	1.2000e-004	4.7400e-003	0.0000	14.8604	14.8604	4.6000e-004	0.0000	14.8719
<b>Total</b>	<b>0.0278</b>	<b>0.6664</b>	<b>0.2097</b>	<b>2.1900e-003</b>	<b>0.0958</b>	<b>2.2400e-003</b>	<b>0.0980</b>	<b>0.0251</b>	<b>2.1300e-003</b>	<b>0.0273</b>	<b>0.0000</b>	<b>213.7327</b>	<b>213.7327</b>	<b>0.0127</b>	<b>0.0000</b>	<b>214.0511</b>

**Mitigated Construction On-Site**

	ROG	NOx	CO	SO2	Fugitive PM10	Exhaust PM10	PM10 Total	Fugitive PM2.5	Exhaust PM2.5	PM2.5 Total	Bio- CO2	NBio- CO2	Total CO2	CH4	N2O	CO2e
Category	tons/yr										MT/yr					
Fugitive Dust					0.5701	0.0000	0.5701	0.1939	0.0000	0.1939	0.0000	0.0000	0.0000	0.0000	0.0000	0.0000
Off-Road	0.4005	4.2922	3.2091	6.8600e-003		0.1807	0.1807		0.1662	0.1662	0.0000	602.6066	602.6066	0.1949	0.0000	607.4790
<b>Total</b>	<b>0.4005</b>	<b>4.2922</b>	<b>3.2091</b>	<b>6.8600e-003</b>	<b>0.5701</b>	<b>0.1807</b>	<b>0.7507</b>	<b>0.1939</b>	<b>0.1662</b>	<b>0.3601</b>	<b>0.0000</b>	<b>602.6066</b>	<b>602.6066</b>	<b>0.1949</b>	<b>0.0000</b>	<b>607.4790</b>



Rezoning Sites for Housing Project - Sonoma County - GHG Analysis - Sonoma-San Francisco County, Annual

**3.4 Grading - 2022**

**Mitigated Construction Off-Site**

	ROG	NOx	CO	SO2	Fugitive PM10	Exhaust PM10	PM10 Total	Fugitive PM2.5	Exhaust PM2.5	PM2.5 Total	Bio- CO2	NBio- CO2	Total CO2	CH4	N2O	CO2e
Category	tons/yr										MT/yr					
Hauling	0.0187	0.6604	0.1473	2.0300e-003	0.0784	2.1100e-003	0.0805	0.0205	2.0100e-003	0.0225	0.0000	198.8723	198.8723	0.0123	0.0000	199.1793
Vendor	0.0000	0.0000	0.0000	0.0000	0.0000	0.0000	0.0000	0.0000	0.0000	0.0000	0.0000	0.0000	0.0000	0.0000	0.0000	0.0000
Worker	9.0500e-003	6.0600e-003	0.0624	1.6000e-004	0.0173	1.3000e-004	0.0175	4.6200e-003	1.2000e-004	4.7400e-003	0.0000	14.8604	14.8604	4.6000e-004	0.0000	14.8719
<b>Total</b>	<b>0.0278</b>	<b>0.6664</b>	<b>0.2097</b>	<b>2.1900e-003</b>	<b>0.0958</b>	<b>2.2400e-003</b>	<b>0.0980</b>	<b>0.0251</b>	<b>2.1300e-003</b>	<b>0.0273</b>	<b>0.0000</b>	<b>213.7327</b>	<b>213.7327</b>	<b>0.0127</b>	<b>0.0000</b>	<b>214.0511</b>

**3.4 Grading - 2023**

**Unmitigated Construction On-Site**

	ROG	NOx	CO	SO2	Fugitive PM10	Exhaust PM10	PM10 Total	Fugitive PM2.5	Exhaust PM2.5	PM2.5 Total	Bio- CO2	NBio- CO2	Total CO2	CH4	N2O	CO2e
Category	tons/yr										MT/yr					
Fugitive Dust					1.2910	0.0000	1.2910	0.4442	0.0000	0.4442	0.0000	0.0000	0.0000	0.0000	0.0000	0.0000
Off-Road	0.3803	3.9520	3.2119	7.1100e-003		0.1631	0.1631		0.1501	0.1501	0.0000	624.4281	624.4281	0.2020	0.0000	629.4770
<b>Total</b>	<b>0.3803</b>	<b>3.9520</b>	<b>3.2119</b>	<b>7.1100e-003</b>	<b>1.2910</b>	<b>0.1631</b>	<b>1.4541</b>	<b>0.4442</b>	<b>0.1501</b>	<b>0.5942</b>	<b>0.0000</b>	<b>624.4281</b>	<b>624.4281</b>	<b>0.2020</b>	<b>0.0000</b>	<b>629.4770</b>

Rezoning Sites for Housing Project - Sonoma County - GHG Analysis - Sonoma-San Francisco County, Annual

**3.4 Grading - 2023**

**Unmitigated Construction Off-Site**

	ROG	NOx	CO	SO2	Fugitive PM10	Exhaust PM10	PM10 Total	Fugitive PM2.5	Exhaust PM2.5	PM2.5 Total	Bio- CO2	NBio- CO2	Total CO2	CH4	N2O	CO2e
Category	tons/yr										MT/yr					
Hauling	0.0137	0.4760	0.1393	2.0400e-003	0.0788	9.5000e-004	0.0798	0.0206	9.1000e-004	0.0216	0.0000	199.4761	199.4761	0.0118	0.0000	199.7702
Vendor	0.0000	0.0000	0.0000	0.0000	0.0000	0.0000	0.0000	0.0000	0.0000	0.0000	0.0000	0.0000	0.0000	0.0000	0.0000	0.0000
Worker	8.7000e-003	5.6000e-003	0.0582	1.6000e-004	0.0180	1.3000e-004	0.0181	4.7800e-003	1.2000e-004	4.9000e-003	0.0000	14.8057	14.8057	4.2000e-004	0.0000	14.8162
<b>Total</b>	<b>0.0224</b>	<b>0.4816</b>	<b>0.1975</b>	<b>2.2000e-003</b>	<b>0.0968</b>	<b>1.0800e-003</b>	<b>0.0979</b>	<b>0.0254</b>	<b>1.0300e-003</b>	<b>0.0265</b>	<b>0.0000</b>	<b>214.2819</b>	<b>214.2819</b>	<b>0.0122</b>	<b>0.0000</b>	<b>214.5865</b>

**Mitigated Construction On-Site**

	ROG	NOx	CO	SO2	Fugitive PM10	Exhaust PM10	PM10 Total	Fugitive PM2.5	Exhaust PM2.5	PM2.5 Total	Bio- CO2	NBio- CO2	Total CO2	CH4	N2O	CO2e
Category	tons/yr										MT/yr					
Fugitive Dust					0.5809	0.0000	0.5809	0.1999	0.0000	0.1999	0.0000	0.0000	0.0000	0.0000	0.0000	0.0000
Off-Road	0.3803	3.9520	3.2119	7.1100e-003		0.1631	0.1631		0.1501	0.1501	0.0000	624.4274	624.4274	0.2020	0.0000	629.4762
<b>Total</b>	<b>0.3803</b>	<b>3.9520</b>	<b>3.2119</b>	<b>7.1100e-003</b>	<b>0.5809</b>	<b>0.1631</b>	<b>0.7440</b>	<b>0.1999</b>	<b>0.1501</b>	<b>0.3499</b>	<b>0.0000</b>	<b>624.4274</b>	<b>624.4274</b>	<b>0.2020</b>	<b>0.0000</b>	<b>629.4762</b>

Rezoning Sites for Housing Project - Sonoma County - GHG Analysis - Sonoma-San Francisco County, Annual

**3.4 Grading - 2023**

**Mitigated Construction Off-Site**

	ROG	NOx	CO	SO2	Fugitive PM10	Exhaust PM10	PM10 Total	Fugitive PM2.5	Exhaust PM2.5	PM2.5 Total	Bio- CO2	NBio- CO2	Total CO2	CH4	N2O	CO2e
Category	tons/yr										MT/yr					
Hauling	0.0137	0.4760	0.1393	2.0400e-003	0.0788	9.5000e-004	0.0798	0.0206	9.1000e-004	0.0216	0.0000	199.4761	199.4761	0.0118	0.0000	199.7702
Vendor	0.0000	0.0000	0.0000	0.0000	0.0000	0.0000	0.0000	0.0000	0.0000	0.0000	0.0000	0.0000	0.0000	0.0000	0.0000	0.0000
Worker	8.7000e-003	5.6000e-003	0.0582	1.6000e-004	0.0180	1.3000e-004	0.0181	4.7800e-003	1.2000e-004	4.9000e-003	0.0000	14.8057	14.8057	4.2000e-004	0.0000	14.8162
<b>Total</b>	<b>0.0224</b>	<b>0.4816</b>	<b>0.1975</b>	<b>2.2000e-003</b>	<b>0.0968</b>	<b>1.0800e-003</b>	<b>0.0979</b>	<b>0.0254</b>	<b>1.0300e-003</b>	<b>0.0265</b>	<b>0.0000</b>	<b>214.2819</b>	<b>214.2819</b>	<b>0.0122</b>	<b>0.0000</b>	<b>214.5865</b>

**3.5 Building Construction - 2023**

**Unmitigated Construction On-Site**

	ROG	NOx	CO	SO2	Fugitive PM10	Exhaust PM10	PM10 Total	Fugitive PM2.5	Exhaust PM2.5	PM2.5 Total	Bio- CO2	NBio- CO2	Total CO2	CH4	N2O	CO2e
Category	tons/yr										MT/yr					
Off-Road	0.0244	0.2230	0.2518	4.2000e-004		0.0109	0.0109		0.0102	0.0102	0.0000	35.9297	35.9297	8.5500e-003	0.0000	36.1434
<b>Total</b>	<b>0.0244</b>	<b>0.2230</b>	<b>0.2518</b>	<b>4.2000e-004</b>		<b>0.0109</b>	<b>0.0109</b>		<b>0.0102</b>	<b>0.0102</b>	<b>0.0000</b>	<b>35.9297</b>	<b>35.9297</b>	<b>8.5500e-003</b>	<b>0.0000</b>	<b>36.1434</b>

Rezoning Sites for Housing Project - Sonoma County - GHG Analysis - Sonoma-San Francisco County, Annual

**3.5 Building Construction - 2023**

**Unmitigated Construction Off-Site**

	ROG	NOx	CO	SO2	Fugitive PM10	Exhaust PM10	PM10 Total	Fugitive PM2.5	Exhaust PM2.5	PM2.5 Total	Bio- CO2	NBio- CO2	Total CO2	CH4	N2O	CO2e
Category	tons/yr										MT/yr					
Hauling	0.0000	0.0000	0.0000	0.0000	0.0000	0.0000	0.0000	0.0000	0.0000	0.0000	0.0000	0.0000	0.0000	0.0000	0.0000	0.0000
Vendor	0.0109	0.4072	0.1068	1.2600e-003	0.0320	5.1000e-004	0.0325	9.2300e-003	4.9000e-004	9.7200e-003	0.0000	121.7621	121.7621	6.4300e-003	0.0000	121.9229
Worker	0.0631	0.0406	0.4217	1.1900e-003	0.1303	9.4000e-004	0.1312	0.0347	8.7000e-004	0.0356	0.0000	107.3285	107.3285	3.0500e-003	0.0000	107.4046
<b>Total</b>	<b>0.0740</b>	<b>0.4478</b>	<b>0.5285</b>	<b>2.4500e-003</b>	<b>0.1622</b>	<b>1.4500e-003</b>	<b>0.1637</b>	<b>0.0439</b>	<b>1.3600e-003</b>	<b>0.0453</b>	<b>0.0000</b>	<b>229.0906</b>	<b>229.0906</b>	<b>9.4800e-003</b>	<b>0.0000</b>	<b>229.3275</b>

**Mitigated Construction On-Site**

	ROG	NOx	CO	SO2	Fugitive PM10	Exhaust PM10	PM10 Total	Fugitive PM2.5	Exhaust PM2.5	PM2.5 Total	Bio- CO2	NBio- CO2	Total CO2	CH4	N2O	CO2e
Category	tons/yr										MT/yr					
Off-Road	0.0244	0.2230	0.2518	4.2000e-004		0.0109	0.0109		0.0102	0.0102	0.0000	35.9297	35.9297	8.5500e-003	0.0000	36.1434
<b>Total</b>	<b>0.0244</b>	<b>0.2230</b>	<b>0.2518</b>	<b>4.2000e-004</b>		<b>0.0109</b>	<b>0.0109</b>		<b>0.0102</b>	<b>0.0102</b>	<b>0.0000</b>	<b>35.9297</b>	<b>35.9297</b>	<b>8.5500e-003</b>	<b>0.0000</b>	<b>36.1434</b>

Rezoning Sites for Housing Project - Sonoma County - GHG Analysis - Sonoma-San Francisco County, Annual

**3.5 Building Construction - 2023**

**Mitigated Construction Off-Site**

	ROG	NOx	CO	SO2	Fugitive PM10	Exhaust PM10	PM10 Total	Fugitive PM2.5	Exhaust PM2.5	PM2.5 Total	Bio- CO2	NBio- CO2	Total CO2	CH4	N2O	CO2e
Category	tons/yr										MT/yr					
Hauling	0.0000	0.0000	0.0000	0.0000	0.0000	0.0000	0.0000	0.0000	0.0000	0.0000	0.0000	0.0000	0.0000	0.0000	0.0000	0.0000
Vendor	0.0109	0.4072	0.1068	1.2600e-003	0.0320	5.1000e-004	0.0325	9.2300e-003	4.9000e-004	9.7200e-003	0.0000	121.7621	121.7621	6.4300e-003	0.0000	121.9229
Worker	0.0631	0.0406	0.4217	1.1900e-003	0.1303	9.4000e-004	0.1312	0.0347	8.7000e-004	0.0356	0.0000	107.3285	107.3285	3.0500e-003	0.0000	107.4046
<b>Total</b>	<b>0.0740</b>	<b>0.4478</b>	<b>0.5285</b>	<b>2.4500e-003</b>	<b>0.1622</b>	<b>1.4500e-003</b>	<b>0.1637</b>	<b>0.0439</b>	<b>1.3600e-003</b>	<b>0.0453</b>	<b>0.0000</b>	<b>229.0906</b>	<b>229.0906</b>	<b>9.4800e-003</b>	<b>0.0000</b>	<b>229.3275</b>

**3.5 Building Construction - 2024**

**Unmitigated Construction On-Site**

	ROG	NOx	CO	SO2	Fugitive PM10	Exhaust PM10	PM10 Total	Fugitive PM2.5	Exhaust PM2.5	PM2.5 Total	Bio- CO2	NBio- CO2	Total CO2	CH4	N2O	CO2e
Category	tons/yr										MT/yr					
Off-Road	0.1928	1.7611	2.1179	3.5300e-003		0.0803	0.0803		0.0756	0.0756	0.0000	303.7223	303.7223	0.0718	0.0000	305.5179
<b>Total</b>	<b>0.1928</b>	<b>1.7611</b>	<b>2.1179</b>	<b>3.5300e-003</b>		<b>0.0803</b>	<b>0.0803</b>		<b>0.0756</b>	<b>0.0756</b>	<b>0.0000</b>	<b>303.7223</b>	<b>303.7223</b>	<b>0.0718</b>	<b>0.0000</b>	<b>305.5179</b>

Rezoning Sites for Housing Project - Sonoma County - GHG Analysis - Sonoma-San Francisco County, Annual

**3.5 Building Construction - 2024**

**Unmitigated Construction Off-Site**

	ROG	NOx	CO	SO2	Fugitive PM10	Exhaust PM10	PM10 Total	Fugitive PM2.5	Exhaust PM2.5	PM2.5 Total	Bio- CO2	NBio- CO2	Total CO2	CH4	N2O	CO2e
Category	tons/yr										MT/yr					
Hauling	0.0000	0.0000	0.0000	0.0000	0.0000	0.0000	0.0000	0.0000	0.0000	0.0000	0.0000	0.0000	0.0000	0.0000	0.0000	0.0000
Vendor	0.0884	3.3958	0.8531	0.0106	0.2700	4.1300e-003	0.2741	0.0780	3.9500e-003	0.0820	0.0000	1,022.6468	1,022.6468	0.0537	0.0000	1,023.9901
Worker	0.4949	0.3060	3.2367	9.6300e-003	1.1011	7.7000e-003	1.1088	0.2931	7.1000e-003	0.3002	0.0000	870.7887	870.7887	0.0227	0.0000	871.3551
<b>Total</b>	<b>0.5833</b>	<b>3.7018</b>	<b>4.0898</b>	<b>0.0202</b>	<b>1.3711</b>	<b>0.0118</b>	<b>1.3829</b>	<b>0.3711</b>	<b>0.0111</b>	<b>0.3821</b>	<b>0.0000</b>	<b>1,893.4355</b>	<b>1,893.4355</b>	<b>0.0764</b>	<b>0.0000</b>	<b>1,895.3453</b>

**Mitigated Construction On-Site**

	ROG	NOx	CO	SO2	Fugitive PM10	Exhaust PM10	PM10 Total	Fugitive PM2.5	Exhaust PM2.5	PM2.5 Total	Bio- CO2	NBio- CO2	Total CO2	CH4	N2O	CO2e
Category	tons/yr										MT/yr					
Off-Road	0.1928	1.7611	2.1179	3.5300e-003		0.0803	0.0803		0.0756	0.0756	0.0000	303.7220	303.7220	0.0718	0.0000	305.5175
<b>Total</b>	<b>0.1928</b>	<b>1.7611</b>	<b>2.1179</b>	<b>3.5300e-003</b>		<b>0.0803</b>	<b>0.0803</b>		<b>0.0756</b>	<b>0.0756</b>	<b>0.0000</b>	<b>303.7220</b>	<b>303.7220</b>	<b>0.0718</b>	<b>0.0000</b>	<b>305.5175</b>

Rezoning Sites for Housing Project - Sonoma County - GHG Analysis - Sonoma-San Francisco County, Annual

**3.5 Building Construction - 2024**

**Mitigated Construction Off-Site**

	ROG	NOx	CO	SO2	Fugitive PM10	Exhaust PM10	PM10 Total	Fugitive PM2.5	Exhaust PM2.5	PM2.5 Total	Bio- CO2	NBio- CO2	Total CO2	CH4	N2O	CO2e
Category	tons/yr										MT/yr					
Hauling	0.0000	0.0000	0.0000	0.0000	0.0000	0.0000	0.0000	0.0000	0.0000	0.0000	0.0000	0.0000	0.0000	0.0000	0.0000	0.0000
Vendor	0.0884	3.3958	0.8531	0.0106	0.2700	4.1300e-003	0.2741	0.0780	3.9500e-003	0.0820	0.0000	1,022.6468	1,022.6468	0.0537	0.0000	1,023.9901
Worker	0.4949	0.3060	3.2367	9.6300e-003	1.1011	7.7000e-003	1.1088	0.2931	7.1000e-003	0.3002	0.0000	870.7887	870.7887	0.0227	0.0000	871.3551
<b>Total</b>	<b>0.5833</b>	<b>3.7018</b>	<b>4.0898</b>	<b>0.0202</b>	<b>1.3711</b>	<b>0.0118</b>	<b>1.3829</b>	<b>0.3711</b>	<b>0.0111</b>	<b>0.3821</b>	<b>0.0000</b>	<b>1,893.4355</b>	<b>1,893.4355</b>	<b>0.0764</b>	<b>0.0000</b>	<b>1,895.3453</b>

**3.5 Building Construction - 2025**

**Unmitigated Construction On-Site**

	ROG	NOx	CO	SO2	Fugitive PM10	Exhaust PM10	PM10 Total	Fugitive PM2.5	Exhaust PM2.5	PM2.5 Total	Bio- CO2	NBio- CO2	Total CO2	CH4	N2O	CO2e
Category	tons/yr										MT/yr					
Off-Road	0.1785	1.6273	2.0991	3.5200e-003		0.0689	0.0689		0.0648	0.0648	0.0000	302.6549	302.6549	0.0711	0.0000	304.4335
<b>Total</b>	<b>0.1785</b>	<b>1.6273</b>	<b>2.0991</b>	<b>3.5200e-003</b>		<b>0.0689</b>	<b>0.0689</b>		<b>0.0648</b>	<b>0.0648</b>	<b>0.0000</b>	<b>302.6549</b>	<b>302.6549</b>	<b>0.0711</b>	<b>0.0000</b>	<b>304.4335</b>

Rezoning Sites for Housing Project - Sonoma County - GHG Analysis - Sonoma-San Francisco County, Annual

**3.5 Building Construction - 2025**

**Unmitigated Construction Off-Site**

	ROG	NOx	CO	SO2	Fugitive PM10	Exhaust PM10	PM10 Total	Fugitive PM2.5	Exhaust PM2.5	PM2.5 Total	Bio- CO2	NBio- CO2	Total CO2	CH4	N2O	CO2e
Category	tons/yr										MT/yr					
Hauling	0.0000	0.0000	0.0000	0.0000	0.0000	0.0000	0.0000	0.0000	0.0000	0.0000	0.0000	0.0000	0.0000	0.0000	0.0000	0.0000
Vendor	0.0848	3.3372	0.8133	0.0105	0.2689	3.9600e-003	0.2729	0.0777	3.7900e-003	0.0815	0.0000	1,012.4926	1,012.4926	0.0529	0.0000	1,013.8159
Worker	0.4590	0.2743	2.9493	9.2000e-003	1.0969	7.4800e-003	1.1044	0.2920	6.8900e-003	0.2989	0.0000	831.7436	831.7436	0.0201	0.0000	832.2470
<b>Total</b>	<b>0.5438</b>	<b>3.6115</b>	<b>3.7626</b>	<b>0.0197</b>	<b>1.3658</b>	<b>0.0114</b>	<b>1.3772</b>	<b>0.3697</b>	<b>0.0107</b>	<b>0.3804</b>	<b>0.0000</b>	<b>1,844.2361</b>	<b>1,844.2361</b>	<b>0.0731</b>	<b>0.0000</b>	<b>1,846.0629</b>

**Mitigated Construction On-Site**

	ROG	NOx	CO	SO2	Fugitive PM10	Exhaust PM10	PM10 Total	Fugitive PM2.5	Exhaust PM2.5	PM2.5 Total	Bio- CO2	NBio- CO2	Total CO2	CH4	N2O	CO2e
Category	tons/yr										MT/yr					
Off-Road	0.1784	1.6273	2.0991	3.5200e-003		0.0689	0.0689		0.0648	0.0648	0.0000	302.6545	302.6545	0.0711	0.0000	304.4331
<b>Total</b>	<b>0.1784</b>	<b>1.6273</b>	<b>2.0991</b>	<b>3.5200e-003</b>		<b>0.0689</b>	<b>0.0689</b>		<b>0.0648</b>	<b>0.0648</b>	<b>0.0000</b>	<b>302.6545</b>	<b>302.6545</b>	<b>0.0711</b>	<b>0.0000</b>	<b>304.4331</b>



Rezoning Sites for Housing Project - Sonoma County - GHG Analysis - Sonoma-San Francisco County, Annual

**3.5 Building Construction - 2025**

**Mitigated Construction Off-Site**

	ROG	NOx	CO	SO2	Fugitive PM10	Exhaust PM10	PM10 Total	Fugitive PM2.5	Exhaust PM2.5	PM2.5 Total	Bio- CO2	NBio- CO2	Total CO2	CH4	N2O	CO2e
Category	tons/yr										MT/yr					
Hauling	0.0000	0.0000	0.0000	0.0000	0.0000	0.0000	0.0000	0.0000	0.0000	0.0000	0.0000	0.0000	0.0000	0.0000	0.0000	0.0000
Vendor	0.0848	3.3372	0.8133	0.0105	0.2689	3.9600e-003	0.2729	0.0777	3.7900e-003	0.0815	0.0000	1,012.4926	1,012.4926	0.0529	0.0000	1,013.8159
Worker	0.4590	0.2743	2.9493	9.2000e-003	1.0969	7.4800e-003	1.1044	0.2920	6.8900e-003	0.2989	0.0000	831.7436	831.7436	0.0201	0.0000	832.2470
<b>Total</b>	<b>0.5438</b>	<b>3.6115</b>	<b>3.7626</b>	<b>0.0197</b>	<b>1.3658</b>	<b>0.0114</b>	<b>1.3772</b>	<b>0.3697</b>	<b>0.0107</b>	<b>0.3804</b>	<b>0.0000</b>	<b>1,844.2361</b>	<b>1,844.2361</b>	<b>0.0731</b>	<b>0.0000</b>	<b>1,846.0629</b>

**3.5 Building Construction - 2026**

**Unmitigated Construction On-Site**

	ROG	NOx	CO	SO2	Fugitive PM10	Exhaust PM10	PM10 Total	Fugitive PM2.5	Exhaust PM2.5	PM2.5 Total	Bio- CO2	NBio- CO2	Total CO2	CH4	N2O	CO2e
Category	tons/yr										MT/yr					
Off-Road	0.1785	1.6273	2.0991	3.5200e-003		0.0689	0.0689		0.0648	0.0648	0.0000	302.6549	302.6549	0.0711	0.0000	304.4335
<b>Total</b>	<b>0.1785</b>	<b>1.6273</b>	<b>2.0991</b>	<b>3.5200e-003</b>		<b>0.0689</b>	<b>0.0689</b>		<b>0.0648</b>	<b>0.0648</b>	<b>0.0000</b>	<b>302.6549</b>	<b>302.6549</b>	<b>0.0711</b>	<b>0.0000</b>	<b>304.4335</b>

Rezoning Sites for Housing Project - Sonoma County - GHG Analysis - Sonoma-San Francisco County, Annual

**3.5 Building Construction - 2026**

**Unmitigated Construction Off-Site**

	ROG	NOx	CO	SO2	Fugitive PM10	Exhaust PM10	PM10 Total	Fugitive PM2.5	Exhaust PM2.5	PM2.5 Total	Bio- CO2	NBio- CO2	Total CO2	CH4	N2O	CO2e
Category	tons/yr										MT/yr					
Hauling	0.0000	0.0000	0.0000	0.0000	0.0000	0.0000	0.0000	0.0000	0.0000	0.0000	0.0000	0.0000	0.0000	0.0000	0.0000	0.0000
Vendor	0.0821	3.2926	0.7860	0.0104	0.2689	3.8000e-003	0.2727	0.0777	3.6300e-003	0.0814	0.0000	1,006.6931	1,006.6931	0.0523	0.0000	1,007.9992
Worker	0.4295	0.2485	2.7143	8.8400e-003	1.0969	7.2100e-003	1.1041	0.2920	6.6400e-003	0.2986	0.0000	799.8271	799.8271	0.0181	0.0000	800.2783
<b>Total</b>	<b>0.5116</b>	<b>3.5411</b>	<b>3.5003</b>	<b>0.0192</b>	<b>1.3658</b>	<b>0.0110</b>	<b>1.3768</b>	<b>0.3697</b>	<b>0.0103</b>	<b>0.3800</b>	<b>0.0000</b>	<b>1,806.5201</b>	<b>1,806.5201</b>	<b>0.0703</b>	<b>0.0000</b>	<b>1,808.2775</b>

**Mitigated Construction On-Site**

	ROG	NOx	CO	SO2	Fugitive PM10	Exhaust PM10	PM10 Total	Fugitive PM2.5	Exhaust PM2.5	PM2.5 Total	Bio- CO2	NBio- CO2	Total CO2	CH4	N2O	CO2e
Category	tons/yr										MT/yr					
Off-Road	0.1784	1.6273	2.0991	3.5200e-003		0.0689	0.0689		0.0648	0.0648	0.0000	302.6545	302.6545	0.0711	0.0000	304.4331
<b>Total</b>	<b>0.1784</b>	<b>1.6273</b>	<b>2.0991</b>	<b>3.5200e-003</b>		<b>0.0689</b>	<b>0.0689</b>		<b>0.0648</b>	<b>0.0648</b>	<b>0.0000</b>	<b>302.6545</b>	<b>302.6545</b>	<b>0.0711</b>	<b>0.0000</b>	<b>304.4331</b>

Rezoning Sites for Housing Project - Sonoma County - GHG Analysis - Sonoma-San Francisco County, Annual

**3.5 Building Construction - 2026**

**Mitigated Construction Off-Site**

	ROG	NOx	CO	SO2	Fugitive PM10	Exhaust PM10	PM10 Total	Fugitive PM2.5	Exhaust PM2.5	PM2.5 Total	Bio- CO2	NBio- CO2	Total CO2	CH4	N2O	CO2e
Category	tons/yr										MT/yr					
Hauling	0.0000	0.0000	0.0000	0.0000	0.0000	0.0000	0.0000	0.0000	0.0000	0.0000	0.0000	0.0000	0.0000	0.0000	0.0000	0.0000
Vendor	0.0821	3.2926	0.7860	0.0104	0.2689	3.8000e-003	0.2727	0.0777	3.6300e-003	0.0814	0.0000	1,006.6931	1,006.6931	0.0523	0.0000	1,007.9992
Worker	0.4295	0.2485	2.7143	8.8400e-003	1.0969	7.2100e-003	1.1041	0.2920	6.6400e-003	0.2986	0.0000	799.8271	799.8271	0.0181	0.0000	800.2783
<b>Total</b>	<b>0.5116</b>	<b>3.5411</b>	<b>3.5003</b>	<b>0.0192</b>	<b>1.3658</b>	<b>0.0110</b>	<b>1.3768</b>	<b>0.3697</b>	<b>0.0103</b>	<b>0.3800</b>	<b>0.0000</b>	<b>1,806.5201</b>	<b>1,806.5201</b>	<b>0.0703</b>	<b>0.0000</b>	<b>1,808.2775</b>

**3.5 Building Construction - 2027**

**Unmitigated Construction On-Site**

	ROG	NOx	CO	SO2	Fugitive PM10	Exhaust PM10	PM10 Total	Fugitive PM2.5	Exhaust PM2.5	PM2.5 Total	Bio- CO2	NBio- CO2	Total CO2	CH4	N2O	CO2e
Category	tons/yr										MT/yr					
Off-Road	0.1265	1.1535	1.4878	2.4900e-003		0.0488	0.0488		0.0459	0.0459	0.0000	214.5255	214.5255	0.0504	0.0000	215.7862
<b>Total</b>	<b>0.1265</b>	<b>1.1535</b>	<b>1.4878</b>	<b>2.4900e-003</b>		<b>0.0488</b>	<b>0.0488</b>		<b>0.0459</b>	<b>0.0459</b>	<b>0.0000</b>	<b>214.5255</b>	<b>214.5255</b>	<b>0.0504</b>	<b>0.0000</b>	<b>215.7862</b>

Rezoning Sites for Housing Project - Sonoma County - GHG Analysis - Sonoma-San Francisco County, Annual

**3.5 Building Construction - 2027**

**Unmitigated Construction Off-Site**

	ROG	NOx	CO	SO2	Fugitive PM10	Exhaust PM10	PM10 Total	Fugitive PM2.5	Exhaust PM2.5	PM2.5 Total	Bio- CO2	NBio- CO2	Total CO2	CH4	N2O	CO2e
Category	tons/yr										MT/yr					
Hauling	0.0000	0.0000	0.0000	0.0000	0.0000	0.0000	0.0000	0.0000	0.0000	0.0000	0.0000	0.0000	0.0000	0.0000	0.0000	0.0000
Vendor	0.0565	2.3035	0.5406	7.3100e-003	0.1906	2.6000e-003	0.1932	0.0551	2.4900e-003	0.0576	0.0000	709.6427	709.6427	0.0366	0.0000	710.5571
Worker	0.2841	0.1595	1.7739	6.0500e-003	0.7775	4.8100e-003	0.7823	0.2069	4.4300e-003	0.2114	0.0000	546.9450	546.9450	0.0115	0.0000	547.2319
<b>Total</b>	<b>0.3406</b>	<b>2.4630</b>	<b>2.3145</b>	<b>0.0134</b>	<b>0.9681</b>	<b>7.4100e-003</b>	<b>0.9755</b>	<b>0.2620</b>	<b>6.9200e-003</b>	<b>0.2689</b>	<b>0.0000</b>	<b>1,256.5877</b>	<b>1,256.5877</b>	<b>0.0481</b>	<b>0.0000</b>	<b>1,257.7890</b>

**Mitigated Construction On-Site**

	ROG	NOx	CO	SO2	Fugitive PM10	Exhaust PM10	PM10 Total	Fugitive PM2.5	Exhaust PM2.5	PM2.5 Total	Bio- CO2	NBio- CO2	Total CO2	CH4	N2O	CO2e
Category	tons/yr										MT/yr					
Off-Road	0.1265	1.1534	1.4878	2.4900e-003		0.0488	0.0488		0.0459	0.0459	0.0000	214.5252	214.5252	0.0504	0.0000	215.7860
<b>Total</b>	<b>0.1265</b>	<b>1.1534</b>	<b>1.4878</b>	<b>2.4900e-003</b>		<b>0.0488</b>	<b>0.0488</b>		<b>0.0459</b>	<b>0.0459</b>	<b>0.0000</b>	<b>214.5252</b>	<b>214.5252</b>	<b>0.0504</b>	<b>0.0000</b>	<b>215.7860</b>

Rezoning Sites for Housing Project - Sonoma County - GHG Analysis - Sonoma-San Francisco County, Annual

**3.5 Building Construction - 2027**

**Mitigated Construction Off-Site**

	ROG	NOx	CO	SO2	Fugitive PM10	Exhaust PM10	PM10 Total	Fugitive PM2.5	Exhaust PM2.5	PM2.5 Total	Bio- CO2	NBio- CO2	Total CO2	CH4	N2O	CO2e
Category	tons/yr										MT/yr					
Hauling	0.0000	0.0000	0.0000	0.0000	0.0000	0.0000	0.0000	0.0000	0.0000	0.0000	0.0000	0.0000	0.0000	0.0000	0.0000	0.0000
Vendor	0.0565	2.3035	0.5406	7.3100e-003	0.1906	2.6000e-003	0.1932	0.0551	2.4900e-003	0.0576	0.0000	709.6427	709.6427	0.0366	0.0000	710.5571
Worker	0.2841	0.1595	1.7739	6.0500e-003	0.7775	4.8100e-003	0.7823	0.2069	4.4300e-003	0.2114	0.0000	546.9450	546.9450	0.0115	0.0000	547.2319
<b>Total</b>	<b>0.3406</b>	<b>2.4630</b>	<b>2.3145</b>	<b>0.0134</b>	<b>0.9681</b>	<b>7.4100e-003</b>	<b>0.9755</b>	<b>0.2620</b>	<b>6.9200e-003</b>	<b>0.2689</b>	<b>0.0000</b>	<b>1,256.5877</b>	<b>1,256.5877</b>	<b>0.0481</b>	<b>0.0000</b>	<b>1,257.7890</b>

**3.6 Paving - 2027**

**Unmitigated Construction On-Site**

	ROG	NOx	CO	SO2	Fugitive PM10	Exhaust PM10	PM10 Total	Fugitive PM2.5	Exhaust PM2.5	PM2.5 Total	Bio- CO2	NBio- CO2	Total CO2	CH4	N2O	CO2e
Category	tons/yr										MT/yr					
Off-Road	0.0348	0.3261	0.5540	8.7000e-004		0.0159	0.0159		0.0146	0.0146	0.0000	76.0732	76.0732	0.0246	0.0000	76.6883
Paving	0.0000					0.0000	0.0000		0.0000	0.0000	0.0000	0.0000	0.0000	0.0000	0.0000	0.0000
<b>Total</b>	<b>0.0348</b>	<b>0.3261</b>	<b>0.5540</b>	<b>8.7000e-004</b>		<b>0.0159</b>	<b>0.0159</b>		<b>0.0146</b>	<b>0.0146</b>	<b>0.0000</b>	<b>76.0732</b>	<b>76.0732</b>	<b>0.0246</b>	<b>0.0000</b>	<b>76.6883</b>

Rezoning Sites for Housing Project - Sonoma County - GHG Analysis - Sonoma-San Francisco County, Annual

**3.6 Paving - 2027**

**Unmitigated Construction Off-Site**

	ROG	NOx	CO	SO2	Fugitive PM10	Exhaust PM10	PM10 Total	Fugitive PM2.5	Exhaust PM2.5	PM2.5 Total	Bio- CO2	NBio- CO2	Total CO2	CH4	N2O	CO2e
Category	tons/yr										MT/yr					
Hauling	0.0000	0.0000	0.0000	0.0000	0.0000	0.0000	0.0000	0.0000	0.0000	0.0000	0.0000	0.0000	0.0000	0.0000	0.0000	0.0000
Vendor	0.0000	0.0000	0.0000	0.0000	0.0000	0.0000	0.0000	0.0000	0.0000	0.0000	0.0000	0.0000	0.0000	0.0000	0.0000	0.0000
Worker	1.6300e-003	9.2000e-004	0.0102	3.0000e-005	4.4700e-003	3.0000e-005	4.5000e-003	1.1900e-003	3.0000e-005	1.2200e-003	0.0000	3.1469	3.1469	7.0000e-005	0.0000	3.1486
<b>Total</b>	<b>1.6300e-003</b>	<b>9.2000e-004</b>	<b>0.0102</b>	<b>3.0000e-005</b>	<b>4.4700e-003</b>	<b>3.0000e-005</b>	<b>4.5000e-003</b>	<b>1.1900e-003</b>	<b>3.0000e-005</b>	<b>1.2200e-003</b>	<b>0.0000</b>	<b>3.1469</b>	<b>3.1469</b>	<b>7.0000e-005</b>	<b>0.0000</b>	<b>3.1486</b>

**Mitigated Construction On-Site**

	ROG	NOx	CO	SO2	Fugitive PM10	Exhaust PM10	PM10 Total	Fugitive PM2.5	Exhaust PM2.5	PM2.5 Total	Bio- CO2	NBio- CO2	Total CO2	CH4	N2O	CO2e
Category	tons/yr										MT/yr					
Off-Road	0.0348	0.3261	0.5540	8.7000e-004		0.0159	0.0159		0.0146	0.0146	0.0000	76.0731	76.0731	0.0246	0.0000	76.6882
Paving	0.0000					0.0000	0.0000		0.0000	0.0000	0.0000	0.0000	0.0000	0.0000	0.0000	0.0000
<b>Total</b>	<b>0.0348</b>	<b>0.3261</b>	<b>0.5540</b>	<b>8.7000e-004</b>		<b>0.0159</b>	<b>0.0159</b>		<b>0.0146</b>	<b>0.0146</b>	<b>0.0000</b>	<b>76.0731</b>	<b>76.0731</b>	<b>0.0246</b>	<b>0.0000</b>	<b>76.6882</b>

Rezoning Sites for Housing Project - Sonoma County - GHG Analysis - Sonoma-San Francisco County, Annual

**3.6 Paving - 2027**

**Mitigated Construction Off-Site**

	ROG	NOx	CO	SO2	Fugitive PM10	Exhaust PM10	PM10 Total	Fugitive PM2.5	Exhaust PM2.5	PM2.5 Total	Bio- CO2	NBio- CO2	Total CO2	CH4	N2O	CO2e
Category	tons/yr										MT/yr					
Hauling	0.0000	0.0000	0.0000	0.0000	0.0000	0.0000	0.0000	0.0000	0.0000	0.0000	0.0000	0.0000	0.0000	0.0000	0.0000	0.0000
Vendor	0.0000	0.0000	0.0000	0.0000	0.0000	0.0000	0.0000	0.0000	0.0000	0.0000	0.0000	0.0000	0.0000	0.0000	0.0000	0.0000
Worker	1.6300e-003	9.2000e-004	0.0102	3.0000e-005	4.4700e-003	3.0000e-005	4.5000e-003	1.1900e-003	3.0000e-005	1.2200e-003	0.0000	3.1469	3.1469	7.0000e-005	0.0000	3.1486
<b>Total</b>	<b>1.6300e-003</b>	<b>9.2000e-004</b>	<b>0.0102</b>	<b>3.0000e-005</b>	<b>4.4700e-003</b>	<b>3.0000e-005</b>	<b>4.5000e-003</b>	<b>1.1900e-003</b>	<b>3.0000e-005</b>	<b>1.2200e-003</b>	<b>0.0000</b>	<b>3.1469</b>	<b>3.1469</b>	<b>7.0000e-005</b>	<b>0.0000</b>	<b>3.1486</b>

**3.6 Paving - 2028**

**Unmitigated Construction On-Site**

	ROG	NOx	CO	SO2	Fugitive PM10	Exhaust PM10	PM10 Total	Fugitive PM2.5	Exhaust PM2.5	PM2.5 Total	Bio- CO2	NBio- CO2	Total CO2	CH4	N2O	CO2e
Category	tons/yr										MT/yr					
Off-Road	0.1025	0.9611	1.6327	2.5500e-003		0.0469	0.0469		0.0431	0.0431	0.0000	224.2157	224.2157	0.0725	0.0000	226.0286
Paving	0.0000					0.0000	0.0000		0.0000	0.0000	0.0000	0.0000	0.0000	0.0000	0.0000	0.0000
<b>Total</b>	<b>0.1025</b>	<b>0.9611</b>	<b>1.6327</b>	<b>2.5500e-003</b>		<b>0.0469</b>	<b>0.0469</b>		<b>0.0431</b>	<b>0.0431</b>	<b>0.0000</b>	<b>224.2157</b>	<b>224.2157</b>	<b>0.0725</b>	<b>0.0000</b>	<b>226.0286</b>

Rezoning Sites for Housing Project - Sonoma County - GHG Analysis - Sonoma-San Francisco County, Annual

**3.6 Paving - 2028**

**Unmitigated Construction Off-Site**

	ROG	NOx	CO	SO2	Fugitive PM10	Exhaust PM10	PM10 Total	Fugitive PM2.5	Exhaust PM2.5	PM2.5 Total	Bio- CO2	NBio- CO2	Total CO2	CH4	N2O	CO2e
Category	tons/yr										MT/yr					
Hauling	0.0000	0.0000	0.0000	0.0000	0.0000	0.0000	0.0000	0.0000	0.0000	0.0000	0.0000	0.0000	0.0000	0.0000	0.0000	0.0000
Vendor	0.0000	0.0000	0.0000	0.0000	0.0000	0.0000	0.0000	0.0000	0.0000	0.0000	0.0000	0.0000	0.0000	0.0000	0.0000	0.0000
Worker	4.4700e-003	2.4500e-003	0.0279	1.0000e-004	0.0132	8.0000e-005	0.0133	3.5100e-003	7.0000e-005	3.5800e-003	0.0000	8.9753	8.9753	1.8000e-004	0.0000	8.9797
<b>Total</b>	<b>4.4700e-003</b>	<b>2.4500e-003</b>	<b>0.0279</b>	<b>1.0000e-004</b>	<b>0.0132</b>	<b>8.0000e-005</b>	<b>0.0133</b>	<b>3.5100e-003</b>	<b>7.0000e-005</b>	<b>3.5800e-003</b>	<b>0.0000</b>	<b>8.9753</b>	<b>8.9753</b>	<b>1.8000e-004</b>	<b>0.0000</b>	<b>8.9797</b>

**Mitigated Construction On-Site**

	ROG	NOx	CO	SO2	Fugitive PM10	Exhaust PM10	PM10 Total	Fugitive PM2.5	Exhaust PM2.5	PM2.5 Total	Bio- CO2	NBio- CO2	Total CO2	CH4	N2O	CO2e
Off-Road	0.1025	0.9611	1.6327	2.5500e-003		0.0469	0.0469		0.0431	0.0431	0.0000	224.2154	224.2154	0.0725	0.0000	226.0283
Paving	0.0000					0.0000	0.0000		0.0000	0.0000	0.0000	0.0000	0.0000	0.0000	0.0000	0.0000
<b>Total</b>	<b>0.1025</b>	<b>0.9611</b>	<b>1.6327</b>	<b>2.5500e-003</b>		<b>0.0469</b>	<b>0.0469</b>		<b>0.0431</b>	<b>0.0431</b>	<b>0.0000</b>	<b>224.2154</b>	<b>224.2154</b>	<b>0.0725</b>	<b>0.0000</b>	<b>226.0283</b>



Rezoning Sites for Housing Project - Sonoma County - GHG Analysis - Sonoma-San Francisco County, Annual

**3.6 Paving - 2028**

**Mitigated Construction Off-Site**

	ROG	NOx	CO	SO2	Fugitive PM10	Exhaust PM10	PM10 Total	Fugitive PM2.5	Exhaust PM2.5	PM2.5 Total	Bio- CO2	NBio- CO2	Total CO2	CH4	N2O	CO2e
Category	tons/yr										MT/yr					
Hauling	0.0000	0.0000	0.0000	0.0000	0.0000	0.0000	0.0000	0.0000	0.0000	0.0000	0.0000	0.0000	0.0000	0.0000	0.0000	0.0000
Vendor	0.0000	0.0000	0.0000	0.0000	0.0000	0.0000	0.0000	0.0000	0.0000	0.0000	0.0000	0.0000	0.0000	0.0000	0.0000	0.0000
Worker	4.4700e-003	2.4500e-003	0.0279	1.0000e-004	0.0132	8.0000e-005	0.0133	3.5100e-003	7.0000e-005	3.5800e-003	0.0000	8.9753	8.9753	1.8000e-004	0.0000	8.9797
<b>Total</b>	<b>4.4700e-003</b>	<b>2.4500e-003</b>	<b>0.0279</b>	<b>1.0000e-004</b>	<b>0.0132</b>	<b>8.0000e-005</b>	<b>0.0133</b>	<b>3.5100e-003</b>	<b>7.0000e-005</b>	<b>3.5800e-003</b>	<b>0.0000</b>	<b>8.9753</b>	<b>8.9753</b>	<b>1.8000e-004</b>	<b>0.0000</b>	<b>8.9797</b>

**3.7 Architectural Coating - 2028**

**Unmitigated Construction On-Site**

	ROG	NOx	CO	SO2	Fugitive PM10	Exhaust PM10	PM10 Total	Fugitive PM2.5	Exhaust PM2.5	PM2.5 Total	Bio- CO2	NBio- CO2	Total CO2	CH4	N2O	CO2e
Category	tons/yr										MT/yr					
Archit. Coating	4.5235					0.0000	0.0000		0.0000	0.0000	0.0000	0.0000	0.0000	0.0000	0.0000	0.0000
Off-Road	3.0800e-003	0.0206	0.0326	5.0000e-005		9.3000e-004	9.3000e-004		9.3000e-004	9.3000e-004	0.0000	4.5959	4.5959	2.5000e-004	0.0000	4.6021
<b>Total</b>	<b>4.5266</b>	<b>0.0206</b>	<b>0.0326</b>	<b>5.0000e-005</b>		<b>9.3000e-004</b>	<b>9.3000e-004</b>		<b>9.3000e-004</b>	<b>9.3000e-004</b>	<b>0.0000</b>	<b>4.5959</b>	<b>4.5959</b>	<b>2.5000e-004</b>	<b>0.0000</b>	<b>4.6021</b>

Rezoning Sites for Housing Project - Sonoma County - GHG Analysis - Sonoma-San Francisco County, Annual

**3.7 Architectural Coating - 2028**

**Unmitigated Construction Off-Site**

	ROG	NOx	CO	SO2	Fugitive PM10	Exhaust PM10	PM10 Total	Fugitive PM2.5	Exhaust PM2.5	PM2.5 Total	Bio- CO2	NBio- CO2	Total CO2	CH4	N2O	CO2e
Category	tons/yr										MT/yr					
Hauling	0.0000	0.0000	0.0000	0.0000	0.0000	0.0000	0.0000	0.0000	0.0000	0.0000	0.0000	0.0000	0.0000	0.0000	0.0000	0.0000
Vendor	0.0000	0.0000	0.0000	0.0000	0.0000	0.0000	0.0000	0.0000	0.0000	0.0000	0.0000	0.0000	0.0000	0.0000	0.0000	0.0000
Worker	0.0103	5.6200e-003	0.0640	2.3000e-004	0.0302	1.7000e-004	0.0304	8.0500e-003	1.6000e-004	8.2100e-003	0.0000	20.5790	20.5790	4.0000e-004	0.0000	20.5891
<b>Total</b>	<b>0.0103</b>	<b>5.6200e-003</b>	<b>0.0640</b>	<b>2.3000e-004</b>	<b>0.0302</b>	<b>1.7000e-004</b>	<b>0.0304</b>	<b>8.0500e-003</b>	<b>1.6000e-004</b>	<b>8.2100e-003</b>	<b>0.0000</b>	<b>20.5790</b>	<b>20.5790</b>	<b>4.0000e-004</b>	<b>0.0000</b>	<b>20.5891</b>

**Mitigated Construction On-Site**

	ROG	NOx	CO	SO2	Fugitive PM10	Exhaust PM10	PM10 Total	Fugitive PM2.5	Exhaust PM2.5	PM2.5 Total	Bio- CO2	NBio- CO2	Total CO2	CH4	N2O	CO2e
Category	tons/yr										MT/yr					
Archit. Coating	4.5235					0.0000	0.0000		0.0000	0.0000	0.0000	0.0000	0.0000	0.0000	0.0000	0.0000
Off-Road	3.0800e-003	0.0206	0.0326	5.0000e-005		9.3000e-004	9.3000e-004		9.3000e-004	9.3000e-004	0.0000	4.5959	4.5959	2.5000e-004	0.0000	4.6021
<b>Total</b>	<b>4.5266</b>	<b>0.0206</b>	<b>0.0326</b>	<b>5.0000e-005</b>		<b>9.3000e-004</b>	<b>9.3000e-004</b>		<b>9.3000e-004</b>	<b>9.3000e-004</b>	<b>0.0000</b>	<b>4.5959</b>	<b>4.5959</b>	<b>2.5000e-004</b>	<b>0.0000</b>	<b>4.6021</b>

Rezoning Sites for Housing Project - Sonoma County - GHG Analysis - Sonoma-San Francisco County, Annual

**3.7 Architectural Coating - 2028**

**Mitigated Construction Off-Site**

	ROG	NOx	CO	SO2	Fugitive PM10	Exhaust PM10	PM10 Total	Fugitive PM2.5	Exhaust PM2.5	PM2.5 Total	Bio- CO2	NBio- CO2	Total CO2	CH4	N2O	CO2e
Category	tons/yr										MT/yr					
Hauling	0.0000	0.0000	0.0000	0.0000	0.0000	0.0000	0.0000	0.0000	0.0000	0.0000	0.0000	0.0000	0.0000	0.0000	0.0000	0.0000
Vendor	0.0000	0.0000	0.0000	0.0000	0.0000	0.0000	0.0000	0.0000	0.0000	0.0000	0.0000	0.0000	0.0000	0.0000	0.0000	0.0000
Worker	0.0103	5.6200e-003	0.0640	2.3000e-004	0.0302	1.7000e-004	0.0304	8.0500e-003	1.6000e-004	8.2100e-003	0.0000	20.5790	20.5790	4.0000e-004	0.0000	20.5891
<b>Total</b>	<b>0.0103</b>	<b>5.6200e-003</b>	<b>0.0640</b>	<b>2.3000e-004</b>	<b>0.0302</b>	<b>1.7000e-004</b>	<b>0.0304</b>	<b>8.0500e-003</b>	<b>1.6000e-004</b>	<b>8.2100e-003</b>	<b>0.0000</b>	<b>20.5790</b>	<b>20.5790</b>	<b>4.0000e-004</b>	<b>0.0000</b>	<b>20.5891</b>

**3.7 Architectural Coating - 2029**

**Unmitigated Construction On-Site**

	ROG	NOx	CO	SO2	Fugitive PM10	Exhaust PM10	PM10 Total	Fugitive PM2.5	Exhaust PM2.5	PM2.5 Total	Bio- CO2	NBio- CO2	Total CO2	CH4	N2O	CO2e
Category	tons/yr										MT/yr					
Archit. Coating	32.7955					0.0000	0.0000		0.0000	0.0000	0.0000	0.0000	0.0000	0.0000	0.0000	0.0000
Off-Road	0.0223	0.1495	0.2361	3.9000e-004		6.7200e-003	6.7200e-003		6.7200e-003	6.7200e-003	0.0000	33.3200	33.3200	1.8200e-003	0.0000	33.3654
<b>Total</b>	<b>32.8178</b>	<b>0.1495</b>	<b>0.2361</b>	<b>3.9000e-004</b>		<b>6.7200e-003</b>	<b>6.7200e-003</b>		<b>6.7200e-003</b>	<b>6.7200e-003</b>	<b>0.0000</b>	<b>33.3200</b>	<b>33.3200</b>	<b>1.8200e-003</b>	<b>0.0000</b>	<b>33.3654</b>

Rezoning Sites for Housing Project - Sonoma County - GHG Analysis - Sonoma-San Francisco County, Annual

**3.7 Architectural Coating - 2029**

**Unmitigated Construction Off-Site**

Category	ROG	NOx	CO	SO2	Fugitive PM10	Exhaust PM10	PM10 Total	Fugitive PM2.5	Exhaust PM2.5	PM2.5 Total	Bio- CO2	NBio- CO2	Total CO2	CH4	N2O	CO2e
	tons/yr										MT/yr					
Hauling	0.0000	0.0000	0.0000	0.0000	0.0000	0.0000	0.0000	0.0000	0.0000	0.0000	0.0000	0.0000	0.0000	0.0000	0.0000	0.0000
Vendor	0.0000	0.0000	0.0000	0.0000	0.0000	0.0000	0.0000	0.0000	0.0000	0.0000	0.0000	0.0000	0.0000	0.0000	0.0000	0.0000
Worker	0.0683	0.0369	0.4291	1.6000e-003	0.2192	1.1700e-003	0.2203	0.0583	1.0700e-003	0.0594	0.0000	144.7873	144.7873	2.6300e-003	0.0000	144.8530
<b>Total</b>	<b>0.0683</b>	<b>0.0369</b>	<b>0.4291</b>	<b>1.6000e-003</b>	<b>0.2192</b>	<b>1.1700e-003</b>	<b>0.2203</b>	<b>0.0583</b>	<b>1.0700e-003</b>	<b>0.0594</b>	<b>0.0000</b>	<b>144.7873</b>	<b>144.7873</b>	<b>2.6300e-003</b>	<b>0.0000</b>	<b>144.8530</b>

**Mitigated Construction On-Site**

Category	ROG	NOx	CO	SO2	Fugitive PM10	Exhaust PM10	PM10 Total	Fugitive PM2.5	Exhaust PM2.5	PM2.5 Total	Bio- CO2	NBio- CO2	Total CO2	CH4	N2O	CO2e
	tons/yr										MT/yr					
Archit. Coating	32.7955					0.0000	0.0000		0.0000	0.0000	0.0000	0.0000	0.0000	0.0000	0.0000	0.0000
Off-Road	0.0223	0.1495	0.2361	3.9000e-004		6.7200e-003	6.7200e-003		6.7200e-003	6.7200e-003	0.0000	33.3199	33.3199	1.8200e-003	0.0000	33.3654
<b>Total</b>	<b>32.8178</b>	<b>0.1495</b>	<b>0.2361</b>	<b>3.9000e-004</b>		<b>6.7200e-003</b>	<b>6.7200e-003</b>		<b>6.7200e-003</b>	<b>6.7200e-003</b>	<b>0.0000</b>	<b>33.3199</b>	<b>33.3199</b>	<b>1.8200e-003</b>	<b>0.0000</b>	<b>33.3654</b>

Rezoning Sites for Housing Project - Sonoma County - GHG Analysis - Sonoma-San Francisco County, Annual

**3.7 Architectural Coating - 2029**

**Mitigated Construction Off-Site**

	ROG	NOx	CO	SO2	Fugitive PM10	Exhaust PM10	PM10 Total	Fugitive PM2.5	Exhaust PM2.5	PM2.5 Total	Bio- CO2	NBio- CO2	Total CO2	CH4	N2O	CO2e
Category	tons/yr										MT/yr					
Hauling	0.0000	0.0000	0.0000	0.0000	0.0000	0.0000	0.0000	0.0000	0.0000	0.0000	0.0000	0.0000	0.0000	0.0000	0.0000	0.0000
Vendor	0.0000	0.0000	0.0000	0.0000	0.0000	0.0000	0.0000	0.0000	0.0000	0.0000	0.0000	0.0000	0.0000	0.0000	0.0000	0.0000
Worker	0.0683	0.0369	0.4291	1.6000e-003	0.2192	1.1700e-003	0.2203	0.0583	1.0700e-003	0.0594	0.0000	144.7873	144.7873	2.6300e-003	0.0000	144.8530
<b>Total</b>	<b>0.0683</b>	<b>0.0369</b>	<b>0.4291</b>	<b>1.6000e-003</b>	<b>0.2192</b>	<b>1.1700e-003</b>	<b>0.2203</b>	<b>0.0583</b>	<b>1.0700e-003</b>	<b>0.0594</b>	<b>0.0000</b>	<b>144.7873</b>	<b>144.7873</b>	<b>2.6300e-003</b>	<b>0.0000</b>	<b>144.8530</b>

**3.7 Architectural Coating - 2030**

**Unmitigated Construction On-Site**

	ROG	NOx	CO	SO2	Fugitive PM10	Exhaust PM10	PM10 Total	Fugitive PM2.5	Exhaust PM2.5	PM2.5 Total	Bio- CO2	NBio- CO2	Total CO2	CH4	N2O	CO2e
Category	tons/yr										MT/yr					
Archit. Coating	0.3770					0.0000	0.0000		0.0000	0.0000	0.0000	0.0000	0.0000	0.0000	0.0000	0.0000
Off-Road	2.0000e-004	1.2800e-003	2.7000e-003	0.0000		3.0000e-005	3.0000e-005		3.0000e-005	3.0000e-005	0.0000	0.3830	0.3830	2.0000e-005	0.0000	0.3834
<b>Total</b>	<b>0.3772</b>	<b>1.2800e-003</b>	<b>2.7000e-003</b>	<b>0.0000</b>		<b>3.0000e-005</b>	<b>3.0000e-005</b>		<b>3.0000e-005</b>	<b>3.0000e-005</b>	<b>0.0000</b>	<b>0.3830</b>	<b>0.3830</b>	<b>2.0000e-005</b>	<b>0.0000</b>	<b>0.3834</b>

Rezoning Sites for Housing Project - Sonoma County - GHG Analysis - Sonoma-San Francisco County, Annual

**3.7 Architectural Coating - 2030**

**Unmitigated Construction Off-Site**

	ROG	NOx	CO	SO2	Fugitive PM10	Exhaust PM10	PM10 Total	Fugitive PM2.5	Exhaust PM2.5	PM2.5 Total	Bio- CO2	NBio- CO2	Total CO2	CH4	N2O	CO2e
Category	tons/yr										MT/yr					
Hauling	0.0000	0.0000	0.0000	0.0000	0.0000	0.0000	0.0000	0.0000	0.0000	0.0000	0.0000	0.0000	0.0000	0.0000	0.0000	0.0000
Vendor	0.0000	0.0000	0.0000	0.0000	0.0000	0.0000	0.0000	0.0000	0.0000	0.0000	0.0000	0.0000	0.0000	0.0000	0.0000	0.0000
Worker	7.2000e-004	3.8000e-004	4.5800e-003	2.0000e-005	2.5200e-003	1.0000e-005	2.5300e-003	6.7000e-004	1.0000e-005	6.8000e-004	0.0000	1.6196	1.6196	3.0000e-005	0.0000	1.6202
<b>Total</b>	<b>7.2000e-004</b>	<b>3.8000e-004</b>	<b>4.5800e-003</b>	<b>2.0000e-005</b>	<b>2.5200e-003</b>	<b>1.0000e-005</b>	<b>2.5300e-003</b>	<b>6.7000e-004</b>	<b>1.0000e-005</b>	<b>6.8000e-004</b>	<b>0.0000</b>	<b>1.6196</b>	<b>1.6196</b>	<b>3.0000e-005</b>	<b>0.0000</b>	<b>1.6202</b>

**Mitigated Construction On-Site**

	ROG	NOx	CO	SO2	Fugitive PM10	Exhaust PM10	PM10 Total	Fugitive PM2.5	Exhaust PM2.5	PM2.5 Total	Bio- CO2	NBio- CO2	Total CO2	CH4	N2O	CO2e
Category	tons/yr										MT/yr					
Archit. Coating	0.3770					0.0000	0.0000		0.0000	0.0000	0.0000	0.0000	0.0000	0.0000	0.0000	0.0000
Off-Road	2.0000e-004	1.2800e-003	2.7000e-003	0.0000		3.0000e-005	3.0000e-005		3.0000e-005	3.0000e-005	0.0000	0.3830	0.3830	2.0000e-005	0.0000	0.3834
<b>Total</b>	<b>0.3772</b>	<b>1.2800e-003</b>	<b>2.7000e-003</b>	<b>0.0000</b>		<b>3.0000e-005</b>	<b>3.0000e-005</b>		<b>3.0000e-005</b>	<b>3.0000e-005</b>	<b>0.0000</b>	<b>0.3830</b>	<b>0.3830</b>	<b>2.0000e-005</b>	<b>0.0000</b>	<b>0.3834</b>

Rezoning Sites for Housing Project - Sonoma County - GHG Analysis - Sonoma-San Francisco County, Annual

**3.7 Architectural Coating - 2030**

**Mitigated Construction Off-Site**

	ROG	NOx	CO	SO2	Fugitive PM10	Exhaust PM10	PM10 Total	Fugitive PM2.5	Exhaust PM2.5	PM2.5 Total	Bio- CO2	NBio- CO2	Total CO2	CH4	N2O	CO2e
Category	tons/yr										MT/yr					
Hauling	0.0000	0.0000	0.0000	0.0000	0.0000	0.0000	0.0000	0.0000	0.0000	0.0000	0.0000	0.0000	0.0000	0.0000	0.0000	0.0000
Vendor	0.0000	0.0000	0.0000	0.0000	0.0000	0.0000	0.0000	0.0000	0.0000	0.0000	0.0000	0.0000	0.0000	0.0000	0.0000	0.0000
Worker	7.2000e-004	3.8000e-004	4.5800e-003	2.0000e-005	2.5200e-003	1.0000e-005	2.5300e-003	6.7000e-004	1.0000e-005	6.8000e-004	0.0000	1.6196	1.6196	3.0000e-005	0.0000	1.6202
<b>Total</b>	<b>7.2000e-004</b>	<b>3.8000e-004</b>	<b>4.5800e-003</b>	<b>2.0000e-005</b>	<b>2.5200e-003</b>	<b>1.0000e-005</b>	<b>2.5300e-003</b>	<b>6.7000e-004</b>	<b>1.0000e-005</b>	<b>6.8000e-004</b>	<b>0.0000</b>	<b>1.6196</b>	<b>1.6196</b>	<b>3.0000e-005</b>	<b>0.0000</b>	<b>1.6202</b>

**4.0 Operational Detail - Mobile**

---

**4.1 Mitigation Measures Mobile**

Rezoning Sites for Housing Project - Sonoma County - GHG Analysis - Sonoma-San Francisco County, Annual

	ROG	NOx	CO	SO2	Fugitive PM10	Exhaust PM10	PM10 Total	Fugitive PM2.5	Exhaust PM2.5	PM2.5 Total	Bio- CO2	NBio- CO2	Total CO2	CH4	N2O	CO2e
Category	tons/yr										MT/yr					
Mitigated	4.9629	24.7554	55.1400	0.1614	12.6974	0.1687	12.8662	3.4172	0.1585	3.5757	0.0000	14,828.9345	14,828.9345	0.6650	0.0000	14,845.5600
Unmitigated	4.9629	24.7554	55.1400	0.1614	12.6974	0.1687	12.8662	3.4172	0.1585	3.5757	0.0000	14,828.9345	14,828.9345	0.6650	0.0000	14,845.5600

4.2 Trip Summary Information

Land Use	Average Daily Trip Rate			Unmitigated	Mitigated
	Weekday	Saturday	Sunday	Annual VMT	Annual VMT
Single Family Housing	14,815.50	14,815.50	14,815.50	34,217,987	34,217,987
Total	14,815.50	14,815.50	14,815.50	34,217,987	34,217,987

4.3 Trip Type Information

Land Use	Miles			Trip %			Trip Purpose %		
	H-W or C-W	H-S or C-C	H-O or C-NW	H-W or C-W	H-S or C-C	H-O or C-NW	Primary	Diverted	Pass-by
Single Family Housing	10.80	4.80	5.70	31.00	15.00	54.00	86	11	3

4.4 Fleet Mix

Land Use	LDA	LDT1	LDT2	MDV	LHD1	LHD2	MHD	HHD	OBUS	UBUS	MCY	SBUS	MH
Single Family Housing	0.578299	0.039453	0.169996	0.109068	0.028307	0.006716	0.029274	0.026666	0.003071	0.001838	0.005325	0.000874	0.001112

5.0 Energy Detail

Historical Energy Use: N



Rezoning Sites for Housing Project - Sonoma County - GHG Analysis - Sonoma-San Francisco County, Annual

**5.1 Mitigation Measures Energy**

Kilowatt Hours of Renewable Electricity Generated

	ROG	NOx	CO	SO2	Fugitive PM10	Exhaust PM10	PM10 Total	Fugitive PM2.5	Exhaust PM2.5	PM2.5 Total	Bio- CO2	NBio- CO2	Total CO2	CH4	N2O	CO2e
Category	tons/yr										MT/yr					
Electricity Mitigated						0.0000	0.0000		0.0000	0.0000	0.0000	3,601.2353	3,601.2353	0.1659	0.0377	3,616.6175
Electricity Unmitigated						0.0000	0.0000		0.0000	0.0000	0.0000	5,214.3016	5,214.3016	0.2402	0.0546	5,236.5738
NaturalGas Mitigated	0.4663	3.9843	1.6955	0.0254		0.3221	0.3221		0.3221	0.3221	0.0000	4,614.2961	4,614.2961	0.0884	0.0846	4,641.7165
NaturalGas Unmitigated	0.4663	3.9843	1.6955	0.0254		0.3221	0.3221		0.3221	0.3221	0.0000	4,614.2961	4,614.2961	0.0884	0.0846	4,641.7165

Rezoning Sites for Housing Project - Sonoma County - GHG Analysis - Sonoma-San Francisco County, Annual

**5.2 Energy by Land Use - NaturalGas**

**Unmitigated**

	NaturalGas Use	ROG	NOx	CO	SO2	Fugitive PM10	Exhaust PM10	PM10 Total	Fugitive PM2.5	Exhaust PM2.5	PM2.5 Total	Bio- CO2	NBio- CO2	Total CO2	CH4	N2O	CO2e
	kBTU/yr	tons/yr										MT/yr					
Single Family Housing	8.64686e+007	0.4663	3.9843	1.6955	0.0254		0.3221	0.3221		0.3221	0.3221	0.0000	4,614.2961	4,614.2961	0.0884	0.0846	4,641.7165
<b>Total</b>		<b>0.4663</b>	<b>3.9843</b>	<b>1.6955</b>	<b>0.0254</b>		<b>0.3221</b>	<b>0.3221</b>		<b>0.3221</b>	<b>0.3221</b>	<b>0.0000</b>	<b>4,614.2961</b>	<b>4,614.2961</b>	<b>0.0884</b>	<b>0.0846</b>	<b>4,641.7165</b>

**Mitigated**

	NaturalGas Use	ROG	NOx	CO	SO2	Fugitive PM10	Exhaust PM10	PM10 Total	Fugitive PM2.5	Exhaust PM2.5	PM2.5 Total	Bio- CO2	NBio- CO2	Total CO2	CH4	N2O	CO2e
Land Use	kBTU/yr	tons/yr										MT/yr					
Single Family Housing	8.64686e+007	0.4663	3.9843	1.6955	0.0254		0.3221	0.3221		0.3221	0.3221	0.0000	4,614.2961	4,614.2961	0.0884	0.0846	4,641.7165
<b>Total</b>		<b>0.4663</b>	<b>3.9843</b>	<b>1.6955</b>	<b>0.0254</b>		<b>0.3221</b>	<b>0.3221</b>		<b>0.3221</b>	<b>0.3221</b>	<b>0.0000</b>	<b>4,614.2961</b>	<b>4,614.2961</b>	<b>0.0884</b>	<b>0.0846</b>	<b>4,641.7165</b>

Rezoning Sites for Housing Project - Sonoma County - GHG Analysis - Sonoma-San Francisco County, Annual

**5.3 Energy by Land Use - Electricity**

**Unmitigated**

	Electricity Use	Total CO2	CH4	N2O	CO2e
Land Use	kWh/yr	MT/yr			
Single Family Housing	2.40694e+007	5,214.3016	0.2402	0.0546	5,236.5738
<b>Total</b>		<b>5,214.3016</b>	<b>0.2402</b>	<b>0.0546</b>	<b>5,236.5738</b>

**Mitigated**

	Electricity Use	Total CO2	CH4	N2O	CO2e
Land Use	kWh/yr	MT/yr			
Single Family Housing	1.66235e+007	3,601.2353	0.1659	0.0377	3,616.6175
<b>Total</b>		<b>3,601.2353</b>	<b>0.1659</b>	<b>0.0377</b>	<b>3,616.6175</b>

**6.0 Area Detail**

**6.1 Mitigation Measures Area**

Rezoning Sites for Housing Project - Sonoma County - GHG Analysis - Sonoma-San Francisco County, Annual

	ROG	NOx	CO	SO2	Fugitive PM10	Exhaust PM10	PM10 Total	Fugitive PM2.5	Exhaust PM2.5	PM2.5 Total	Bio- CO2	NBio- CO2	Total CO2	CH4	N2O	CO2e
Category	tons/yr										MT/yr					
Mitigated	42.8889	0.6398	47.6349	0.0537		3.7989	3.7989		3.7989	3.7989	378.1552	128.9324	507.0876	0.7495	0.0216	532.2658
Unmitigated	42.8889	0.6398	47.6349	0.0537		3.7989	3.7989		3.7989	3.7989	378.1552	128.9324	507.0876	0.7495	0.0216	532.2658

6.2 Area by SubCategory

Unmitigated

	ROG	NOx	CO	SO2	Fugitive PM10	Exhaust PM10	PM10 Total	Fugitive PM2.5	Exhaust PM2.5	PM2.5 Total	Bio- CO2	NBio- CO2	Total CO2	CH4	N2O	CO2e
SubCategory	tons/yr										MT/yr					
Architectural Coating	3.7696					0.0000	0.0000		0.0000	0.0000	0.0000	0.0000	0.0000	0.0000	0.0000	0.0000
Consumer Products	20.9140					0.0000	0.0000		0.0000	0.0000	0.0000	0.0000	0.0000	0.0000	0.0000	0.0000
Hearth	17.5346	0.3843	25.4972	0.0526		3.6769	3.6769		3.6769	3.6769	378.1552	92.8492	471.0044	0.7145	0.0216	495.3084
Landscaping	0.6707	0.2555	22.1377	1.1700e-003		0.1220	0.1220		0.1220	0.1220	0.0000	36.0832	36.0832	0.0350	0.0000	36.9574
<b>Total</b>	<b>42.8889</b>	<b>0.6398</b>	<b>47.6349</b>	<b>0.0537</b>		<b>3.7989</b>	<b>3.7989</b>		<b>3.7989</b>	<b>3.7989</b>	<b>378.1552</b>	<b>128.9324</b>	<b>507.0876</b>	<b>0.7495</b>	<b>0.0216</b>	<b>532.2658</b>

Rezoning Sites for Housing Project - Sonoma County - GHG Analysis - Sonoma-San Francisco County, Annual

**6.2 Area by SubCategory**

**Mitigated**

	ROG	NOx	CO	SO2	Fugitive PM10	Exhaust PM10	PM10 Total	Fugitive PM2.5	Exhaust PM2.5	PM2.5 Total	Bio- CO2	NBio- CO2	Total CO2	CH4	N2O	CO2e
SubCategory	tons/yr										MT/yr					
Architectural Coating	3.7696					0.0000	0.0000		0.0000	0.0000	0.0000	0.0000	0.0000	0.0000	0.0000	0.0000
Consumer Products	20.9140					0.0000	0.0000		0.0000	0.0000	0.0000	0.0000	0.0000	0.0000	0.0000	0.0000
Hearth	17.5346	0.3843	25.4972	0.0526		3.6769	3.6769		3.6769	3.6769	378.1552	92.8492	471.0044	0.7145	0.0216	495.3084
Landscaping	0.6707	0.2555	22.1377	1.1700e-003		0.1220	0.1220		0.1220	0.1220	0.0000	36.0832	36.0832	0.0350	0.0000	36.9574
<b>Total</b>	<b>42.8889</b>	<b>0.6398</b>	<b>47.6349</b>	<b>0.0537</b>		<b>3.7989</b>	<b>3.7989</b>		<b>3.7989</b>	<b>3.7989</b>	<b>378.1552</b>	<b>128.9324</b>	<b>507.0876</b>	<b>0.7495</b>	<b>0.0216</b>	<b>532.2658</b>

**7.0 Water Detail**

**7.1 Mitigation Measures Water**

Apply Water Conservation Strategy

Rezoning Sites for Housing Project - Sonoma County - GHG Analysis - Sonoma-San Francisco County, Annual

	Total CO2	CH4	N2O	CO2e
Category	MT/yr			
Mitigated	323.6215	5.0655	0.1222	486.6688
Unmitigated	381.3632	6.3308	0.1525	585.0734

**7.2 Water by Land Use**

**Unmitigated**

	Indoor/Outdoor Use	Total CO2	CH4	N2O	CO2e
Land Use	Mgal	MT/yr			
Single Family Housing	193.833 / 122.199	381.3632	6.3308	0.1525	585.0734
<b>Total</b>		<b>381.3632</b>	<b>6.3308</b>	<b>0.1525</b>	<b>585.0734</b>

Rezoning Sites for Housing Project - Sonoma County - GHG Analysis - Sonoma-San Francisco County, Annual

**7.2 Water by Land Use**

**Mitigated**

	Indoor/Outdoor Use	Total CO2	CH4	N2O	CO2e
Land Use	Mgal	MT/yr			
Single Family Housing	155.067 / 122.199	323.6215	5.0655	0.1222	486.6688
<b>Total</b>		<b>323.6215</b>	<b>5.0655</b>	<b>0.1222</b>	<b>486.6688</b>

**8.0 Waste Detail**

---

**8.1 Mitigation Measures Waste**

**Category/Year**

	Total CO2	CH4	N2O	CO2e
	MT/yr			
Mitigated	725.4450	42.8726	0.0000	1,797.2594
Unmitigated	725.4450	42.8726	0.0000	1,797.2594

Rezoning Sites for Housing Project - Sonoma County - GHG Analysis - Sonoma-San Francisco County, Annual

**8.2 Waste by Land Use**

**Unmitigated**

	Waste Disposed	Total CO2	CH4	N2O	CO2e
Land Use	tons	MT/yr			
Single Family Housing	3573.78	725.4450	42.8726	0.0000	1,797.2594
<b>Total</b>		<b>725.4450</b>	<b>42.8726</b>	<b>0.0000</b>	<b>1,797.2594</b>

**Mitigated**

	Waste Disposed	Total CO2	CH4	N2O	CO2e
Land Use	tons	MT/yr			
Single Family Housing	3573.78	725.4450	42.8726	0.0000	1,797.2594
<b>Total</b>		<b>725.4450</b>	<b>42.8726</b>	<b>0.0000</b>	<b>1,797.2594</b>

**9.0 Operational Offroad**

---

Equipment Type	Number	Hours/Day	Days/Year	Horse Power	Load Factor	Fuel Type
----------------	--------	-----------	-----------	-------------	-------------	-----------



## Rezoning Sites for Housing Project - Sonoma County - GHG Analysis - Sonoma-San Francisco County, Annual

**10.0 Stationary Equipment**

---

**Fire Pumps and Emergency Generators**

Equipment Type	Number	Hours/Day	Hours/Year	Horse Power	Load Factor	Fuel Type
----------------	--------	-----------	------------	-------------	-------------	-----------

**Boilers**

Equipment Type	Number	Heat Input/Day	Heat Input/Year	Boiler Rating	Fuel Type
----------------	--------	----------------	-----------------	---------------	-----------

**User Defined Equipment**

Equipment Type	Number
----------------	--------

**11.0 Vegetation**

---

# Appendix BIO

---

Biological Resources Assessment



## Housing Element Update

### Biological Resources Assessment

*prepared by*

**Sonoma County**

Permit Sonoma

2550 Ventura Avenue

Santa Rosa, California 95403

Contact: Nina Bellucci

*prepared with the assistance of*

**Rincon Consultants, Inc.**

4825 J Street, Suite 200

Sacramento, California 95819

**October 2022**

# Rezone Sites for Housing Project

## Biological Resources Assessment

*prepared by*

**Sonoma County**

Permit Sonoma

2550 Ventura Avenue

Santa Rosa, California 95403

Contact: Nina Bellucci

*prepared with the assistance of*

**Rincon Consultants, Inc.**

4825 J Street, Suite 200

Sacramento, California 95819

**October 2022**



**RINCON CONSULTANTS, INC.**

Environmental Scientists | Planners | Engineers

[rinconconsultants.com](http://rinconconsultants.com)

*This report prepared on 50% recycled paper with 50% post-consumer content.*

# Table of Contents

---

Executive Summary .....	1
1 Introduction .....	4
1.1 Project Location .....	4
1.2 Project Description.....	4
2 Methodology .....	8
2.1 Regulatory Overview.....	8
2.2 Biological Study Area .....	9
2.3 Literature Review .....	10
2.4 Desktop Mapping.....	11
3 Existing Conditions.....	12
3.1 Physical Characteristics.....	12
3.2 Vegetation and Other Land Cover .....	15
3.3 General Wildlife .....	23
4 Sensitive Biological Resources .....	25
4.1 Special Status Species .....	25
4.2 Sensitive Plant Communities and Critical Habitats .....	29
4.3 Jurisdictional Waters and Wetlands .....	32
4.4 Wildlife Movement .....	32
4.5 Resources Protected by Local Policies and Ordinances.....	33
4.6 Santa Rosa Plain Conservation Strategy .....	34
5 Impact Analysis and Mitigation Measures.....	35
5.1 Special-Status Species.....	36
5.2 Sensitive Plant Communities .....	43
5.3 Jurisdictional Waters and Wetlands .....	44
5.4 Wildlife Movement .....	46
5.5 Local Policies and Ordinances.....	46
5.6 Adopted or Approved Plans.....	47
6 Limitations, Assumptions, and Use Reliance .....	48
7 References .....	49
8 List of Preparers.....	52

## **Tables**

Table 1	Total Acreage of 11 Biological Study Areas.....	10
Table 2	Soil List for 11 Study Areas.....	13
Table 3	Vegetation Communities and Land Cover Types in the BSAs .....	16
Table 4	Federal and State-listed Plant Species with Potential to Occur in the BSA .....	26
Table 5	Special Status Plants Documented in the BSA .....	27
Table 6	Federal and State-listed Animals with Potential to Occur in the BSA .....	28
Table 7	BSA Distance (miles) from Eight Federally Designated Critical Habitats .....	30

## **Appendices**

Appendix A	Figures
Appendix B	Regulatory Framework
Appendix C	Special Status Species Evaluation Tables

# Executive Summary

---

The Sonoma County Housing Element Update (project) would update Sonoma County's current Housing Element, including goals, objectives, policies, and implementing programs. The project would rezone up to 59 Rezoning Sites located in designated Urban Service Areas throughout unincorporated Sonoma County. The locations of the Rezoning Sites include Geyserville, Guerneville, Forestville, Larkfield, Graton, Santa Rosa, Penngrove, Petaluma, Glen Ellen, Agua Caliente, and Sonoma. The proposed Rezoning Sites would be located within developed urban areas, surrounded by roads, commercial development, and residential neighborhoods.

The Biological Study Areas (BSAs) examined for this analysis include the minimum boundary of all 59 Rezoning Sites in each of the 11 Urban Service Areas. Following this report, Appendix A presents report figures, and Appendix B outlines the applicable regulatory framework used in this analysis.

Vegetation communities and land cover types within the BSAs were developed based on aerial imagery and information provided by the Sonoma County Water Agency; Sonoma County Agricultural Preservation and Open Space District; and the Sonoma County Vegetation Mapping and LiDAR Program (Sonoma County 2018). A total of 32 vegetation communities and land cover types were identified within the BSAs, ranging from wetlands and waters to grasslands and woodlands.

A total of 78 special status plant species have potential to occur within the BSAs (Appendix C). Those potentially occurring special status plants that are federally and/or State-listed as endangered or threatened, or those presumed present, are included below.



## Federally and/or State-Listed Plant Species Potentially Occurring in the Biological Study Areas

---

Sonoma alopecurus	<i>Alopecurus aequalis</i> var. <i>sonomensis</i>
Baker's manzanita	<i>Arctostaphylos bakeri</i> ssp. <i>bakeri</i>
Marin manzanita	<i>Arctostaphylos virgata</i>
Clara Hunt's milk-vetch	<i>Astragalus claranus</i>
Sonoma sunshine	<i>Blennosperma bakeri</i>
Pitkin Marsh paintbrush	<i>Castilleja uliginosa</i>
Mason's ceanothus	<i>Ceanothus masonii</i>
Holly-leaved ceanothus	<i>Ceanothus purpureus</i>
Pappose tarplant	<i>Centromadia parryi</i> ssp. <i>parryi</i>
Vine Hill clarkia	<i>Clarkia imbricata</i>
Baker's larkspur	<i>Delphinium bakeri</i>
Loch Lomond button-celery	<i>Eryngium constancei</i>
Boggs Lake hedge-hyssop	<i>Gratiola heterosepala</i>
Congested-headed hayfield tarplant	<i>Hemizonia congesta</i> ssp. <i>congesta</i>
Burke's goldfields	<i>Lasthenia burkei</i>
Contra Costa goldfields	<i>Lasthenia conjugens</i>
Mason's lilaeopsis	<i>Lilaeopsis masonii</i>
Pitkin Marsh lily	<i>Lilium pardalinum</i> ssp. <i>pitkinense</i>
Sebastopol meadowfoam	<i>Limnanthes vinculans</i>
few-flowered navarretia	<i>Navarretia leucocephala</i> ssp. <i>pauciflora</i>
Many-flowered navarretia	<i>Navarretia leucocephala</i> ssp. <i>plieantha</i>
Geysers panicum	<i>Panicum acuminatum</i> var. <i>thermale</i>
North Coast semaphore grass	<i>Pleuropogon hooverianus</i>
Kenwood Marsh checkerbloom	<i>Sidalcea oregana</i> ssp. <i>valida</i>
Two-fork clover	<i>Trifolium amoenum</i>
Pacific Grove clover	<i>Trifolium polyodon</i>

---

A total of 39 special status animal species have some potential to occur in the BSAs, including 12 federal- or state-listed species. The federal and state listed species with potential to occur are presented below.

## Federally and/or State-listed Animal Species Potentially Occurring in the Biological Study Areas

Crotch bumble bee	<i>Bombus crotchii</i>
Western bumble bee	<i>Bombus occidentalis</i>
vernal pool fairy shrimp	<i>Branchinecta lynchi</i>
California freshwater shrimp	<i>Syncaris pacifica</i>
Coho salmon - central California coast ESU	<i>Oncorhynchus kisutch</i> pop. 4
Steelhead – central California DPS	<i>Oncorhynchus mykiss irideus</i> pop. 8
California tiger salamander- Sonoma County DPS	<i>Ambystoma californiense</i> pop. 3
California red-legged frog	<i>Rana draytonii</i>
Foothill yellow-legged frog – north coast DPS	<i>Rana boylei</i> pop.1
Tricolored blackbird	<i>Agelaius tricolor</i>
Swainson’s hawk	<i>Buteo swainsoni</i>
Northern spotted owl	<i>Strix occidentalis cauring</i>

The following five sensitive natural communities are known to occur within five miles of the BSAs:

- Northern Vernal Pool
- Coastal and Valley Freshwater Marsh
- Northern Hardpan Vernal Pool
- Valley Needlegrass Grassland
- Coastal Brackish Marsh

No sensitive natural communities were mapped within the BSAs; however, the vegetation communities mapped within the Santa Rosa and Penngrove BSAs include the Western North America Vernal Pool, which may be considered sensitive. Additionally, many of the specific vegetation alliances occurring within the BSAs may be considered sensitive under the revised ranking methodology prepared by the California Department of Fish and Wildlife (CDFW) (CDFW 2022c).

The project could impact special status plant and wildlife species if these species are present at the time of construction. Additionally, the project could impact potential jurisdictional waters of the U.S. and State. Measures to avoid, minimize, and mitigate potential impacts have been developed for all potential impacts.

# 1 Introduction

---

Rincon Consultants, Inc. (Rincon) has prepared this Biological Resources Assessment (BRA) to document existing conditions, summarize previous biological resource reports and studies, and provide a basis for evaluation of potential impacts to special status and sensitive biological resources from the implementation of the Sonoma County Housing Element Update (project) located in Sonoma County, California (Appendix A, Figure 1). This BRA has been prepared in support of California Environmental Quality Act (CEQA) review of the project. The lead agency for the project is Sonoma County.

## 1.1 Project Location

The proposed project encompasses all of Sonoma County and includes 79 total sites identified in the Housing Element site inventory (Appendix A, Figure 2). Of these 79 sites, there are 59 Rezoning Sites in the urban areas of unincorporated Sonoma County that are viable for rezoning to accommodate new housing. Specifically, the 59 Rezoning Sites are located in designated Urban Service Areas throughout Geyserville, Guerneville, Forestville, Larkfield, Graton, Santa Rosa, Penngrove, Petaluma, Glen Ellen, Agua Caliente, and Sonoma. The Rezoning Sites would be located within developed urban area, surrounded by roads, commercial developments, and residential neighborhoods.

## 1.2 Project Description

The project would update the County's current Housing Element, including goals, objectives, policies, and implementing programs to further the goal of meeting the existing and projected housing needs of all household income levels of the county. Physical changes resulting from project implementation may involve construction of housing on up to 59 Rezoning Sites scattered between 11 Urban Service Areas throughout Sonoma County. Current land use designations for the Rezoning Sites include agricultural, residential, commercial, and industrial uses.

The project would involve rezoning of urban sites for by-right medium-density housing. The project's new housing sites would facilitate compliance with Sonoma County's Regional Housing Needs Assessment (RHNA) allocation for the 2023-2031 planning period (6<sup>th</sup> RHNA cycle). The project would be consistent with current General Plan Policies and Programs, including Policy HE-2f to consider a variety of sites for higher-density and affordable housing, and Housing Element Programs 11 and 20, which encourage the identification of urban sites near jobs and transit that could accommodate additional housing. Overall, the proposed project includes (1) an update to the Sonoma County Housing Element; (2) a General Plan Map amendment as necessary and, where applicable, area plan amendments to change land uses and densities on identified sites; and, (3) rezoning of up to 59 sites to match new General Plan land uses or densities and/or to add the WH (Workforce Housing) Combining District. The analysis contained herein will focus on the 59 sites that will be rezoned, as other Housing Inventory Sites would not change from their baseline condition.

A description of the Urban Service Areas containing the Rezoning Sites is provided below. The BSAs evaluated for this analysis include the minimum bounding rectangle for all Rezoning Sites in each of the 11 Urban Service Areas, along with a 500-foot buffer to encompass potential impacts to biological resources.

## Geyserville

The Geyserville Urban Service Area (GEY), located in northern Sonoma County, in northern Geyserville, contains four Rezoning Sites: GEY-1, GEY-2, GEY-3, GEY-4. The sites are situated between Highway 101 to the south, Geyserville Avenue to the north, Canyon Road to the west, and urban development to the east. The Rezoning Sites within the BSA are comprised of a fallow field and rural residential areas. Fallow agricultural land is also located north of the BSA. Wood Creek runs through the BSA, between the Rezoning Sites.

## Guerneville

The Guerneville Urban Service Area (GUE) is located in Guerneville between Armstrong Redwoods State National Reserve and the Sonoma Coast State Park. Four Rezoning Sites are envisioned for this service area (GUE-1, GUE-2, GUE-3, GUE-4). The BSA is located within urban development, with woodland habitat to the north and east, the Russian River approximately 300 feet to the south, and fallow agricultural land surrounded by woodland habitat to the west. Fife Creek runs through the southeast portion of the BSA. The Rezoning Sites within the BSA are comprised of rural residential areas and undeveloped land.

## Forestville

The Forestville Urban Service Area (FOR) is located in central Sonoma County and contains six Rezoning Sites (FOR-1, FOR-2, FOR-3, FOR-4, FOR-5, FOR-6). The BSA is situated in urban development interspersed with woodland habitat. Urban development, including roads, commercial development, and residential homes, is located to the north and east, fallow agricultural lands are located to the south, and woodland habitat is located to the west of the BSA. Green Valley Creek runs through the buffer zone on the southeast side of the BSA. A freshwater pond is located in the buffer zone to the south. The Rezoning Sites within the BSA are comprised of rural residential areas and undeveloped land.

## Larkfield

The Larkfield Urban Service Area (LAR), located in central Sonoma County, includes eight Rezoning Sites (LAR-1, LAR-2, LAR-3, LAR-4, LAR-5, LAR-6, LAR-7, LAR-8). The BSA is situated in urban development. All Rezoning Sites are surrounded by urban development, including roads, commercial development, and residential homes. Mark West Creek runs through the southern portion of the BSA's buffer zone. The Rezoning Sites within the BSA are comprised of developed areas, fallow agricultural fields, and undeveloped land.

## Graton

The Graton Urban Service Area (GRA), located in central Sonoma County, in northeastern Graton, includes five Rezoning Sites (GRA-1, GRA-2, GRA-3, GRA-4, GRA-5). The BSA is situated in an urban setting; all but one site would be surrounded by urban development. The Rezoning Site on the northwest portion of the BSA is situated in riparian habitat, adjacent to Atascadero Creek. Atascadero Creek runs through the BSA's buffer zone on the western portion of the BSA. The western portion of the BSA contains riparian habitat, and the southeastern portion contains lands historically used for agricultural purposes that have since become overgrown with vegetation.

## **Santa Rosa**

The Santa Rosa Urban Service Area (SAN), located south of the City of Santa Rosa, contains ten Rezoning Sites (SAN-1, SAN-2, SAN-3, SAN-4, SAN-5, SAN-6, SAN-7, SAN-8, SAN-9, SAN-10). The BSA is situated in an urbanized area, and all rezone sites would be surrounded by urban development, including roads, commercial development, and residential homes. Highway 101 bisects the BSA. The Rezoning Sites within the BSA are comprised of developed areas, fallow agricultural fields, and undeveloped land.

## **Penngrove**

The Penngrove Urban Service Area (PEN), located between the cities of Santa Rosa and Petaluma in southern Sonoma County, includes nine rezone sites (PEN-1, PEN-2, PEN-3, PEN-4, PEN-5, PEN-6, PEN-7, PEN-8, PEN-9). The BSA is situated in an urbanized area, and all Rezoning Sites are surrounded by urban development, including roads, commercial development, and residential homes. Open, fallow agricultural land is located east of the BSA. Lichau Creek runs through the center/eastern portion of the BSA, connecting to the Petaluma River to the south. The Rezoning Sites within the BSA are comprised of developed and rural residential areas, and undeveloped land.

## **Petaluma**

The Petaluma Urban Service Area (PET) is located adjacent to the City of Petaluma in southern Sonoma County and includes four Rezoning Sites (PET-1, PET-2, PET-3, PET-4). The rezone sites would be situated together and surrounded by urban development, with Bodega Ave to the north, commercial and residential developments to the east, Western Ave to the south, and Cleveland Lane to the west. The southern portion of the BSA's buffer zone contains open, fallow agricultural land. The Rezoning Sites within the BSA are comprised of rural residential areas and undeveloped land.

## **Glen Ellen**

The Glen Ellen Urban Service Area (GLE) is located in southeastern Sonoma County, situated between Jack London State Historic Park and Sonoma Valley Regional Park. This service area proposes two rezone sites (GLE-1 and GLE-2). The Rezoning Sites would be surrounded by urban development, including Arnold Drive to the west, commercial and residential developments to the north and east, and Carquinez Avenue to the south. Calabazas Creek runs through the western portion of the BSA's buffer zone, where it meets with the Sonoma Creek and continues through the southern portion of the buffer zone. Trees are interspersed throughout the BSA. Sonoma Valley Regional Park is located approximately 0.25 mile northeast of the BSA and includes Suttonfield Lake, located approximately 0.6 mile northeast of the BSA.

## **Agua Caliente**

The Agua Caliente Urban Service Area (AGU) is located in southeastern Sonoma County, north of the City of Sonoma and proposes three rezone sites (AGU-1, AGU-2, AGU-3). Sonoma Creek and Agua Caliente Creek are located within the BSA on the eastern portion of the site. One of the Rezoning Sites is located in the stream. The remaining Rezoning Sites are located in rural residential areas and undeveloped land. The northern, western, and southern portion of the BSA contains urban development, including roads, commercial development, and residential homes.

## **Sonoma**

The Sonoma Urban Service Area (SON) is located on the southern border of the City of Sonoma in southeastern Sonoma County. The study area includes four Rezoning Sites (SON-1, SON-2, SON-3, SON-4). The proposed sites would be located in a developed area, and surrounded by urban development, including Leveroni Road to the north, Broadway to the east, and commercial and residential developments to the south and to the west. The Rezoning Sites within the BSA are comprised of rural residential and developed areas.

## 2 Methodology

---

### 2.1 Regulatory Overview

Regulated or sensitive resources studied and analyzed herein include special status plant and animal species, nesting birds and raptors, sensitive plant communities, jurisdictional waters and wetlands, wildlife movement, and locally protected resources, such as protected trees. Regulatory authority over biological resources is shared by Federal, State, and local authorities. Primary authority for regulation of general biological resources lies within the land use control and planning authority of local jurisdictions.

#### Definition of Special Status Species

For the purposes of this report, special status species include:

- Species listed as threatened or endangered under the Federal Endangered Species Act (FESA); species that are under review may be included if there is a reasonable expectation of listing within the life of the project
- Species listed as candidate, threatened, or endangered under the California Endangered Species Act (CESA)
- Species designated as Fully Protected, Species of Special Concern, or Watch List by the California Department of Fish and Wildlife (CDFW)
- Species designated as locally important by the Local Agency and/or otherwise protected through ordinance or local policy.
- Species designated with a California Rare Plant Rank (CRPR) of 1B or 2B.

#### Environmental Statutes

In this report, potential impacts to biological resources were analyzed based on the following statutes (Appendix B):

1. California Environmental Quality Act (CEQA)
2. Federal Endangered Species Act (ESA)
3. California Endangered Species Act (CESA)
4. Federal Clean Water Act (CWA)
5. California Fish and Game Code (CFGF) Section 3503
6. Migratory Bird Treaty Act (MBTA)
7. The Bald and Golden Eagle Protection Act
8. Porter-Cologne Water Quality Control Act
9. Santa Rosa Plain Conservation Strategy Area
10. Sonoma County Zoning Code
11. Sonoma County General Plan 2020 (2008, as amended 2016)

## Jurisdictional Water Regulations

Drainage ditches, seasonal wetlands, ephemeral and perennial streams, and seasonally flooded constructed basins in the Study Areas may be jurisdictional waters of the U.S. under CWA Sections 404 and 401, subject to U.S. Army Corps of Engineers (USACE) and Regional Water Quality Control Board (RWQCB) jurisdictions. In addition, the aquatic resources have defined beds, banks, and/or riparian habitats that are potentially under CDFW jurisdiction. Note the final jurisdictional determinations of the boundaries of waters, and riparian habitats, are made by each agency, typically at the time that authorizations to impact such features are requested.

## Guidelines for Determining CEQA Significance

The following threshold criteria, as defined by the CEQA Guidelines Appendix G Initial Study Checklist, were used to evaluate potential environmental effects. Based on these criteria, the project would have a significant effect on biological resources if it would:

- a) *Have substantial adverse effects, either directly or through habitat modifications, on any species identified as a candidate, sensitive or special status species in local or regional plans, policies, or regulations, or by the California Department of Fish and Wildlife or U.S. Fish and Wildlife Service*
- b) *Have a substantial adverse effect on any riparian habitat or other sensitive natural community identified in local or regional plans, policies, and regulations or by the California Department of Fish and Wildlife or U.S. Fish and Wildlife Service*
- c) *Have a substantial adverse effect on state or federally protected wetlands (including, but not limited to, marsh, vernal pool, coastal, etc.) through direct removal, filling, hydrological interruption, or other means*
- d) *Interfere substantially with the movement of any native resident or migratory fish or wildlife species or with established native resident or migratory wildlife corridors or impede the use of native wildlife nursery sites*
- e) *Conflict with any local policies or ordinances protecting biological resources, such as a tree preservation policy or ordinance*
- f) *Conflict with the provisions of an adopted Habitat Conservation Plan, Natural Community Conservation Plan, or other approved local, regional, or state habitat conservation plan*

## 2.2 Biological Study Area

The BSAs evaluated for this analysis includes the minimum bounding rectangle for all rezone sites in each of the 11 Urban Service Areas plus a 500-foot buffer to encompass potential impacts to biological resources (Appendix A, Figure 2). A summary of the total acreage of each BSA is presented below in Table 1.



**Table 1 Total Acreage of 11 Biological Study Areas**

BSA	Total Acreage
Geyserville	129.4
Guerneville	367.6
Forestville	459.9
Larkfield	212.4
Graton	368.3
Santa Rosa	829.1
Penngrove	306.1
Petaluma	60.8
Glen Ellen	30.1
Agua Caliente	156.6
Sonoma	41.2

## 2.3 Literature Review

Rincon conducted a literature review to characterize the nature and extent of biological resources on and adjacent to each BSA. The literature review included an evaluation of current and historical aerial photographs of the site (Google Earth 2022, regional and site-specific topographic maps, climatic data, and other available background information.

Queries of the U.S. Fish and Wildlife Service (USFWS) Information for Planning and Consultation system (IPaC; USFWS 2020a), CDFW California Natural Diversity Database (CNDDDB; 2022a), and California Native Plant Society (CNPS) online Inventory of Rare and Endangered Plants of California (2022) were conducted to obtain comprehensive information regarding State- and federally-listed species, and other special status species, considered to have potential to occur within the regional vicinity of the Sonoma County BSAs. The results of database queries and lists of special status species were reviewed by Rincon’s regional biological experts for accuracy and completeness. The final list of special status biological resources to be evaluated is the result of documented occurrences in the countywide search area for IPaC, in each BSA topographic quadrangle (quad) and eight surrounding quads for CNDDDB and the CNPS online Inventory, and species known to occur in the region based on biologists’ expert opinions. The results of the species potential-to-occur assessment, including a list of the quads used for database queries, were compiled into a table presented as Appendix C.

Additionally, the vegetation community characterizations for this analysis were based on the classification systems presented in the *United States National Vegetation Classification* (USNVC) and *A Manual of California Vegetation, Second Edition* (Sawyer et al. 2009). The potential for wildlife movement corridors was evaluated based on the California Essential Habitat Connectivity Project commissioned by the California Department of Transportation and CDFW (Spencer et al. 2010).

The following resources were reviewed for additional information on existing conditions relating to biological resources within the BSA:

1. United States Department of Agriculture (USDA), Natural Resources Conservation Service (NRCS) Web Soil Survey (2019a)
2. USFWS Critical Habitat Portal (2022a)

3. CDFW Biogeographic Information and Observation System (CDFW 2022b)
4. CDFW Special Vascular Plants, Bryophytes, and Lichens List (2022c)
5. CDFW Special Animals List (2022)

## 2.4 Desktop Mapping

Rincon developed detailed vegetation community and land-cover-type maps based on a review of aerial imagery and existing data on mapped vegetation communities in each of the 11 study areas, including information provided by the Sonoma County Water Agency, Sonoma County Agricultural Preservation and Open Space District, Sonoma County Vegetation Mapping and LiDAR Program (Sonoma County 2018). The purpose of the preliminary desktop mapping was to identify approximate boundaries of vegetation communities and make preliminary assessments of areas likely to support sensitive biological resources.

## 3 Existing Conditions

---

### 3.1 Physical Characteristics

Elevations in the BSAs range from approximately 40 to 400 feet (12.2 to 121.9 meters) above mean sea level. The climate in this region is generally mild with an annual minimum average temperature of 45.25 degrees Fahrenheit, a maximum temperature of 72.67 degrees Fahrenheit, and an annual total precipitation average of 31.43 inches (National Oceanic and Atmospheric Administration 2022). Urban development and agricultural land uses surround the BSAs. The Larkfield, Graton, Forestville, Santa Rosa, Penngrove, Petaluma, Agua Caliente, and Sonoma BSAs are located on the Sonoma valley floor in central/southern Sonoma County. Additionally, the Geyserville BSA is located on the Sonoma valley floor in northern Sonoma County. The Guerneville and Glen Ellen BSAs are in urban development, but in mountains with interspersed woodland habitats throughout and surrounding the BSA.

#### **Watershed and Drainages**

Seven creeks are located in the BSAs: Sonoma Creek, Atascadero Creek, and Mark West Creek, Lichau Creek, Fife Creek, Sonoma Creek, and Calabazas Creek (U.S. Geologic Survey 2020; USFWS 2020c). The Sonoma Creek sub-watershed is part of the San Pablo watershed and the Atascadero Creek sub-watershed is part of the Russian River watershed. The BSA are located within seven sub-watersheds as follows:

##### *Lower Sonoma Creek*

Agua Caliente creek connects to Sonoma Creek on the east side of the Agua Caliente BSA.

##### *Atascadero Creek*

Atascadero Creek crosses the western portion of Graton BSA.

##### *Mark West Creek*

Mark West Creek crosses the southwest corner of the Larkfield BSA.

##### *Lichau Creek*

Lichau Creek runs from the northwest corner of the Penngrove BSA down through the south east corner.

##### *Fife Creek*

Fife Creek runs from the northwest corner of the Guerneville BSA down through the south east corner, and into the Russian River.

##### *Calabazas Creek*

The confluence of Sonoma Creek and Calabazas Creek occurs along the west side of the Glen Ellen BSA.

## Fryer Creek

Fryer Creek crosses the southwest corner of the Sonoma BSA.

### Soils

Based on the most recent NRSC soil survey for Sonoma County (USDA, NRCS 2019a), the 11 study areas contain 48 soil map units (70 total, Table 2). Some of these soils are associated with rare plants, such as serpentine and alkaline soils. However, the Rezoning Sites would be in urban and semi-rural areas, surrounded by a degree of development. These developed areas occur primarily on fill and non-native soils. Of the 48 soil types, 8 soil types primarily make up the predominant soils of the BSA:

1. Zamora silty clay loam, moist, 0 to 2 percent slopes, MLRA 14
2. Spreckels loam, 2 to 9 percent slopes
3. Goldridge fine sandy loam, 2 to 9 percent slopes
4. Arbuckle gravelly loam, 0 to 5 percent slopes
5. Hugo very gravelly loam, 50 to 75 percent slopes
6. Yolo loam, 0 to 10 percent slopes, moist, MLRA 14
7. Wright loam, shallow, wet, 0 to 2 percent slopes

The Santa Rosa BSA contains eight soils on the National Hydric Soils List (USDA, NRCS 2019b) (Table 2). While these soils can occur in wetlands under certain conditions, including the presence of surface or groundwater, and feature hydrophytic plants, they may also be located in upland areas.

**Table 2 Soil List for 11 Study Areas**

Map Unit Symbol	Map Unit Name	Hydric Soil
<b>Geyserville</b>		
AkB	Arbuckle gravelly loam, 0 to 5 percent slopes	No
JoF	Josephine loam, 30 to 50 percent slopes	No
LmG	Los Gatos gravelly loam, 30 to 75 percent slopes	No
StF	Suther loam, 30 to 50 percent slopes	No
YnA	Yolo loam, 0 to 10 percent slopes, moist, MLRA 14	Yes
YrB	Yolo gravelly loam, 0 to 8 percent slopes, MLRA 14	Yes
<b>Guerneville</b>		
CrA	Cortina very gravelly sandy loam, 0 to 2 percent slopes	No
HKF	Hugo very gravelly loam, 30 to 50 percent slopes	No
HKG	Hugo very gravelly loam, 50 to 75 percent slopes	No
YmB	Yolo sandy loam, overwash, 0 to 5 percent slopes	No
YsA	Yolo silt loam, 0 to 5 percent slopes, MLRA 14	No
<b>Forestville</b>		
BcA	Bulcher fine sandy loam, overwash, 0 to 2 percent slopes	Yes
GdC	Goldridge fine sandy loam, 2 to 9 percent slopes	No
GdD	Goldridge fine sandy loam, 9 to 15 percent slopes, eroded	No
GdD2	Hugo very gravelly loam, 50 to 75 percent slopes	No

Sonoma County  
**Rezone Sites for Housing Project**

Map Unit Symbol	Map Unit Name	Hydric Soil
HnG	Hugo-Josephine complex, 50 to 75 percent slopes	No
JoE	Josephine loam, 9 to 30 percent slopes	No
LgF	Laughlin loam, 30 to 50 percent slopes	No
<b>Larkfield</b>		
CeA	Clear Lake clay, sandy substratum, drained, 0 to 2 percent slopes, MLRA 14	Yes
HcC	Haire clay loam, 0 to 9 percent slopes	No
HuB	Huichica loam, ponded, 0 to 5 percent slopes	Yes
YnA	Yolo loam, 0 to 10 percent slopes, moist, MLRA 14	No
YsA	Yolo silt loam, 0 to 5 percent slopes, MLRA 14	No
YtA	Yolo clay loam, 0 to 5 percent slopes, MLRA 14	No
<b>Graton</b>		
BcA	Blucher fine sandy loam, overwash, 0 to 2 percent slopes	Yes
BhB	Bulcher loam, 2 to 5 percent slopes	No
GdC	Goldridge fine sandy loam, 2 to 9 percent slopes	No
GdD	Goldridge fine sandy loam, 9 to 15 percent slopes	No
GdE	Goldridge fine sandy loam, 15 to 30 percent slopes	No
SbD	Sebastopol sandy loam, 9 to 15 percent slopes	No
SbE	Sebastopol sandy loam, 15 to 30 percent slopes	No
<b>Santa Rosa</b>		
CcA	Clear Lake clay loam, 0 to 2 percent slopes	Yes
CcB	Clear Lake clay loam, 2 to 5 percent slopes	Yes
CeA	Clear Lake clay, sandy substratum, drained, 0 to 2 percent slopes, MLRA 14	Yes
CeB	Clear Lake clay, drained, 2 to 5 percent slopes, MLRA 14	Yes
CfA	Clear Lake clay, ponded, 0 to 2 percent slopes	Yes
WgC	Wright loam, 0 to 9 percent slopes	Yes
WhA	Wright loam, wet, 0 to 2 percent slopes	Yes
WoA	Wright loam, shallow wet, 0 to 2 percent slopes	Yes
<b>Penngrove</b>		
CeA	Clear Lake clay, sandy substratum, drained, 0 to 2 percent slopes, MLRA 14	Yes
CtC	Cotati fine sandy loam, 2 to 9 percent slopes	No
CtD	Cotati fine sandy loam, 9 to 15 percent slopes	No
CtE	Cotati fine sandy loam, 15 to 30 percent slopes	No
<b>Petaluma</b>		
CtC	Cotati fine sandy loam, 2 to 9 percent slopes	No
CtD	Cotati fine sandy loam, 9 to 15 percent slopes	No
GID	Goulding cobbly clay loam, 5 to 15 percent slopes	No
<b>Glen Ellen</b>		
CgD	Clough gravelly loam, 9 to 15 percent slopes	No
SkC	Spreckels loam, 2 to 9 percent slopes	No
SkE	Spreckels loam, 15 to 10 percent slopes	No

Map Unit Symbol	Map Unit Name	Hydric Soil
<b>Agua Caliente</b>		
CcA	Clear Lake clay loam, 0 to 2 percent slopes	Yes
CgC	Clough gravelly loam, 2 to 9 percent slopes	No
CgD	Clough gravelly loam, 9 to 15 percent slopes	No
LuA	Los Robles gravelly clay loam, 0 to 2 percent slopes	No
LvB	Los Robles gravelly clay loam, moderately deep, 0 to 5 percent slopes	No
RhD	Red Hill clay loam, 2 to 15 percent slopes	No
SkC	Spreckels loam, 2 to 9 percent slopes	No
TuC	Tuscan cobbly clay loam, 0 to 9 percent slopes	No
YnA	Yolo loam, 0 to 10 percent slopes, moist, MLRA 14	No
ZaA	Zamora silty clay loam, moist, 0 to 2 percent slopes, MLRA 14	No
<b>Sonoma</b>		
CcA	Clear Lake clay loam, 0 to 2 percent slopes	Yes
CgC	Clough gravelly loam, 2 to 9 percent slopes	No
CgD	Clough gravelly loam, 9 to 15 percent slopes	No
LuA	Los Robles gravelly clay loam, 0 to 2 percent slopes	No
LvB	Los Robles gravelly clay loam, moderately deep, 0 to 5 percent slopes	No
RhD	Red Hill clay loam, 2 to 15 percent slopes	No
SkC	Spreckels loam, 2 to 9 percent slopes	No
TuC	Tuscan cobbly clay loam, 0 to 9 percent slopes	No
YnA	Yolo loam, 0 to 10 percent slopes, moist, MLRA 14	No
ZaA	Zamora silty clay loam, moist, 0 to 2 percent slopes, MLRA 14	No

### 3.2 Vegetation and Other Land Cover

Vegetation communities and land cover types in the BSAs were developed based on aerial imagery and the Sonoma County Water Agency, Sonoma County Agricultural Preservation and Open Space District, Sonoma County Vegetation Mapping and LiDAR Program (Sonoma County 2018). Thirty-two vegetation communities and land cover types were identified, ranging from wetlands to grasslands and woodlands. The vegetation communities are described below. The mapping is presented in a land-cover map atlas (Appendix A, Figure 3), and provides a reasonable approximation of the types and acreages of the various vegetation communities and land-cover types that occur within the BSAs. Vegetation communities and land cover types mapped in the BSAs are presented in Table 3 below.

Sonoma County  
**Rezone Sites for Housing Project**

**Table 3 Vegetation Communities and Land Cover Types in the BSAs**

Vegetation Community or Land Cover Type	BSA											Total	
	AGU	FOR	GEY	GLE	GRA	GUE	LAR	PEN	PET	SAN	SON		
Pacific madrone ( <i>Arbutus menziesii</i> )						12.8							12.8
Barren			1.4							1.1			2.6
California Annual and Perennial Grassland	2.4	89.8	42.0	0.5	29.8	22.7	3.7	115.4	30.7	266.1	9.3		612.4
Deciduous Orchard		15.0	0.1		49.1	7.5							71.7
Deciduous Orchard, Vineyard, Irrigated Row and Field Crops					2.9								2.9
Eucalyptus ( <i>Eucalyptus</i> spp.) – tree of heaven ( <i>Ailanthus altissima</i> ) – black locust ( <i>Robinia pseudoacacia</i> )					2.2			2.3	0.4	3.6			8.5
Irrigated Hayfield						4.1				10.0			14.1
Irrigated Row and Field Crops							0.2			0.2	1.0		1.4
Non-native Forest & Woodland		48.6	2.6	0.3	17.1	10.1	4.5	20.4		7.7	1.4		112.8
Non-native Shrub		2.8			0.7	1.8							5.4
Tanoak ( <i>Notholithocarpus densiflorus</i> )						5.6							5.6
Fremont cottonwood ( <i>Populus fremontii</i> )	0.0	3.1				4.1	4.3						11.5
Douglas fir ( <i>Pseudotsuga menziesii</i> )		12.0			1.7	2.7							16.4
Oak ( <i>Quercus agrifolia</i> , <i>Q. douglasii</i> , <i>Q. garryana</i> , <i>Q. kelloggii</i> , <i>Q. lobata</i> , <i>Q. wislizeni</i> )		10.8		7.9	18.2		0.2						37.2
Coast live oak ( <i>Quercus agrifolia</i> )			13.5		11.1	2.4	3.8	4.7		0.0			35.5
Blue oak ( <i>Quercus douglasii</i> )			0.1										0.1
Oregon oak ( <i>Quercus garryana</i> ) (tree)		8.5											8.5
Valley oak ( <i>Quercus lobata</i> )	3.8	21.2		0.0	8.4		1.0				3.5		38.0

Vegetation Community or Land Cover Type	BSA											Total
	AGU	FOR	GEY	GLE	GRA	GUE	LAR	PEN	PET	SAN	SON	
Himalayan blackberry ( <i>Rubus armeniacus</i> ) - rattlebox ( <i>Sesbania punicea</i> ) – common fig ( <i>Ficus carica</i> )		1.4			0.1	2.6		1.2				5.4
Coast redwood ( <i>Sequoia sempervirens</i> )		1.6			18.2	146.7						166.5
Southwestern North American Riparian Evergreen and Deciduous Woodland	3.3	9.6				0.4	4.8	12.1				30.1
Southwestern North American Riparian/Wash Scrub		12.2			27.4	1.1				2.3		43.1
Temperate Forest		10.1	1.2	0.6	6.6	2.1	3.1	8.7	1.2	5.0	0.3	38.9
California bay ( <i>Umbellularia californica</i> )	6.4	1.8										8.2
Urban	126.6	163.4	47.1	16.6	148.4	104.2	177.9	140.1	28.3	525.1	23.5	1,501.0
Vancouverian Riparian Deciduous Forest	15.3	3.5	0.6	4.2	8.3	19.0	4.5	1.5				56.9
Vineyard		42.0	21.2		15.4	19.8	5.7	1.7	0.3		2.3	108.5
Water	0.1			0.0		0.0	0.0	0.1				0.2
Water Treatment Pond		2.7										2.7
Western North America Vernal Pool								0.4		4.4		4.8
Western North American Freshwater Aquatic Vegetation		0.1										0.1
Western North American Freshwater Marsh		1.4			5.0	0.7		0.2		5.7		12.9
<b>Total</b>	<b>157.8</b>	<b>462.0</b>	<b>129.9</b>	<b>30.1</b>	<b>370.5</b>	<b>370.2</b>	<b>213.7</b>	<b>308.7</b>	<b>61.0</b>	<b>831.3</b>	<b>41.3</b>	<b>2,976.5</b>



The vegetation community characterizations for this analysis were based on the classification systems presented in the *United States National Vegetation Classification* (USNVC) and *A Manual of California Vegetation, Second Edition* (Sawyer et al. 2009). The *Preliminary Description of Terrestrial Natural Communities of California* (Holland 1986) has been superseded by Sawyer et al. (2009). Many of the vegetation communities discussed below represent large areas which may be geographically isolated from one another, therefore lesser species components and overall cover may be highly variable from one location to the next. Plant species nomenclature and taxonomy used for this BRA follows the treatments within the second edition of *The Jepson Manual* (Baldwin et al. 2012).

#### *Pacific Madrone (Arbutus menziesii)*

This community most closely resembles the Pacific madrone (*Arbutus menziesii*) Forest - Alliance described by Sawyer et al. (2009). Pacific madrone is dominant or co-dominant in the broadleaf canopy with black oak (*Quercus kelloggii*) and/or bay laurel (*Umbellularia californica*). Douglas fir (*Pseudotsuga menziesii*), toyon (*Heteromeles arbutifolia*), and poison oak (*Toxicodendron diversilobum*) are often present. There are approximately 12.8 acres of *Arbutus menziesii* Alliance in the BSAs.

#### *Barren*

The BSAs contain approximately 2.6 acres of bare ground. This land cover type is not described in either the USNVC or Sawyer et al. (2009) classification systems, but is described by the California Wildlife Habitat Relationships (CWHR) system (Mayer and Laudenslayer 1988). This land cover type occurs where no vegetation is present and includes bare soil. This land cover type was mapped where bare soils were likely the result of disturbance such as development or construction activities. This land cover type was observed sporadically throughout the BSA.

#### *California Annual and Perennial Grassland*

This community includes the USNVC California Annual Herb/Grass Group and California Perennial Grasslands Group, including native and non-native grasslands in dry to seasonally moist settings outside of coastal areas. Species include, but are not limited to; oats (*Avena* spp.), mustard (*Brassica* spp.), bromes (*Bromus* spp.), Knapweed (*Centaurea* spp.), dogstail grass (*Cynosurus* spp.), blue wild rye (*Elymus glaucus*), California poppy (*Eschscholzia* spp.), California goldfields (*Lasthenia californica*), bluegrass (*Lolium* spp.), needlegrass (*Nassella* spp.), melic grass (*Melica* spp.), California plantain (*Plantago erecta*), western brackenfern (*Pteridium aquilinum*), fescue (*Vulpia microstachys*), and Rusty haired popcorn flower (*Plagiobothrys nothofulvus*). There are approximately 612.4 acres of California Annual and Perennial Grasslands in the BSAs.

#### *Deciduous Orchard*

This land cover type is not described by the USNVC or Sawyer et al. (2009) but is described by CWHR (Mayer and Laudenslayer 1988). Deciduous orchards include deciduous fruit and nut trees, such as apple (*Malus domestica*) and walnut (*Juglans* spp.), planted for commercial agriculture. They are typically planted in rows with an open, barren understory. There are approximately 71.7 acres of deciduous orchards in the BSAs.

### *Deciduous Orchard, Vineyard, Irrigated Row and Field Crops*

This land cover type is not described by the USNVC or Sawyer et al. (2009), but is described by CWHR (Mayer and Laudenslayer 1988), and includes deciduous orchards, vineyards, and irrigated row and field crops. Deciduous orchards are described above and may occur in areas mapped within this land cover type. Vineyards typically include rows of a single species supported on wood and wire trellises. Wine grapes (*Vitis* spp.) are the most commonly cultivated vineyard species in the BSAs. Irrigated row and field crops include cultivated agricultural crops, typically grown in rows. Most are annual species, though some may be perennial. There are approximately 2.9 acres of deciduous orchards, vineyards, and irrigated row and field crops in the BSAs.

### *Eucalyptus (Eucalyptus spp.) -- tree of heaven (Ailanthus altissima) -- black locust (Robinia pseudoacacia)*

This community is not described by the USNVC or Sawyer et al. (2009) and includes non-native evergreen and deciduous trees. Dominant species include *Eucalyptus (globulus, camaldulensis)*, tree-of-heaven (*Ailanthus altissima*), and black locust (*Robinia pseudoacacia*). These species are non-native and have a California Invasive Plant Counsel rating of Limited, Moderate, and Limited, respectively. There are approximately 8.5 acres of *Eucalyptus* spp. - *Ailanthus altissima* - *Robinia pseudoacacia* in the BSAs.

### *Irrigated Hayfield*

This land cover type is not described by the USNVC or Sawyer et al. (2009) but is described by CWHR (Mayer and Laudenslayer 1988). Irrigated hayfields include cultivated agricultural crops, typically monocultures grown in rows. Hayfields include alfalfa fields and grass hayfields. There are approximately 14.1 acres of irrigated hayfields in the BSAs.

### *Irrigated Row and Field Crops*

This land cover type is not described by the USNVC or Sawyer et al. (2009), but is described by CWHR (Mayer and Laudenslayer 1988), and is included in the deciduous orchard, vineyard, irrigated row and field crops as described above. Irrigated row and field crops include cultivated agricultural crops, typically grown in rows. Most are annual species, though some may be perennial. There are approximately 1.4 acres of irrigated row and field crops in the BSAs.

### *Non-native Forest & Woodland*

Non-native forest & woodlands are dominated by non-native, ornamental, or landscaped trees. The species included in this community are highly variable but may include; American sweetgum (*Liquidambar styraciflua*), Chinese elm (*Ulmus parvifolia*), date palm (*Phoenix dactylifera*), and Italian cypress (*Cupressus sempervirens*). There are approximately 112.8 acres of non-native forest & woodlands in the BSAs.

### *Non-native Shrub*

Non-native shrub communities are dominated by non-native, ornamental, or landscaped shrubs. The species included in this community are highly variable but may include; holly (*Ilex aquifolium*), rose of Sharon (*Hibiscus syriacus*), lilac (*Syringa vulgaris*), and rose (*Rosa* spp.). There are approximately 5.4 acres of non-native shrub communities in the BSAs.

*Tanoak (Notholithocarpus densiflorus)*

This community most closely resembles the tanoak (*Notholithocarpus densiflorus*) Forest Alliance described by Sawyer et al. (2009). Tanoak is dominant or co-dominant in the broadleaf canopy with Pacific madrone. There are approximately 5.6 acres of *Notholithocarpus densiflorus* Alliance in the BSAs.

*Fremont Cottonwood (Populus fremontii)*

This community most closely resembles the Fremont cottonwood (*Populus fremontii*) Forest Alliance described by Sawyer et al. (2009). Fremont cottonwood is dominant or co-dominant in the broadleaf canopy with Pacific madrone. There are approximately 11.5 acres of *Populus fremontii* Alliance in the BSAs.

*Douglas Fir (Pseudotsuga menziesii)*

This community most closely resembles the Douglas fir (*Pseudotsuga menziesii*) Forest & Woodland Alliance described by Sawyer et al. (2009). Douglas fir is dominant or co-dominant with Pacific madrone, coast live oak (*Quercus agrifolia*), canyon live oak (*Quercus chrysolepis*), Bay laurel or other hardwoods except tanoak. Oregon white oak (*Quercus garryana*) and California black oak (*Quercus kelloggii*) may also be present at less than 30 percent of relative cover. There are approximately 16.4 acres of *Pseudotsuga menziesii* Alliance in the BSAs.

*Oak (Quercus agrifolia, Q. douglasii, Q. garryana, Q. kelloggii, Q. lobata, Q. wislizeni)*

This community most closely resembles the *Quercus (agrifolia, douglasii, garryana, kelloggii, lobata, wislizeni)* Forest & Woodland Alliance described by Sawyer et al. (2009). In this community three or more oak species are present and collectively dominate or co-dominate the broadleaf canopy, making it difficult to assign an alliance defined by one oak species. Oak species may include coast live oak, blue oak (*Quercus douglasii*), Oregon white oak, California black oak, valley oak (*Quercus lobata*), and interior live oak (*Quercus wislizeni*). There are approximately 37.2 acres of *Quercus (agrifolia, douglasii, garryana, kelloggii, lobata, wislizeni)* Alliance in the BSAs.

*Coast Live Oak (Quercus agrifolia)*

This community most closely resembles the coast live oak (*Quercus agrifolia*) Woodland & Forest Alliance described by Sawyer et al. (2009). Coast live oak is dominant or co-dominant with Pacific madrone. The understory often contains a mixture of native and non-native herbs and/or shrubs. There are approximately 35.5 acres of *Quercus agrifolia* Alliance in the BSAs.

*Blue Oak (Quercus douglasii)*

This community most closely resembles the blue oak (*Quercus douglasii*) Forest & Woodland Alliance described by Sawyer et al. (2009). Blue oak and/or *Quercus x eplingii* (the hybrid between blue oak and Oregon white oak) is dominant or co-dominates with coast live oak or Pacific madrone in the broadleaf canopy. The understory is often moderately dense to dense, with a mixture of native and non-native forbs and grasses. There is approximately <0.1 acre of *Quercus douglasii* Alliance in the BSAs.

### Oregon Oak (*Quercus garryana*) (tree)

This community most closely resembles the Oregon white oak (*Quercus garryana*) (tree) Forest & Woodland Alliance described by Sawyer et al. (2009). Oregon white oak is dominant or co-dominant with up to two other species. Douglas fir, bay laurel, coast live oak, and California black oak are often present. This community may have a dense canopy with little understory, or a more open canopy with native and non-native herbs such as rough dog's-tail (*Cynosurus echinatus*) and California fescue (*Festuca californica*). There are approximately 8.5 acres of *Quercus garryana* (tree) Alliance in the BSAs.

### Valley Oak (*Quercus lobata*)

This community most closely resembles the valley oak (*Quercus lobata*) Forest & Woodland Alliance described by Sawyer et al. (2009). Valley oak is dominant or co-dominant, often with coast live oak or Oregon ash (*Fraxinus latifolia*). The understory commonly includes California wild rose (*Rosa californica*), blackberry (*Rubus* spp.), and poison oak. There are approximately 38.0 acres of *Quercus lobata* Alliance in the BSAs.

### Himalayan Blackberry (*Rubus armeniacus*) - rattlebox (*Sesbania punicea*) -- common fig (*Ficus carica*)

This community most closely resembles the Himalayan blackberry (*Rubus armeniacus*) – rattlebox (*Sesbania punicea*) – common fig (*Ficus carica*) Shrubland Semi-Natural Alliance described by Sawyer et al. (2009). Himalayan blackberry, rattlebox, or common fig are dominant. This community occurs in riparian, mesic, and disturbed sites. There are approximately 5.4 acres of *Rubus armeniacus* - *Sesbania punicea* - *Ficus carica* Alliance in the BSAs.

### Coast Redwood (*Sequoia sempervirens*)

This community most closely resembles the redwood (*Sequoia sempervirens*) Forest & Woodland Alliance described by Sawyer et al. (2009). Coast redwood is dominant or co-dominant, often with big leaf maple (*Acer macrophyllum*), tanoak, Douglas fir, California nutmeg (*Torreya californica*), and bay laurel. There are approximately 166.5 acres of *Sequoia sempervirens* Alliance in the BSAs.

### Southwestern North American Riparian Evergreen and Deciduous Woodland

This community is not described by the USNVC or Sawyer et al. (2009). Southwestern north American riparian evergreen and deciduous woodlands includes the boxelder maple (*Acer negundo*) Alliance, California black walnut (*Juglans hindsii*) and Hybrids Alliance, and the polished willow (*Salix laevigata*) Alliance. This community may also include Fremont cottonwood as a minor component and is typically found in riparian areas. There are approximately 30.1 acres of southwestern North American riparian evergreen and deciduous woodland in the BSAs.

### Southwestern North American Riparian/Wash Scrub

This community is not described by the USNVC or Sawyer et al. (2009). Southwestern north American riparian/wash scrub includes the California coffeeberry (*Frangula californica*) - western azalea (*Rhododendron occidentale*) Alliance, Brewer's willow (*Salix breweri*) Alliance, narrow leaved willow (*Salix exigua*) Alliance, dusky willow (*Salix melanopsis*) Alliance, black elderberry (*Sambucus nigra*) Alliance, Arroyo willow (*Salix lasiolepis*) Alliance. This community may also include blackberry or coyote brush (*Baccharis pilularis*) and is typically found in riparian areas with permanent soil

saturation. There are approximately 43.1 acres of southwestern North American riparian evergreen and deciduous woodland in the BSAs.

### *Temperate Forest*

This community is very broad and is not described by the USNVC or Sawyer et al. (2009). Temperate Forests are found between the subtropical and subarctic climates. Within Sonoma County temperate forests include deciduous and coniferous forests. Species composition within this community is highly variable, and many of the deciduous and coniferous species alliances discussed in this report are considered temperate forests. There are approximately 38.9 acres of temperate forest in the BSAs.

### *California bay (Umbellularia californica)*

This community most closely resembles the bay laurel (*Umbellularia californica*) Forest & Woodland Alliance described by Sawyer et al. (2009). Bay laurel is dominant or co-dominant with coast live oak, the canopy cover may be dense to open. There are approximately 8.2 acres of *Umbellularia californica* Alliance in the BSAs.

### *Urban*

This land cover type is not described by the USNVC or Sawyer et al. (2009) but is described by CWHR (Mayer and Laudenslayer 1988). The urban land cover type includes fully developed areas that are part of a developed urban core. This includes residential, commercial, and industrial development. There are approximately 1501.0 acres of urban areas in the BSAs.

### *Vancouverian Riparian Deciduous Forest*

This community is very broad and is not described by the USNVC or Sawyer et al. (2009). Vancouverian riparian deciduous forest includes the white alder (*Alnus rhombifolia*) Alliance, Oregon alder (*Alnus rubra*) Alliance, Oregon ash (*Fraxinus latifolia*) Alliance, and shining willow (*Salix lucida*) Alliance. Big leaf maple and/or bay laurel may be co-dominant. This community is found in riparian areas. There are approximately 56.9 acres of Vancouverian riparian deciduous woodland in the BSAs.

### *Vineyard*

This land cover type is not described by the USNVC or Sawyer et al. (2009) but is described by CWHR (Mayer and Laudenslayer 1988), and is included in the deciduous orchard, vineyard, irrigated row and field crops as described above. Vineyards typically include rows of a single species supported on wood and wire trellises. Wine grapes are the most commonly cultivated vineyard species in the BSAs. There are approximately 108.5 acres of vineyards in the BSAs.

### *Water*

This land cover type is not described by the USNVC or Sawyer et al. (2009). Areas mapped as water include ponds and pools, which may be isolated or associated with streams or creeks. There is approximately 0.2 acre of water in the BSAs.

### Water Treatment Pond

This land cover type is not described by the USNVC or Sawyer et al. (2009) and includes the water treatment ponds at the Forestville Water Quality Control Plant. There are approximately 2.7 acres of water treatment ponds in the BSAs.

### Western North America Vernal Pool

This land cover type is not described by the USNVC or Sawyer et al. (2009). Western north America vernal pool includes vernal pools of the Santa Rosa Plain and adjacent areas. Vernal pools are isolated seasonal wetlands or vernal influenced marshes and are typically dominated by common spikerush (*Eleocharis macrostachya*), smooth goldfields (*Lasthenia glaberrima*), or annual semaphoregrass (*Pleuropogon californicus*). There are approximately 4.8 acres of vernal pools in the BSAs.

### Western North American Freshwater Aquatic Vegetation

This community is not described by the USNVC or Sawyer et al. (2009). Western north America freshwater aquatic vegetation includes floating aquatic vegetation such as mosquito ferns (*Azolla* spp.), watershield (*Brasenia* spp.), hornworts (*Ceratophyllum* spp.), duck weed (*Lemna* spp.), water primrose (*Ludwigia* spp.), or water lily (*Nuphar* spp.). There is approximately 0.1 acre of freshwater aquatic vegetation in the BSAs.

### Western North American Freshwater Marsh

This community is not described by the USNVC or Sawyer et al. (2009). Western north America freshwater marsh includes marsh and wet meadow habitats. This community is typically dominated by silverweed (*Argentina* spp.), sand dune sedge (*Carex pansa*), slough sedge (*C. obnupta*), California field sedge (*C. praegracilis*), common rush (*Juncus effuses*), dune rush (*J. lescurii*), common rush (*J. patens*), water dropworts (*Oenanthe* spp.), bulrush (*Schoenoplectus* spp.), mountain bog bulrush (*Scirpus microcarpus*), and/or cattails (*Typha* spp.). There are approximately 12.9 acres of freshwater marsh in the BSAs.

## 3.3 General Wildlife

Wildlife that can reasonably be expected to occur in the BSA varies based on habitat type and availability. These BSAs are located largely in developed, urban or semi-rural areas. The Larkfield, Graton, Forestville, Santa Rosa, Penngrove, Petaluma, Agua Caliente, and Sonoma BSAs are located on the Sonoma valley floor in central/southern Sonoma County. Common avian species in and adjacent to urban areas in this region include California quail (*Callipepla californica*), red-tailed hawk (*Buteo jamaicensis*), red-shouldered hawk (*Buteo lineatus*), house finch (*Haemorhous mexicanus*), common raven (*Corvus corax*), red-winged blackbird (*Agelaius phoeniceus*), Cooper's hawk (*Accipiter cooperii*), and California scrub jay (*Aphelocoma californica*). Reptile species known from the region include gopher snake (*Pituophis catenifer*), northwestern fence lizard (*Sceloporus occidentalis occidentalis*), California kingsnake (*Lampropeltis californiae*), and the northern pacific rattlesnake – (*Crotalus oreganus oreganus*). Typical mammalian species include disturbance tolerant species common in urban areas, including gray fox (*Urocyon cinereoargenteus*), common raccoon (*Procyon lotor*), Virginia opossum (*Didelphis virginiana*), western gray squirrel (*Sciurus griseus*), and bobcat (*Lynx rufus*).

Sonoma County  
**Rezone Sites for Housing Project**

The Guerneville and Glen Ellen BSAs are in developed areas as well, but in mountains with woodland habitats interspersed throughout and surrounding the BSA. Avian species reasonably be expected to occur in these areas include turkey vulture (*Cathartes aura*), Stellar's jay (*Cyanocitta stelleri*), California scrub jay, red-shouldered hawk, red-tailed hawk, wild turkey (*Meleagris gallopavo*) and barn owl (*Tyto alba*). Reptile species observed include western fence lizard (*Sceloporus occidentalis*), southern alligator lizard (*Elgaria multicolor*) and western rattlesnake (*Crotalus oreganus*). Mammalian species typical of the area include mule deer (*Odocoileus hermionus*), western gray squirrel, gray fox, mountain lion (*Puma concolor*), dusky-footed woodrat (*Neotoma fuscipes*), Virginia opossum, coyote (*Canis latrans*), common raccoon and bobcat.

The Geyserville BSA is located on the Alexander Valley floor surrounded by development in northern Sonoma County. Avian species in and adjacent to urban areas in this region include red-tailed hawk, California scrub jay, acorn woodpecker (*Melanerpes formicivorus*), and American crow. Mammalian species observed include gray fox, mule deer, and dusky-footed woodrat.

## 4 Sensitive Biological Resources

---

Local, State, and federal agencies regulate special status species and other sensitive biological resources and require an assessment of their presence or potential presence to be conducted on site prior to the approval of proposed development on a property. This section discusses sensitive biological resources observed on the project site and evaluates the potential for the project site to support additional sensitive biological resources. Assessments for the potential occurrence of special status species are based upon known ranges, habitat preferences for the species, species occurrence records from the CNDDDB, species occurrence records from other sites in the vicinity of the survey area, and previous reports for the project site. The potential for each special status species to occur in the study area was evaluated according to the following criteria:

1. **No Potential.** Habitat on and adjacent to the site is clearly unsuitable for the species requirements (foraging, breeding, cover, substrate, elevation, hydrology, plant community, site history, disturbance regime), and species would have been identifiable on-site if present (e.g., oak trees). Protocol surveys (if conducted) did not detect species.
2. **Low Potential.** Few of the habitat components meeting the species requirements are present, and/or the majority of habitat on and adjacent to the site is unsuitable or of very poor quality. The species is not likely to be found on the site. Protocol surveys (if conducted) did not detect species.
3. **Moderate Potential.** Some of the habitat components meeting the species requirements are present, and/or only some of the habitat on or adjacent to the site is unsuitable. The species has a moderate probability of being found on the site.
4. **High Potential.** All the habitat components meeting the species requirements are present and/or most of the habitat on or adjacent to the site is highly suitable. The species has a high probability of being found on the site.
5. **Present.** Species is observed on the site or has been recorded (e.g., CNDDDB, other reports) on the site recently (within the last 5 years).

### 4.1 Special Status Species

#### Special Status Plant Species

In the region, 160 special status plant species are known to occur, and these were evaluated for their potential to occur in the BSAs (Appendix C). Based on the size of the BSAs and the types and quality of natural vegetation communities there, 82 special status plant species could be excluded based on the lack of species-specific habitat features in the BSAs. The specific habitat features absent from the BSAs include, but are not limited to, coastal dunes, salt marsh, chaparral, and closed-cone coniferous forest. Special status plants generally have a low potential to occur in the BSAs due to the developed nature of most of the sites, but many of the BSAs are adjacent to undeveloped areas and overlap some portion of natural habitats and aquatic features. A total of 78 special status plant species have potential to occur in the BSA (Appendix C). Those plants federally- and/or State-listed as endangered or threatened, or presumed present are listed in Table 4 and Table 5 below. Four species have been documented in the BSAs, including one federally listed species (Table 5). The remaining 52 species with potential to occur have a California Rare Plant Rank (CRPR) of 1B to 2B (Appendix C).



**Table 4 Federal and State-listed Plant Species with Potential to Occur in the BSA**

Common Name	Scientific Name	Status	BSA
<b>Low Potential to Occur</b>			
Baker's manzanita	<i>Arctostaphylos bakeri</i> ssp. <i>bakeri</i>	SR	GEY, GUE, LAR, FOR, GRA, SAN, GLE, AGU, PEN, PET, SON
Marin manzanita	<i>Arctostaphylos virgata</i>	FE/SCE	GUE, GLE
Clara Hunt's milk-vetch	<i>Astragalus claranus</i>	FE/ST	GEY, GUE, LAR, FOR, GRA, SAN, GLE, AGU, PEN, PET, SON
Vine Hill clarkia	<i>Clarkia imbricata</i>	FE/SE	GEY, GUE, LAR, FOR, GRA, SAN, GLE, AGU, PEN, PET, SON
Baker's larkspur	<i>Delphinium bakeri</i>	FE/SE	GEY, GUE, LAR, FOR, GRA, SAN, GLE, AGU, PEN, PET, SON
Mason's lilaepsis	<i>Lilaeopsis masonii</i>	SR	GEY, GUE, LAR, FOR, GRA, SAN, GLE, AGU, PEN, PET, SON
Geysers panicum	<i>Panicum acuminatum</i> var. <i>thermale</i>	SE	GEY, PET, SON
North Coast semaphore grass	<i>Pleuropogon hooverianus</i>	ST	GEY, GUE, LAR, FOR, GRA, SAN, GLE, AGU, PEN, PET, SON
Two-fork clover	<i>Trifolium amoenum</i>	FE	GEY, GUE, LAR, FOR, GRA, SAN, GLE, AGU, PEN, PET, SON
<b>Moderate Potential to Occur</b>			
Sonoma alopecurus	<i>Alopecurus aequalis</i> var. <i>sonomensis</i>	FE	GUE, LAR, GRA, SAN, GLE, AGU, PEN, SON
Sonoma sunshine	<i>Blennosperma bakeri</i>	FE/SE	SAN, PEN
Pitkin Marsh paintbrush	<i>Castilleja uliginosa</i>	SE	GUE, LAR, FOR, GRA, SAN, GLE, AGU, PEN, SON
Loch Lomond button-celery	<i>Eryngium constancei</i>	FE/SE	SAN, PEN
Boggs Lake hedge-hyssop	<i>Gratiola heterosepala</i>	SE	GUE, LAR, FOR, GRA, SAN, GLE, AGU, PEN, SON
Burke's goldfields	<i>Lasthenia burkei</i>	FE/SE	GUE, LAR, FOR, GRA, SAN, GLE, AGU, PEN, SON
Contra Costa goldfields	<i>Lasthenia conjugens</i>	FE	GUE, LAR, FOR, GRA, SAN, GLE, AGU, PEN, SON
Pitkin Marsh lily	<i>Lilium pardalinum</i> ssp. <i>pitkinense</i>	FE/SE	GUE, LAR, FOR, GRA, SAN, GLE, AGU, PEN, SON
Sebastopol meadowfoam	<i>Limnanthes vinculans</i>	FE/SE	SAN, PEN
few-flowered navarretia	<i>Navarretia leucocephala</i> ssp. <i>pauciflora</i>	FE/ST	SAN, PEN
Many-flowered navarretia	<i>Navarretia leucocephala</i> ssp. <i>plieantha</i>	FE/SE	SAN, PEN
Geysers panicum	<i>Panicum acuminatum</i> var. <i>thermale</i>	SE	GUE, LAR, FOR, GRA, SAN, GLE, AGU, PEN, SON

Common Name	Scientific Name	Status	BSA
Kenwood Marsh checkerbloom	<i>Sidalcea oregana ssp. valida</i>	FE/SE	GUE, LAR, FOR, GRA, SAN, GLE, AGU, PEN, SON
Pacific Grove clover	<i>Trifolium polyodon</i>	SR	GUE, LAR, FOR, GRA, SAN, GLE, AGU, PEN, SON

FP = State Fully Protected    FT = Federal Threatened    FE = Federal Endangered    SR = State Rare    ST = State Threatened  
SE = State Endangered    SCE = State Candidate Endangered

**Table 5 Special Status Plants Documented in the BSA**

Common Name	Scientific Name	Status	BSA
<b>Present</b>			
Congested-headed hayfield tarplant	<i>Hemizonia congesta ssp. congesta</i>	1B.2	AGU, PEN, SON
Sonoma alopecurus	<i>Alopecurus aequalis var. sonomensis</i>	FE	FOR
Holly-leaved ceanothus	<i>Ceanothus purpureus</i>	1B.2	GUE
Pappose tarplant	<i>Centromadia parryi ssp. parryi</i>	1B.2	PEN

## Special Status Animal Species

In the region, 62 special status animal species are known to occur and these were evaluated for their potential to occur in the BSAs (Appendix C). Based on the size of the BSAs and the types and quality of natural vegetation communities there, 26 special status animal species could be excluded based on the lack of species-specific habitat features present in the BSAs. These species generally occur in marine or salt marsh habitats, and the BSAs are outside of the species known range. Special status animals generally have a low potential to occur in the BSAs due to the developed nature of most of the sites; however, many of the BSAs are located adjacent to undeveloped areas and overlap some portion of natural habitats and aquatic features. Thirty-six special status animal species have some potential to occur in the BSA, including 19 federally or State-listed species (Table 6).

## Other Protected Species

### *Nesting Birds*

Non-game migratory birds protected under the CFGC Section 3503 have the potential to breed throughout the BSA. Native avian species common to oak woodland, riparian and coastal scrub, grasslands, landscaping, developed and ruderal areas have the potential to breed and forage throughout the BSA. Species of birds common to the area that typically occur in the region, including red-tailed hawk, California quail, California scrub jay, black phoebe (*Sayornis nigricans*), Anna's hummingbird (*Calypte anna*), house finch (*Haemorhous mexicanus*), American crow, and turkey vulture, were detected from online database sources, including iNaturalist and eBird. Nesting by a variety of common birds protected by CFGC Section 3503 could occur in virtually any location throughout the BSA.

**Table 6 Federal and State-listed Animals with Potential to Occur in the BSA**

Common Name	Scientific Name	Status	BSA
<b>Low Potential to Occur</b>			
Crotch bumble bee	<i>Bombus crotchii</i>	SC	GEY, GUE, LAR, FOR, GRA, SAN, GLE, AGU, PEN, PET, SON
Western bumble bee	<i>Bombus occidentalis</i>	SC	GEY, GUE, LAR, FOR, GRA, SAN, GLE, AGU, PEN, PET, SON
California freshwater shrimp	<i>Syncaris pacifica</i>	FE, SE	GUE, LAR, GRA, GLE, PEN
Coho salmon - central California coast ESU	<i>Oncorhynchus kisutch pop. 4</i>	FE, SE	GLE, AGU, PEN, SON
Steelhead – central California coast DPS	<i>Oncorhynchus mykiss irideus pop. 8</i>	FT	GRA, SON
California tiger salamander-Sonoma County DPS	<i>Ambystoma californiense pop. 3</i>	FT, ST	GUE, LAR, FOR, GRA, GLE, AGU, PET, SON
California red-legged frog	<i>Rana draytonii</i>	FT	GEY, LAR, FOR, GRA, SAN, GLE, AGU, PEN, PET, SON
Tricolored blackbird	<i>Agelaius tricolor</i>	ST	GUE, LAR, FOR, GRA, SAN, GLE, AGU, PEN, SON
Swainson’s hawk	<i>Buteo swainsoni</i>	ST	GEY, GUE, LAR, FOR, GRA, SAN, GLE, AGU, PEN, SON
northern spotted owl	<i>Strix occidentalis cauring</i>	FT/ST	GUE, FOR
<b>Moderate Potential to Occur</b>			
coho salmon – central California coast ESU	<i>Oncorhynchus kisutch pop. 4</i>	FE, SE	GRA
steelhead – central California coast DPS	<i>Oncorhynchus mykiss irideus pop. 8</i>	FT	LAR, GLE, AGU, PEN
foothill yellow-legged frog – north coast DPS	<i>Rana boylei pop. 1</i>	SC	GUE, LAR, PEN
California red-legged frog	<i>Rana draytonii</i>	FT	GUE
<b>High Potential to Occur</b>			
California tiger salamander - Sonoma county DPS	<i>Ambystoma californiense pop. 3</i>	FT, ST	PEN
<b>Present</b>			
California freshwater shrimp	<i>Syncaris pacifica</i>	FE, SE	AGU
coho salmon - central California coast ESU	<i>Oncorhynchus kisutch pop. 4</i>	FE, SE	GUE, LAR
steelhead – central California coast DPS	<i>Oncorhynchus mykiss irideus pop. 8</i>	FT	GUE
California tiger salamander-Sonoma county DPS	<i>Ambystoma californiense pop. 3</i>	FT, ST	SAN
FT = Federal Threatened	FE = Federal Endangered	ST = State Threatened	SE = State Endangered
SC = State Candidate	ESU = Evolutionarily Significant Unit DPS = Distinct Population Segment		

## 4.2 Sensitive Plant Communities and Critical Habitats

### Sensitive Natural Communities

Plant communities are considered sensitive biological resources if they have limited distribution, have high wildlife value, include sensitive species, or are particularly susceptible to disturbance. CDFW ranks sensitive communities as “threatened” or “very threatened” and keeps records of their occurrences in CNDDDB. Sensitive natural communities included in the CNDDDB follow the original methodology according to *Preliminary Descriptions of the Terrestrial Natural Communities of California* (Holland 1986). The methodology for determining sensitivity continues to be revised and is now based on the *Manual of California Vegetation* (Sawyer et al. 2009). Communities considered sensitive by CDFW are published in the California Sensitive Natural Communities List (CDFW 2022). Vegetation alliances are ranked 1 through 5 based on NatureServe’s (2010) methodology, with those alliances ranked globally (G) or statewide (S) as 1 through 3 considered sensitive. Some alliances with the rank of 4 and 5 have also been included in the 2018 sensitive natural communities list under CDFW’s revised ranking methodology (CDFW 2022c).

Five sensitive natural communities are known to occur within 5 miles of the BSAs:

1. Northern Vernal Pool
2. Coastal and Valley Freshwater Marsh
3. Northern Hardpan Vernal Pool
4. Valley Needlegrass Grassland
5. Coastal Brackish Marsh

The vegetation communities mapped in the Santa Rosa and Penngrove BSAs include Western North America Vernal Pool, which may be considered sensitive as a wetland. Additionally, many of the specific vegetation alliances in the BSAs may be considered sensitive under CDFW’s revised ranking methodology (CDFW 2022c), including the *Populus fremontii* – Forest Alliance, many *Quercus* sp. alliances, and the *Sequoia sempervirens* Forest & Woodland Alliance.

### Critical Habitats

Eight federally designated critical habitats occur within 5 miles of the BSAs:

1. Marbled murrelet
2. Northern spotted owl
3. California tiger salamander
4. California red-legged frog
5. Coho salmon – central California coast Evolutionarily Significant Unit (ESU)
6. Steelhead – central California DPS
7. Green sturgeon - southern DPS (*Acipenser medirostris*)
8. Chinook salmon – California coastal ESU (*Oncorhynchus tshawytscha*)

The BSAs distance in miles from each of the eight critical habitats is shown in Table 7 below. Critical habitat for California tiger salamander (CTS), coho salmon, and steelhead occur in some of the BSAs. Descriptions of each federally designated critical habitat are discussed below.

**Table 7 BSA Distance (miles) from Eight Federally Designated Critical Habitats**

BSA	Marbled Murrelet	Northern Spotted Owl	California Tiger Salamander	California Red legged Frog	Coho Salmon	Steelhead	Green Sturgeon	Chinook Salmon
Geyserville	n/a	n/a	n/a	n/a	1.94	0.88	n/a	0.38
Guerneville	0.88	n/a	n/a	n/a	Within BSA	Within BSA	n/a	n/a
Forestville	n/a	n/a	2.55	n/a	Within BSA	0.16	n/a	n/a
Larkfield	n/a	n/a	0.31	n/a	Within BSA	Within BSA	n/a	n/a
Graton	n/a	n/a	1.45	n/a	Within BSA	Within BSA	n/a	n/a
Santa Rosa	n/a	n/a	Within BSA	4.29	2.6	n/a	n/a	n/a
Penngrove	n/a	n/a	Within BSA	3.22	n/a	0.09	n/a	n/a
Petaluma	n/a	n/a	2.98	0.97	n/a	1.02	2.75	n/a
Glen Ellen	n/a	n/a	n/a	3.26	n/a	Within BSA	n/a	n/a
Agua Caliente	n/a	3.42	n/a	3.61	n/a	Within BSA	n/a	n/a
Sonoma	n/a	4.01	n/a	n/a	n/a	0.11	n/a	n/a

*Marbled Murrelet*

Marbled murrelet critical habitat unit CA-08-b is in the Armstrong Redwoods State Preserve, approximately 0.88 mile northwest of the Guerneville BSA (USFWS 2011a). Marbled murrelet are known to nest in most of the major types of coniferous forests in the western portions of Washington, Oregon, and California where older forests remain inland of the coast. The critical habitat is designated for potential nesting or roosting areas.

*Northern Spotted Owl*

Northern spotted owl critical habitat unit 11: Interior California Coast, subunit ICC-6 is in the Mayacamas Mountain Range. This critical habitat unit is approximately 3.42 miles east of the Agua Caliente BSA and 4.01 miles northeast of the Sonoma BSA. The ICC-6 subunit consists of approximately 2,072 acres of State and federal lands in Napa and Sonoma Counties. The federal register identifies the subunit as an essential conservation area due to its unique oak woodland habitat used by northern spotted owls.

*California Tiger Salamander*

The Santa Rosa Plain Unit is a total of 55,800 acres of land designated as critical habitat for CTS in Sonoma County (USFWS 2011b). This critical habitat extends from Penngrove in the south up to Windsor in the north, and includes tributaries, creeks, and streams, such as Pool Creek, Mark West Creek, Santa Rosa Creek, Gossage Creek, Washoe Creek, and Willow Brook. The Santa Rosa Plain Unit is within most of the Penngrove BSA, except for the northern portion and eastern edge of the BSA. Most of the BSA that is within critical habitat is developed, except for Lichau Creek. The critical habitat unit is also within all of the Santa Rosa BSA; however, the BSA is situated in urban development with little natural riparian/aquatic habitat. Threats identified in the federal register for this critical habitat include habitat destruction, degradation, and fragmentation, predation and competition from non-native species, possible commercial overutilization, disease, hybridization with non-native salamanders, various chemical contaminants, road-crossing mortality, and rodent control operations.

### *California Red-legged Frog*

The BSAs that are within 5 miles of the following California red-legged frog critical habitat units: SON-1, *Annadel*, SON-2, *Sonoma Mountain*, and SON-3, *Petaluma*. The SON-1 unit is comprised of approximately 1,564 acres of land and is located in Trione-Annadel State Park southeast of Santa Rosa. The SON-2 unit is comprised of approximately 4,932 acres of land and is located east of Petaluma in the Sonoma Mountains. The SON-3 unit is comprised of approximately 2,230 acres of land and is located southwest of Petaluma, near West Petaluma Regional Park. All three units contain aquatic habitat for breeding and non-breeding activities and upland habitat for foraging and dispersal activities. The BSAs within 5 miles of the critical habitat include the Santa Rosa BSA, approximately 4.29 miles, the Penngrove BSA, approximately 3.22 miles away, the Petaluma BSA, approximately 0.97 miles away, the Glen Ellen BSA, approximately 3.26 miles away, and the Agua Caliente BSA, approximately 3.61 miles away.

### *Coho Salmon*

The Atascadero Creek and Russian River and its tributaries, including Mark West Creek, Fife Creek, and Green Valley Creek, are designated critical habitat for central California coast ESU coho salmon. These watersheds provide suitable spawning and rearing sites, with adequate water quality, shade, and submerged logs and debris, which are essential for the conservation of the species. Furthermore, the Russian River preserves genetic and ecological attributes. The Guerneville, Forestville, Larkfield, and Granton BSAs are within coho salmon critical habitat.

### *Steelhead*

The Sonoma Creek and Russian River and its tributaries, including Mark West Creek and Green Valley Creek, are designated critical habitat for central California DPS steelhead. These watersheds provide suitable spawning and rearing sites, with adequate water quality, shade, and submerged logs and debris, which are essential for the conservation of the species. The Guerneville, Larkfield, Granton, Glen Ellen, and Agua Caliente BSAs are within steelhead critical habitat.

### *Green Sturgeon*

The San Pablo Bay is designated critical habitat for the green sturgeon southern DPS, including an area approximately 329 square kilometers. The critical habitat provide space for individual and population growth, shelter, sites for breeding, reproduction, rearing of offspring and protection from disturbance. Reduction of potential spawning habitat has been identified as a severe threat by the federal register. The Petaluma BSA is approximately 2.75 miles southeast of the critical habitat.

### *Chinook Salmon*

The Russian River and its tributaries, including Wood Creek, are designated critical habitat for central California DPS steelhead. The Geyserville BSA is approximately 0.38 miles northeast of the critical habitat but no suitable streams or rivers are present on the BSA. These watersheds provide suitable spawning and rearing sites, with adequate water quality, shade, and submerged logs and debris, which are essential for the conservation of the species.

## 4.3 Jurisdictional Waters and Wetlands

Potentially jurisdictional areas in the BSA include streams located at various locations within the 11 Urban Service Areas. There are 10 streams in the 11 Urban Service Areas: Sonoma Creek, Green Valley Creek, Wood Creek, Calabazas Creek, Atascadero Creek, Fife Creek, Mark West Creek, Petaluma River, Fife Creek and Lichau Creek (U.S. Geological Survey 2020). One freshwater pond is located in the Forestville BSA. There are no jurisdictional waters or wetlands within the Petaluma, Santa Rosa, or Sonoma BSA.

The above-described features are potentially subject to USACE, RWQCB, CDFW, and California Coastal Commission oversight. The lakes and many of the wetlands are permanently wet and have a direct hydrologic connection to the Pacific Ocean (a traditional navigable water as defined by USACE). The USACE is expected to assert jurisdiction under Section 404 of the Clean Water Act (CWA) over stream, lake, and wetland features to the ordinary high water mark, and to the edge of those wetlands with all three criteria that define federal wetlands: hydric soils, hydrophytic vegetation, and wetland hydrology. The RWQCB also has jurisdiction over waters of the U.S. under Section 401 of the CWA. The RWQCB may also assert jurisdiction over waters of the State under the Porter-Cologne Water Quality Control Act.

The CDFW has jurisdiction over lakes, streams, and associated riparian areas under the CGFC Section 1600 et seq. The CDFW has traditionally regulated activities within the bed and bank of lakes and streams, extending to the top of bank or edge of the riparian dripline, under its Lake and Streambed Alteration Program. The CDFW may also regulate activities conducted adjacent to but outside these areas, if the activity results in a substantial alteration of the stream or lakebed downslope of the activity, such as through placement of materials that wash into a water body.

## 4.4 Wildlife Movement

Wildlife movement corridors, or habitat linkages, are generally defined as connections between habitat patches that allow for physical and genetic exchange between otherwise isolated animals populations or those populations that are at risk of becoming isolated. Such linkages may serve a local purpose, such as providing a linkage between foraging and denning areas, or they may be regional in nature. Some habitat linkages may serve as migration corridors, wherein animals periodically move away from an area and then subsequently return. Others may be important as dispersal corridors for young animals. A group of habitat linkages in an area can form a wildlife corridor network. The California Essential Habitat Connectivity Project, commissioned by the California Department of Transportation and CDFW, identifies “natural Landscape Blocks” that support native biodiversity and the “Essential Connectivity Areas” which link them (Spencer et al. 2010).

Wildlife movement corridors can be both large and small in scale. Riparian corridors and waterways including Russian River, Petaluma River, Wood Creek, Mark West Creek, Sonoma Creek, Atascadero Creek, Fife Creek, Green Valley Creek, Calabazas Creek and Lichau Creek provide local scale opportunities for wildlife movement throughout the 11 BSAs. Existing trails and roads within the BSAs also act as corridors for wildlife movement, particularly for relatively disturbance tolerant species such as red fox, coyote, raccoon, skunk, deer, and bobcat. On a larger scale, one of the 11 BSAs is mapped in an Essential Connectivity Area in the Biogeographic Information and Observation System (CDFW 2022b). The Guerneville BSA is mapped within an Essential Connectivity Area connecting two natural land blocks, Armstrong Redwoods State Preserve at the northern extent and

the Sonoma Coast State Park to the south along the coast. The Guerneville BSA is surrounded by a large area of undisturbed natural habitat, including woodland habitat in the southeastern portion of the BSA. Overall, this area represents important natural habitat for a wide range of species and supports genetic connectivity and movement along much of the northern California coast, including into the Mendocino National Forest. None of the other ten BSAs are mapped in an Essential Connectivity Area or Natural Landscape Block. The Glen Ellen BSA lies outside a Natural Landscape Block, the Sonoma Valley Regional Park, approximately 0.2 mile south of the site.

There is potential for movement from local waterways, including the Russian River and Fife Creek in the Guerneville BSA, the Petaluma River and Lichau Creek in the Penngrove BSA, Wood Creek in the Geyserville BSA, Mark West Creek in the Larkfield BSA, Sonoma Creek in the Agua Caliente BSA, Green Valley Creek in the Forestville BSA, Sonoma Creek and Calabazas Creek in the Glen Ellen BSA, and Atascadero Creek in the Graton BSA. The riparian corridors of these waterways are a significant corridor for wildlife movement in Sonoma County. The areas surrounding the rivers and creek are primarily developed areas, including urban residential, commercial, and industrial development. Furthermore, most wildlife species that would utilize such connections are likely urban, disturbance tolerant species such as raccoon, skunk, opossum, and black tailed deer.

Developed areas of the BSA where Rezoning Sites would intersect an urban area do not function as essential connectivity areas or as important wildlife corridors due to previous use and disturbance.

## 4.5 Resources Protected by Local Policies and Ordinances

### Protected Trees

The Rezoning Sites fall under the jurisdiction of Sonoma County. The County's General Plan and Municipal Code includes goals, policies, and ordinances intended to protect, preserve, and enhance natural habitats and biological resources to varying degrees. The County Municipal Code requires permitting for tree removal, and some provide additional protection for landmark or heritage trees (Chapter 26D).

Sonoma County Zoning Code Article 88, Section 26-88-010(m) Tree Protection Ordinance requires projects to be designed to minimize the destruction of protected trees that meet size criteria specified in the ordinance. Protected trees of sufficient size and species to require agency permitting may occur within the BSAs, including but not limited to: big leaf maple (*Acer macrophyllum*), black oak, blue oak, coast live oak, interior live oak, madrone, Oracle oak (*Q. morehus*), Oregon oak, redwood, valley oak, and California bay. Additionally, Valley oak is considered a "Protected tree of special significance" (Sec. 25-2).

Chapter 26, Article 67, Valley Oak Habitat Combining District, of the Sonoma County Zoning Code provides for protection and enhancement of oak woodland habitats. Removal of oak trees in this zoning district requires mitigation measures including retention of other oaks, replacement plantings, and an in-lieu fee.

### Riparian Corridors

Riparian corridors are protected by Sonoma County zoning ordinance (Sec 26-64). This zoning code protects County designated streams, including the bed, bank, and an adjacent streamside conservation areas as measured from the top of bank or the outer drip line of the riparian trees.



Specific setbacks are determined based on the affected river or stream and site-specific conditions but generally include a 25 to 200 foot setback.

## 4.6 Santa Rosa Plain Conservation Strategy

The Larkfield BSA, Santa Rosa BSA, and portions of the Penngrove BSA are in the Santa Rosa Plain Conservation Strategy Area (2005). The goal of the Conservation Strategy is to aid in the conservation of listed species and vernal pools by providing local governments and developers a way to obtain authorization for incidental take of federally listed species for development. Species covered under the Conservation Strategy Area include CTS, Burke's goldfields, Sonoma sunshine, Sebastopol meadowfoam, and many-flowered navarretia.

## 5 Impact Analysis and Mitigation Measures

---

The proposed project will identify sites to be added to the County's General Plan Housing Element site inventory to comply with State law and will implement current General Plan Policies and Programs that require the County to identify urban sites near jobs and transit which may appropriately accommodate additional housing. It will also identify appropriate sites on which to place the Workforce Housing Combining Zone, which would allow the development of jobs and/or housing on the same site or within walking distance from one another.

Specifically, project implementation would rezone up to 59 urban sites in designated Urban Service Areas throughout unincorporated Sonoma County for by-right, medium-density housing. The project would add sites to the County's Housing Element site inventory to comply with new inventory requirements in Housing Element law; it would implement current General Plan policies and programs, including Policy HE-2f, to consider a variety of sites for higher-density and affordable housing, and Housing Element programs 11 and 20, which encourage the identification of urban sites near jobs and transit to appropriately accommodate additional housing. The project includes (1) a General Plan Map amendment as necessary to adjust allowable densities on identified sites; (2) a rezone of sites to match new General Plan densities or to add the AH (Affordable Housing) or WH (Workforce Housing) combining zones; and (3) this report to evaluate the potential environmental impacts of the project. The project is intended to facilitate and encourage housing development that would be developed over a 10-year period, with full buildout by 2030.

This impact analysis is based on a review of existing biological conditions within a BSA that represents a significantly larger area than that of each project's impact footprint. The BSAs were designed to support design modifications and provide detail on biological resources in the area surrounding each Proposed Rezone Site. Identification of sensitive resources at this early stage can support avoidance and/or minimization of potential impacts to sensitive biological resources by providing baseline information. We have reported on the acreages of vegetation communities and special status species habitats in the BSAs, but the actual impacts from rezoning would be significantly less than the acres reported for the BSA. Actual impacts to vegetation communities and potential impacts to special status species because of development at the Proposed Rezone Sites and any adjacent staging/mobilization areas will be determined during project development. Impacts to sensitive biological resources are analyzed accordingly and are not considered as permanent or temporary impacts to the entire BSA. Many of the rezone sites occur within previously disturbed or developed areas, but they are adjacent to several natural vegetation communities. Potential for the project to result in significant impacts to special status biological resources is therefore addressed in detail below.

## 5.1 Special-Status Species

The project would have a significant effect on biological resources if it would:

- a) *Have a substantial adverse effect, either directly or through habitat modifications, on any species identified as a candidate, sensitive, or special status species in local or regional plans, policies, or regulations, or by the California Department of Fish and Wildlife or U.S. Fish and Wildlife Service.*

Known to occur or having the potential to occur are 160 special status plants and 62 special status animals in the BSAs or vicinity (Appendix C). Of these, 78 special status plants have the potential to occur in the BSAs, of which 25 are State or federally listed. There are 36 special status animal species with some potential to occur in the BSAs, including 19 federally or State-listed species (see Appendix C).

Development facilitated by the project for higher density housing will include redevelopment of existing urban structures and loss of some undeveloped habitat. Construction related disturbance may also occur at staging areas and access corridors. These activities could result in significant impacts to special status species through injury or mortality from construction activity. Additionally, construction in the immediate vicinity of creeks or streams could result in loss or degradation of aquatic habitat (e.g. by erosion, sedimentation, pollution, or tampering by the public).

Impacts to CRPR 1B.1 or 1B.2 plant species would only be considered significant if the loss of individuals in the Plan Area represented a population-level impact that resulted in a loss of, or risk to the entire regional population. Given the size of the BSAs, quality of habitat, and small impact area for the types of projects proposed (i.e., re-development of Rezoning Sites), there is low potential for impacts on a population level. Impacts to individuals of State and federally listed species, or population-level adverse effects to non-listed species would be considered significant but can be reduced through the design of project elements to avoid special status plants and sensitive vegetation communities. Impacts to federally or State-listed species from ground disturbing activity or vegetation removal would be considered significant under CEQA.

Special status animal species are most likely to occur in native vegetation communities and natural habitats in the BSAs, but many species may use more disturbed areas as upland or foraging habitat and may occur transiently in the BSAs. Impacts to special status animal species could occur if individuals were present in the BSA at the time of construction through direct injury or mortality. Disturbance may also occur because of construction noise and human presence. Development of Rezoning Sites may also decrease available foraging habitat for some special status birds. These impacts would be considered significant under CEQA.

Given that most of the BSAs are in medium or low density residential and rural areas, impacts due to rezoning are expected to be low, but development that would require ground disturbance or vegetation removal have potential to adversely affect special status species wherever they occur in the BSAs. Avoidance and minimization measures can be applied for a variety of species to reduce the potential impact to less than significant. For projects that are not expected to result in any ground disturbance or very small disturbance (e.g., installation of signage, utility improvements that do not involve ground disturbance outside of paved areas, etc.) and no vegetation removal, no mitigation is required. For those projects that will result in ground disturbance through clearing/grading or vegetation trimming or removal (e.g., demolition of existing buildings and redevelopment construction, etc.), a project-specific biological assessment (Mitigation Measure BIO-1) would be required. Additional mitigation would then be required based on the results of the

project-specific biological analysis and may include one or more of the measures outlined below (Mitigation Measures BIO-2 through BIO-12) to reduce the impact to less than significant.

#### *BIO-1 Biological Resources Screening and Assessment*

For projects in the BSAs that would require ground disturbance through clearing/grading or vegetation trimming, the project applicant shall engage a qualified biologist (having the appropriate education and experience level) to perform a preliminary Biological Resources Screening and Assessment to determine whether the project has any potential to impact special status biological resources, inclusive of special status plants and animals, sensitive vegetation communities, jurisdictional waters (including creeks, drainages, streams, ponds, vernal pools, riparian areas and other wetlands), critical habitat, wildlife movement area, or biological resources protected under regional (County) ordinances or an existing Habitat Conservation Plan (HCP) or Natural Community Conservation Plan, including the Santa Rosa Plain Conservation Strategy. If it is determined that the project has no potential to impact biological resources, no further action is required. If the project would have the potential to impact biological resources, prior to construction, a qualified biologist shall conduct a project-specific biological analysis to document the existing biological resources within a project footprint plus a minimum buffer of 500 feet around the project footprint, as is feasible, and to determine the potential impacts to those resources. The project-specific biological analysis shall evaluate the potential for impacts to all biological resources including, but not limited to special status species, nesting birds, wildlife movement, sensitive plant communities, critical habitats, and other resources judged to be sensitive by local, State, and/or federal agencies. If the project would have the potential to impact these resources, the following mitigation measures (Mitigation Measures BIO-2 through BIO-12) shall be incorporated, as applicable, to reduce impacts to a less than significant. Pending the results of the project-specific biological analysis, design alterations, further technical studies (e.g., protocol surveys) and consultations with the USFWS, National Marine Fisheries Service (NMFS), CDFW, and/or other local, State, and federal agencies may be required. Note that specific surveys described in the mitigation measures below may be completed as part of the project-specific biological analysis where suitable habitat is present.

#### *BIO-2 Special Status Plant Species Surveys*

If the project-specific Biological Resources Screening and Assessment (Mitigation Measure BIO-1) determines that there is potential for significant impacts to federally or state-listed plants or regional population level impacts to species with a CRPR of 1B or 2B from project development, a qualified biologist shall complete surveys for special status plants prior to any vegetation removal, grubbing, or other construction activity (including staging and mobilization). The surveys shall be floristic in nature and shall be seasonally timed to coincide with the target species identified in the project-specific biological analysis. All plant surveys shall be conducted by a qualified biologist during the blooming season prior to initial ground disturbance. All special status plant species identified on site shall be mapped onto a site-specific aerial photograph or topographic map with the use of Global Positioning System unit. Surveys shall be conducted in accordance with the most current protocols established by the CDFW, USFWS, and the local jurisdictions if said protocols exist. A report of the survey results shall be submitted to the County, and the CDFW and/or USFWS, as appropriate, for review and/or approval.

#### *BIO-3 Special Status Plant Species Avoidance, Minimization, and Mitigation*

If federally and/or state-listed or CRPR 1B or 2 species are found during special status plant surveys (pursuant to Mitigation Measure BIO-2), and would be directly impacted, or there would be a

population-level impact to non-listed sensitive species, then the project shall be re-designed to avoid impacting those plant species, where feasible. Rare and listed plant occurrences that are not within the immediate disturbance footprint but are located within 50 feet of disturbance limits shall have bright orange protective fencing installed at least 30 feet beyond their extent, or other distance as approved by a qualified biologist, to protect them from harm.

For projects in BSA's located within the Santa Rosa Plain Area, protocol rare plant surveys shall be conducted, and impacts to suitable rare plant habitat mitigated, in accordance with the 2007 USFWS Santa Rosa Plain Programmatic Biological Opinion, as amended in 2020.

#### *BIO-4 Restoration and Monitoring*

Development and/or restoration activities shall be conducted in accordance with a site-specific Habitat Restoration Plan. If federally or state-listed plants or non-listed special status CRPR 1B and 2 plant populations cannot be avoided, and will be impacted by development, all impacts shall be mitigated by the applicant at a ratio not lower than 1:1 and to be determined by the County (in coordination with CDFW and USFWS as and if applicable) for each species as a component of habitat restoration. A qualified biologist shall prepare and submit a restoration plan to the County for review and approval. (Note: if a federally and/or state-listed plant species will be impacted, the restoration plan shall be submitted to the USFWS and/or CDFW for review, and federal and/or state take authorization may be required by these agencies). The restoration plan shall include, at a minimum, the following components:

1. Description of the project/impact site (i.e., location, responsible parties, areas to be impacted by habitat type)
2. Goal(s) of the compensatory mitigation project (type[s] and area[s] of habitat to be established, restored, enhanced, and/or preserved; specific functions and values of habitat type[s] to be established, restored, enhanced, and/or preserved)
3. Description of the proposed compensatory mitigation site (location and size, ownership status, existing functions, and values)
4. Implementation plan for the compensatory mitigation site (rationale for expecting implementation success, responsible parties, schedule, site preparation, planting plan)
5. Maintenance activities during the monitoring period, including weed removal as appropriate (activities, responsible parties, schedule)
6. Monitoring plan for the compensatory mitigation site, including no less than quarterly monitoring for the first year (performance standards, target functions and values, target acreages to be established, restored, enhanced, and/or preserved, annual monitoring reports)
7. Success criteria based on the goals and measurable objectives; said criteria to be, at a minimum, at least 80 percent survival of container plants and 30 percent relative cover by vegetation type or other industry standards as determined by a qualified restoration specialist
8. An adaptive management program and remedial measures to address any shortcomings in meeting success criteria
9. Notification of completion of compensatory mitigation and agency confirmation
10. Contingency measures (initiating procedures, alternative locations for contingency compensatory mitigation, funding mechanism)

*BIO-5 Endangered/Threatened Species Habitat Assessments and Protocol Surveys*

Specific habitat assessments and survey protocols are established for several federally- and state-endangered or threatened species. If the results of the project-specific biological analysis determine that suitable habitat may be present for any such species, protocol habitat assessments/surveys shall be completed in accordance with CDFW, NMFS, and/or USFWS protocols prior to issuance of any construction permits. If projects are located within the Santa Rosa Plain Area, surveys shall be conducted for CTS in accordance with the Santa Rosa Plain Conservation Strategy (2005). If through consultation with the CDFW, NMFS, and/or USFWS it is determined that protocol habitat assessments/surveys are not required, the applicant shall complete and document this consultation and submit it to the County prior to issuance of any construction permits. Each protocol has different survey and timing requirements. The applicant shall be responsible for ensuring they understand the protocol requirements and shall hire a qualified biologist to conduct protocol surveys.

*BIO-6 Endangered/Threatened Animal Species Avoidance and Minimization*

The following measures shall be applied to aquatic and/or terrestrial animal species as determined by the project-specific Biological Resources Screening and Assessment required under Mitigation Measure BIO-1.

1. Ground disturbance shall be limited to the minimum necessary to complete the project. A qualified biologist shall flag the project limits of disturbance. Areas of special biological concern within or adjacent to the limits of disturbance shall have highly visible orange construction fencing installed between said area and the limits of disturbance.
2. All projects occurring within/adjacent to aquatic habitats (including riparian habitats and wetlands) shall be completed between April 1 and October 31, if feasible, to avoid impacts to sensitive aquatic species. Any work outside these dates would require project-specific approval from the County and may be subject to regulatory agency approval.
3. All projects occurring within or adjacent to sensitive habitats that may support federally and/or state-listed endangered/threatened species shall have a CDFW- and/or USFWS-approved biologist present during all initial ground disturbing/vegetation clearing activities. Once initial ground disturbing/vegetation clearing activities have been completed, said biologist shall conduct daily pre-activity clearance surveys for endangered/threatened species. Alternatively, and upon approval of the CDFW, NMFS, and/or USFWS, said biologist may conduct site inspections at a minimum of once per week to ensure all prescribed avoidance and minimization measures are fully implemented.
4. No endangered/threatened species shall be captured and relocated without express permission from the CDFW, NMFS, and/or USFWS.
5. If at any time during project construction an endangered/threatened species enters the construction site or otherwise may be impacted by the project, all project activities shall cease. A CDFW/USFWS-approved biologist shall document the occurrence and consult with the CDFW and USFWS, as appropriate, to determine whether it was safe for project activities to resume.
6. For all projects occurring in areas where endangered/ threatened species may be present and are at risk of entering the project site during construction, the applicant shall install exclusion fencing along the project boundaries prior to start of construction (including staging and mobilization). The placement of the fence shall be at the discretion of the CDFW/USFWS-

approved biologist. This fence shall consist of solid silt fencing placed at a minimum of three feet above grade and two feet below grade and shall be attached to wooden stakes placed at intervals of not more than five feet. The applicant shall inspect the fence weekly and following rain events and high wind events and shall be maintained in good working condition until all construction activities are complete.

7. All vehicle maintenance/fueling/staging shall occur not less than 100 feet from any riparian habitat or water body, including seasonal wetland features. Suitable containment procedures shall be implemented to prevent spills. A minimum of one spill kit shall be available at each work location near riparian habitat or water bodies.
8. No equipment shall be permitted to enter wetted portions of any affected drainage channel.
9. If project activities could degrade water quality, water quality sampling shall be implemented to identify the pre-project baseline, and to monitor during construction for comparison to the baseline.
10. If water is to be diverted around work sites, the applicant shall submit a diversion plan (depending upon the species that may be present) to the CDFW, RWQCB, USFWS, and/or NMFS for their review and approval prior to the start of any construction activities (including staging and mobilization). If pumps are used, all intakes shall be completely screened with wire mesh not larger than five millimeters to prevent animals from entering the pump system.
11. At the end of each workday, excavations shall be secured with cover or a ramp provided to prevent wildlife entrapment.
12. All trenches, pipes, culverts, or similar structures shall be inspected for animals prior to burying, capping, moving, or filling.
13. The CDFW/USFWS-approved biologist shall remove invasive aquatic species such as bullfrogs and crayfish from suitable aquatic habitat whenever observed and shall dispatch them in a humane manner and dispose of properly.
14. Considering the potential for projects to impact federally and State-listed species and their habitat, the applicant shall contact the CDFW and USFWS to identify mitigation banks within Sonoma County during project development. If the results of the project-specific biological analysis (Mitigation Measure BIO-1) determine that impacts to federally and state threatened or endangered species habitat are expected, the applicant shall explore species-appropriate mitigation bank(s) servicing the region for purchase of mitigation credits. If projects are located within the Santa Rosa Plain Area, mitigation for impacts to CTS shall be implemented in accordance with the Santa Rosa Plain Conservation Strategy (2005).
15. For projects occurring in the Petaluma BSA (PET-1 through PET-4), prior to grading and construction in natural areas of containing suitable upland habitat, a qualified biologist shall conduct a preconstruction survey for CTS. The survey should include a transect survey over the entire project disturbance footprint (including access and staging areas), and mapping of burrows that are potentially suitable for salamander occupancy. If any CTS are detected, no work shall be conducted until the individual leaves the site of their own accord, unless federal and state "take" authorization has been issued for CTS relocation. Typical preconstruction survey procedures, such as burrow scoping and burrow collapse, cannot be conducted without federal and state permits. If any life stage of CTS is found within the survey area, the applicant shall consult with the USFWS and CDFW to determine the appropriate course of action to comply with the FESA and CESA, if permits are not already in place at the time of construction.

*BIO-7 Non-Listed Special Status Animal Species Avoidance and Minimization*

The project-specific Biological Resources Screening and Assessment (Mitigation Measure BIO-1) shall identify some or all the below measures that will be required and applicable to the individual project:

1. For non-listed special status terrestrial amphibians and reptiles, a qualified biologist shall complete coverboard surveys within 14 days of the start of construction. The coverboards shall be at least four feet by four feet and constructed of untreated plywood placed flat on the ground as determined by the project-specific biological assessment (pursuant Mitigation Measure BIO-1). The qualified biologist shall check the coverboards once per week for each week after placement up until the start of vegetation removal. The biologist shall capture all non-listed special status and common animals found under the coverboards and shall place them in five-gallon buckets for transportation to relocation sites. The qualified biologist shall review all relocation sites and those sites shall consist of suitable habitat. Relocation sites shall be as close to the capture site as possible but far enough away to ensure the animal(s) is not harmed by project construction. Relocation shall occur on the same day as capture. The biologist shall submit CNDDDB Field Survey Forms to the CFDW for all special status animal species observed.
2. Prior to construction, a qualified biologist shall conduct a survey of existing buildings to determine if bats are present. The survey shall be conducted during the non-breeding season (November through March). The biologist shall have access to all structures and interior attics, as needed. If a colony of bats is found roosting in any structure, further surveys shall be conducted sufficient to determine the species present and the type of roost (day, night, maternity, etc.).
3. If bats are roosting in the building during the daytime but are not part of an active maternity colony, then exclusion measures must include one-way valves that allow bats to get out but are designed so that the bats may not re-enter the structure. Maternal bat colonies shall not be disturbed.
4. A qualified biologist shall conduct pre-construction clearance surveys within 14 days of the start of construction (including staging and mobilization). The surveys shall cover the entire disturbance footprint plus a minimum 200-foot buffer, if feasible, and shall identify all special status animal species that may occur on-site. All non-listed special status species shall be relocated from the site either through direct capture or through passive exclusion. The biologist shall submit a report of the pre-construction survey to the County for their review and approval prior to the start of construction.
5. A qualified biologist shall be present during all initial ground-disturbing activities, including vegetation removal to recover special status animal species unearthed by construction activities.
6. Project activities shall be restricted to daylight hours.
7. Upon completion of the project, a qualified biologist shall prepare a Final Compliance Report documenting all compliance activities implemented for the project, including the pre-construction survey results. The report shall be submitted to the County within 30 days of completion of the project.
8. If special status bat species may be present and impacted by the project, a qualified biologist shall conduct, within 30 days of the start of construction, presence/absence surveys for special status bats in consultation with the CDFW where suitable roosting habitat is present. Surveys



shall be conducted using acoustic detectors and by searching tree cavities, crevices, and other areas where bats may roost. If active roosts are located, exclusion devices such as netting shall be installed to discourage bats from occupying the site. If a qualified biologist determines a roost is used by a large number of bats (large hibernaculum), bat boxes shall be installed near the project site. The number of bat boxes installed will depend on the size of the hibernaculum and shall be determined through consultation with CDFW. If a maternity colony has become established, all construction activities shall be postponed within a 500-foot buffer around the maternity colony until it is determined by a qualified biologist that the young have dispersed. Once it has been determined that the roost is clear of bats, the roost shall be removed immediately.

*BIO-8 Western Pond Turtle Avoidance and Minimization*

For projects located in the Penngrove BSA (PEN-1 through PEN-9), a qualified biologist shall conduct pre-construction clearance surveys for western pond turtle within 14 days prior to the start of construction (including staging and mobilization) in areas of suitable habitat. The biologist shall flag limits of disturbance for each construction phase. Areas of special biological concern within or adjacent to the limits of disturbance should have highly visible orange construction fencing installed between said area and the limits of disturbance. If western pond turtles are observed they shall be allowed to leave the site on their own.

*BIO-9 American Badger Avoidance and Minimization*

For projects located in the Petaluma BSA (PET-1 through PET-4), a qualified biologist shall conduct surveys of the grassland habitat on-site to identify any American badger burrows/dens. These surveys shall be conducted not more than 14 days prior to the start of construction. Impacts to active badger dens shall be avoided by establishing exclusion zones around all active badger dens, within which construction related activities shall be prohibited until denning activities are complete or the den is abandoned. A qualified biologist shall monitor each den once per week in order to track the status of the den and to determine when a den area has been cleared for construction.

*BIO-10 Pre-construction Surveys for Nesting Birds for Construction Occurring within Nesting Season*

For projects that require the removal of trees or vegetation, construction activities shall occur outside of the nesting season wherever feasible (September 16 to January 31), and no mitigation activity is required. If construction activities must occur during the nesting season (February 1 to September 15), a qualified biologist shall conduct surveys for nesting birds covered by the CGFC no more than 14 days prior to vegetation removal. The surveys shall include the entire disturbance area plus a 200-foot buffer around the site as feasible. If active nests are located, all construction work shall be conducted outside a buffer zone from the nest to be determined by the qualified biologist. The buffer shall be a minimum of 50 feet for non-raptor bird species and at least 150 feet for raptor species. Larger buffers may be required depending upon the status of the nest and the construction activities occurring in the vicinity of the nest. The buffer area(s) shall be closed to all construction personnel and equipment until the adults and young are no longer reliant on the nest site. A qualified biologist shall confirm that breeding/nesting is completed and young have fledged the nest prior to removal of the buffer. The biologist shall submit a report of these preconstruction nesting bird surveys to the County to document compliance within 30 days of its completion.

*BIO-11 Worker Environmental Awareness Program*

If potential impacts to special status species are identified in the project-specific Biological Resources Screening and Assessment (Mitigation Measure BIO-1), prior to initiation of construction activities (including staging and mobilization), all personnel associated with project construction shall attend Worker Environmental Awareness Program training, conducted by a qualified biologist, to aid workers in recognizing special status resources that may occur in the BSAs for the project. The specifics of this program shall include identification of the sensitive species and habitats, a description of the regulatory status and general ecological characteristics of sensitive resources, and review of the limits of construction and mitigation measures required to reduce impacts to biological resources within the work area. A fact sheet conveying this information shall also be prepared for distribution to all contractors, their employers, and other personnel involved with construction of projects. All employees shall sign a form documenting provided by the trainer indicating they have attended the Worker Environmental Awareness Program and understand the information presented to them. The form shall be submitted to the County to document compliance.

*BIO-12 Invasive Weed Prevention and Management Program*

For those projects where activity would occur within or adjacent to sensitive habitats, as determined by the project-specific Biological Resources Screening and Assessment (Mitigation Measure BIO-1), prior to start of construction a qualified biologist shall develop an Invasive Weed Prevention and Management Plan to prevent invasion of native habitat by non-native plant species. A list of target species shall be included, along with measures for early detection and eradication. All disturbed areas shall be hydroseeded with a mix of locally native species upon completion of work in those areas. In areas where construction is ongoing, hydroseeding shall occur where no construction activities have occurred within six weeks since ground disturbing activities ceased. If exotic species invade these areas prior to hydroseeding, weed removal shall occur in consultation with a qualified biologist and in accordance with the restoration plan. Landscape species shall not include noxious, invasive, and/or non-native plant species that are recognized on the Federal Noxious Weed List, California Noxious Weeds List, and/or California Invasive Plant Council Moderate and High Risk Lists.

## 5.2 Sensitive Plant Communities

The project would have a significant effect on biological resources if it would:

- b) Have a substantial adverse impact on any riparian habitat or other sensitive natural community identified in local or regional plans, policies, regulations or by the California Department of Fish and Wildlife or US Fish and Wildlife Service.*

Sensitive natural communities known to occur within the BSA which may be impacted by development facilitated by rezoning include riparian and vernal pool habitat and riparian corridors protected by the Sonoma County zoning ordinance (Section 26-65). Other natural communities included in the California Sensitive Natural Communities List are also likely to be present in the BSAs but have not been mapped on a broad scale. Additionally, federally designated critical habitat units for Steelhead, coho salmon, and CTS occur in the BSAs and may be affected by the project. Direct impacts to sensitive habitats and critical habitats could occur through direct conversion of habitats to development. Projects facilitated by rezoning with potential to adversely affect sensitive or critical habitat are those projects that would include ground disturbance or vegetation removal

adjacent to critical habitat in the Guerneville, Forestville, Larkfield, Graton, Santa Rosa, Penngrove, Petaluma, and Glen Ellen BSAs. Development facilitated by the project would be required to comply with existing County standards and processes, including Section 26-65 protecting riparian corridors. However, significant indirect impacts could also occur through the establishment of non-native invasive species, but implementation of the mitigation measures below would reduce impacts to less than significant. Therefore, impacts would be less than significant with mitigation incorporated.

#### *BIO-13 Sensitive Natural Community Avoidance*

If sensitive natural communities are identified through the project-specific Biological Resources Screening and Assessment (Mitigation Measure BIO-1), the project shall be designed to avoid those communities to the maximum extent possible and all project elements associated with development shall be situated outside of sensitive habitats. Bright orange protective fencing installed at least 30 feet beyond the extent of the sensitive natural community during construction, or other distance as approved by a qualified biologist, to protect them from harm.

#### *BIO-14 Restoration for Impacts to Sensitive Natural Communities*

Impacts to sensitive natural communities (including riparian areas and waters of the state or waters of the U.S. under the jurisdiction of the CDFW, USFWS or RWQCB) shall be mitigated through the funding of the acquisition and in-perpetuity management of similar habitat. The applicant shall provide funding and management of off-site mitigation lands through purchase of credits from an existing, approved mitigation bank or land purchased by the County and placed into a conservation easement or other covenant restricting development (e.g., deed restriction). Internal mitigation lands (internal to the Rezoning Sites), or in lieu funding sufficient to acquire lands, shall provide habitat at a minimum 1:1 ratio for impacted lands, comparable to habitat to be impacted by individual project activity. The applicant shall submit documentation of mitigation funds to the County.

1. **Restoration and Monitoring.** If sensitive natural communities cannot be avoided and will be impacted by future projects, a compensatory mitigation program shall be implemented by the applicant in accordance with Mitigation Measure BIO-4 and the measures set forth by the regulatory agencies during the permitting process. All temporary impacts to sensitive natural communities shall be fully restored to natural condition.
2. **Sudden Oak Death.** The applicant shall inspect all nursery plants used in restoration for sudden oak death. Vegetation debris shall be disposed of properly and vehicles and equipment shall be free of soil and vegetation debris before entering natural habitats. Pruning tools shall be sanitized.

### 5.3 Jurisdictional Waters and Wetlands

The project would have a significant effect on biological resources if it would:

- c) *Have a substantial adverse effect on state or federally protected wetlands (including, but not limited to, marsh, vernal pool, coastal, etc.) through direct removal, filling, hydrological interruption, or other means.*

Wetlands and waters cross many of the BSAs and may be affected by implementation of projects facilitated by rezoning that would occur within the limits of, or adjacent to, jurisdictional waters. Rezoning projects are not expected to directly impact jurisdictional features but may include runoff

from construction sites or unintentional spills. There are eight creeks located within the BSAs, Sonoma Creek, Atascadero Creek, and Mark West Creek, Lichau Creek, Fife Creek, Sonoma Creek, and Calabazas Creek. In addition, vernal pool habitat was mapped at the Penngrove and Santa Rosa BSAs. These wetlands and non-wetland waters may be subject to USACE jurisdiction under the CWA, RWQCB jurisdiction under the CWA and Porter-Cologne, and CDFW jurisdiction under the CFGC. Because of the programmatic nature of rezoning, a precise, project-level analysis of the specific impacts associated with individual projects on potential wetlands is not possible at this time and site-specific analysis is needed to verify if wetlands are present. If projects have the potential to impact wetlands, the projects shall either be designed to avoid impacts to federal and State waters or shall be subject to measure BIO-15. If, based on the results of the jurisdictional delineation, it is determined that project activity would result in either direct or indirect impacts to waters of the state or waters of the U.S., then Mitigation Measure BIO-16 shall be implemented to ensure no net loss of wetlands functions and ensure impacts to waters of the state or waters of the U.S. are less than significant. Impacts are less than significant with mitigation incorporated.

#### *BIO-15 Jurisdictional Delineation*

If potentially jurisdictional wetlands are identified by the project-specific Biological Resources Screening and Assessment (Mitigation Measure BIO-1), a qualified biologist shall complete a jurisdictional delineation. The jurisdictional delineation shall determine the extent of the jurisdiction for CDFW, USACE, and/or RWQCB, and shall be conducted in accordance with the requirement set forth by each agency. The result shall be a preliminary jurisdictional delineation report that shall be submitted to the County, USACE, RWQCB, and CDFW, as appropriate, for review and approval. Jurisdictional areas shall be avoided to the maximum extent possible. If jurisdictional areas are expected to be impacted, then the RWQCB would require a Waste Discharge Requirement permit and/or Section 401 Water Quality Certification (depending upon whether the feature falls under federal jurisdiction). If CDFW asserts its jurisdictional authority, then a Lake or Streambed Alteration Agreement pursuant to Section 1600 et seq. of the CFGC would also be required prior to construction within the areas of CDFW jurisdiction. If the USACE asserts its authority, then a permit pursuant to Section 404 of the CWA would be required. Furthermore, a compensatory mitigation program shall be implemented by the applicant in accordance with Mitigation Measure BIO-4 and the measures set forth by the regulatory agencies during the permitting process. Compensatory mitigations for all permanent impacts to waters of the U.S. and waters of the state shall be completed at a ratio as required in applicable permits. All temporary impacts to waters of the U.S. and waters of the state shall be fully restored to natural condition.

#### *BIO-16 General Avoidance and Minimization*

Projects shall be designed to avoid potential jurisdictional features identified in jurisdictional delineation reports. Projects that may impact jurisdictional features shall provide the County with a report detailing how all identified jurisdictional features will be avoided, including groundwater draw down.

1. Any material/spoils generated from project activities shall be located away from jurisdictional areas or special-status habitat and protected from storm water run-off using temporary perimeter sediment barriers such as berms, silt fences, fiber rolls (non- monofilament), covers, sand/gravel bags, and straw bale barriers, as appropriate.
2. Materials shall be stored on impervious surfaces or plastic ground covers to prevent any spills or leakage from contaminating the ground and generally at least 50 feet from the top of bank.

3. Any spillage of material will be stopped if it can be done safely. The contaminated area will be cleaned, and any contaminated materials properly disposed. For all spills, the project foreman or designated environmental representative will be notified.

## 5.4 Wildlife Movement

The project would have a significant effect on biological resources if it would:

- d) *Interfere substantially with the movement of any resident or migratory fish or wildlife species or with established resident or migratory wildlife corridors or impede the use of wildlife nursery sites.*

The Guerneville BSA is mapped in an Essential Connectivity Area connecting two natural land blocks; however, the project and ensuing development projects would occur in the community of Guerneville in a largely developed area that does not function as a corridor for movement. The remaining BSAs are also located in rural/residential areas with varying degrees of existing development. Additionally, redevelopment under rezoning would not affect the function of creeks and riparian areas in the BSAs as local corridors for wildlife movement; therefore, impacts would be less than significant.

## 5.5 Local Policies and Ordinances

The project would have a significant effect on biological resources if it would:

- e) *Conflict with any local policies or ordinances protecting biological resources, such as a tree preservation policy or ordinance*

The Proposed Rezone Sites fall under the jurisdiction of Sonoma County, which provides protection for biological resources through the implementation of its General Plan and Zoning Code.

The Sonoma County General Plan 2020 (Sonoma County 2008) includes policies to guide decisions on future growth, development, and conservation of resources through 2020. This includes the “Open Space and Resource Conservation Elements” which aims to preserve the natural and scenic resources.

The Sonoma County Zoning Code Chapter 26D, *Heritage or Landmark Trees*, and Sonoma County Zoning Code Article 88, Section 26-88-010(m), *Tree Protection Ordinance*, provides for the protection of heritage and landmark trees. Article 67, *Valley Oak Habitat Combining District*, of the Sonoma County Zoning Code provides protection for oak woodland habitats, and Article 65, *Riparian Corridor Combining Zone*, of the Sonoma County Zoning Code provides protection for riparian corridors.

Trees to be removed have not yet been identified because individual projects have not been developed yet; however, development of rezone sites would potentially require some tree removal. Additionally, some loss of habitat and biological resources is expected. Development of rezoned sites would be required to comply with these goals policies and measures, including via the application for tree removal permits and compliance with associated requirement (e.g., tree replacement) where applicable. Pursuant to compliance with these regulations, impacts would be less than significant.

## 5.6 Adopted or Approved Plans

The project would have a significant effect on biological resources if it would:

- f) *Conflict with the provisions of an adopted Habitat Conservation Plan, Natural Conservation Community Plan, or other approved local, regional, or state habitat conservation plan.*

The Larkfield BSA, Santa Rosa BSA, and portions of the Penngrove BSA are within the Santa Rosa Plain Conservation Strategy Area (2005). The Larkfield BSA is located outside the Windsor Urban growth boundary, to the south. The Santa Rosa BSA is located at the southern end of the Santa Rosa urban growth boundary, with some edges outside the boundary. The western half of the Penngrove BSA is within the Conservation Strategy Area outside of the Cotati urban growth boundary, to the south. The Conservation Strategy urban growth boundaries were designed to limit development in natural habitats and focus future growth within previously developed areas. The Conservation Strategy does allow for some development outside of the urban growth boundaries as long as it doesn't change land use appreciably, and impacts are adequately mitigated. Because the parcels proposed for rezoning are small and the majority of the BSAs will remain under the current agricultural, residential, commercial, and industrial zoning, rezoning is not likely to change land use appreciably and could be sufficiently mitigated in accordance with the Sonoma County General Plan. The Santa Rosa Plain Conservation Strategy has not been finalized or implemented as of the writing of this report; therefore, impacts from the potential project would be less than significant with mitigation.

The USFWS has issued a programmatic Biological Opinion (BO) to the USACE for projects that may affect listed species on the Santa Rosa Plain (1998) and updated it in 2007 and 2020. In 2016 USFWS issued the Santa Rosa Plain Recovery Plan to provide a framework for the recovery of CTS, Burke's goldfields, Sonoma sunshine, and Sebastopol meadowfoam (USFWS 2016). If projects resulting from rezoning would affect listed species in the Santa Rosa Plain there is potential for conflict with these plans and conservation strategies, which would be considered significant under CEQA. With implementation of mitigation measure BIO-17, impacts would be less than significant with mitigation.

### *BIO-17 Consistency with the Santa Rosa Plain Conservation Strategy*

For sites SAN-1 through SAN-10, the Biological Resources Screening and Assessment (Mitigation Measure BIO-1) shall assess projects for impacts to listed species included in the Santa Rosa Plain Conservation Strategy. Impacts to these species should be evaluated and mitigated per the mitigation measures included in Chapter 5 of the Conservation Strategy.

## 6 Limitations, Assumptions, and Use Reliance

---

This Biological Resources Assessment has been performed in accordance with professionally accepted biological investigation practices conducted at this time and in this geographic area. The biological investigation is limited by the scope of work performed. The findings and opinions conveyed in this report are based on findings derived from review of CNDDDB RareFind5 and specified historical and literature sources. Standard data sources relied upon during the completion of this report, such as the CNDDDB, may vary as to accuracy and completeness. In particular, the CNDDDB is compiled from research and observations reported to CDFW that may or may not have been the result of comprehensive or site-specific field surveys. Although Rincon believes the data sources are reasonably reliable, Rincon cannot and does not guarantee the authenticity or reliability of the data sources it has used. Additionally, pursuant to our contract, the data sources reviewed included only those that are practically reviewable without the need for extraordinary research and analysis.

## 7 References

---

- Baldwin, B.G. (Ed.), D.H. Goldman (Ed.), D. J. Keil (Ed.), R. Patterson (Ed.), T. J. Rosatti (Ed.), D. H. Wilken (Ed.). 2012. The Jepson Manual: Vascular Plants of California, Second Edition, Thoroughly Revised and Expanded. University of California Press. Berkeley, California. [online] <http://ucjeps.berkeley.edu/eflora/> Accessed April 2020 and October 2022.
- Calflora. 2022. Information on wild California plants for conservation, education, and appreciation. Berkeley, CA. [online]: [www.calflora.org](http://www.calflora.org). Accessed April 2020 and October 2022.
- California Department of Fish and Wildlife (CDFW). 2022. Special Animals List. Biogeographic Data Branch, California Natural Diversity Database. August 2019 and October 2022.
- \_\_\_\_\_. 2022a. California Natural Diversity Database, Rarefind V. [online] <https://wildlife.ca.gov/data/cnddb/maps-and-data> Accessed March 2020 and October 2022
- \_\_\_\_\_. 2022b. Biogeographic Information and Observation System. [database] [www.wildlife.ca.gov/data/BIOS](http://www.wildlife.ca.gov/data/BIOS) Accessed April 2020 and October 2022.
- \_\_\_\_\_. 2022c. Special Vascular Plants, Bryophytes, and Lichens List. Biogeographic Data Branch, California Natural Diversity Database. January 2020 and October 2022.
- California Native Plant Society (CNPS). 2022. Inventory of Rare and Endangered Plants. V.7-08c-Interim 8-22-02. [online] [www.rareplants.cnps.org](http://www.rareplants.cnps.org) Accessed March 2020 and October 2022.
- Google Earth Pro (Google Earth). 2022. Version 7.3.2.5776 (64-bit). [online] <https://www.google.com/earth/> Accessed April 2020 and October 2022.
- Holland, Robert F. 1986. Preliminary Descriptions of the Terrestrial Natural Communities of California. California Department of Fish and Wildlife, Nongame Heritage Program. 156 pgs.
- Mayer, K. E. and W. F. Laudenslayer. 1988. A Guide to Wildlife Habitats of California. State of California, Resources Agency, Department of Fish and Game Sacramento, CA. 166 pp.
- National Oceanic and Atmospheric Administration. 2022. Western U.S. Climate Historical Summaries, Weather Station: Sonoma, California (048351). [online] <https://wrcc.dri.edu/cgi-bin/cliMAIN.pl?ca8351>. Accessed April 2020.
- \_\_\_\_\_. Climate Sonoma - California and Weather averages Sonoma ([usclimatedata.com](http://usclimatedata.com)) Accessed October 2022.
- National Marine Fisheries Service (NMFS). 2006. Federal Register. 50 CFR Parts 223 and 224. Endangered and Threatened Species: Final Listing Determinations for 10 Distinct Population Segments of West Coast Steelhead; Final Rule.
- \_\_\_\_\_. 2009. Federal Register. 50 CFR Part 226. Endangered and Threatened Wildlife and Plants: Final Rulemaking to Designate Critical Habitat for the Threatened Southern Distinct Population Segment of North American Green Sturgeon; Final Rule.
- Petaluma Zoning Code, Tree Preservation, Chapter 17. [online] <https://petaluma.municipal.codes/ZoningOrds/17>. Accessed March 2020.



- Santa Rosa City Code, Trees, Chapter 71.24. 1990. 17-24.050 Permit category II—Tree alteration, removal or relocation on property proposed for development—Requirements (Ord. 2858 § 1, 1990). [online] [https://qcode.us/codes/santarosa/?view=desktop&topic=17-17\\_24-iv-17\\_24\\_050](https://qcode.us/codes/santarosa/?view=desktop&topic=17-17_24-iv-17_24_050) Accessed April 2020
- Sawyer, J. O., T. Keeler-Wolf, and J.M. Evens. 2009. A Manual of California Vegetation, Second Edition. California Native Plant Society, Sacramento, California. [online] <http://vegetation.cnps.org/> Accessed April 2020
- Sonoma, County of. 2008. General Plan 2020. [online] <https://sonomacounty.ca.gov/PRMD/Long-Range-Plans/General-Plan/>. Accessed March 2020.
- \_\_\_\_\_. 2018. Sonoma County Water Agency, Sonoma County Agricultural Preservation and Open Space District, Sonoma County Vegetation Mapping and LiDAR Program.
- United States Department of Agriculture (USDA), Natural Resources Conservation Service (NRCS). 2019a. Web Soil Survey. Soil Survey Area: Sonoma County, California. Soil Survey Data: Version 8, March 9, 2019. [online] <https://websoilsurvey.sc.egov.usda.gov/App/HomePage.htm>. Accessed March 2020.
- \_\_\_\_\_. 2019b. Lists of Hydric Soils. National Cooperative Soil Survey, U.S. Department of Agriculture. [online] <https://www.nrcs.usda.gov/wps/portal/nrcs/main/soils/use/hydric/>. Accessed April 2020
- United States Geologic Survey (USGS). 2022. National Hydrography Dataset (NHD) Accessed through the National Map. <https://viewer.nationalmap.gov/advanced-viewer/> Accessed March 2020 and October 2022.
- United States Fish and Wildlife Service (USFWS). 1973. The Endangered Species Act of 1973, as amended (16 U.S.C 1531 et seq.).
- \_\_\_\_\_. 2000. Guidelines for Conducting and Reporting Botanical Inventories for Federally Listed, Proposed, and Candidate Plants. January 2000.
- \_\_\_\_\_. 2010. Federal Register. 50 CFR Part 17. Endangered and Threatened Wildlife and Plants: Revised Designation of Critical Habitat for California Red-Legged Frog; Final Rule.
- \_\_\_\_\_. 2011a. Federal Register. 50 CFR Part 17. Endangered and Threatened Wildlife and Plants; Final Designation of Critical Habitat for the Marbled Murrelet; Final Rule.
- \_\_\_\_\_. 2011b. Federal Register. 50 CFR Part 17. Endangered and Threatened Wildlife and Plants; Designation of Critical Habitat for the Sonoma County Distinct Population Segment of the California Tiger Salamander.
- \_\_\_\_\_. 2012. Federal Register. 50 CFR Part 17. Endangered and Threatened Wildlife and Plants; Designation of Revised Critical Habitat for the Northern Spotted Owl; Final Rule.
- \_\_\_\_\_. 2016. Recovery Plan for the Santa Rosa Plain: *Blennosperma bakeri* (Sonoma sunshine); *Lasthenia burkei* (Burke's goldfields); *Limnanthes vinculans* (Sebastopol meadowfoam); California Tiger Salamander Sonoma County Distinct Population Segment (*Ambystoma californiense*). U.S. Fish and Wildlife Service, Pacific Southwest Region, Sacramento, California. vi + 128 pp.
- \_\_\_\_\_. 2020a. Information for Planning and Consultation online project planning tool. [online] <https://ecos.fws.gov/ipac/> Accessed March 2020

- \_\_\_\_\_. 2022a. Critical Habitat Portal. Last Updated: October 4, 2022 [online]  
<https://ecos.fws.gov/ecp/report/table/critical-habitat.html> Accessed April 2020 and  
October 2022.
- \_\_\_\_\_. 2022b. National Wetlands Inventory. <https://www.fws.gov/wetlands/Data/Mapper.html>  
Accessed March 2020 and October 2022.

## 8 List of Preparers

---

### **Rincon Consultants, Inc.**

#### *Primary Author*

- Samantha Kehr, Senior Biologist

#### *Technical Review*

- Craig Lawrence, Senior Biologist
- Sherri Miller, Principal Biologist

#### *Graphics*

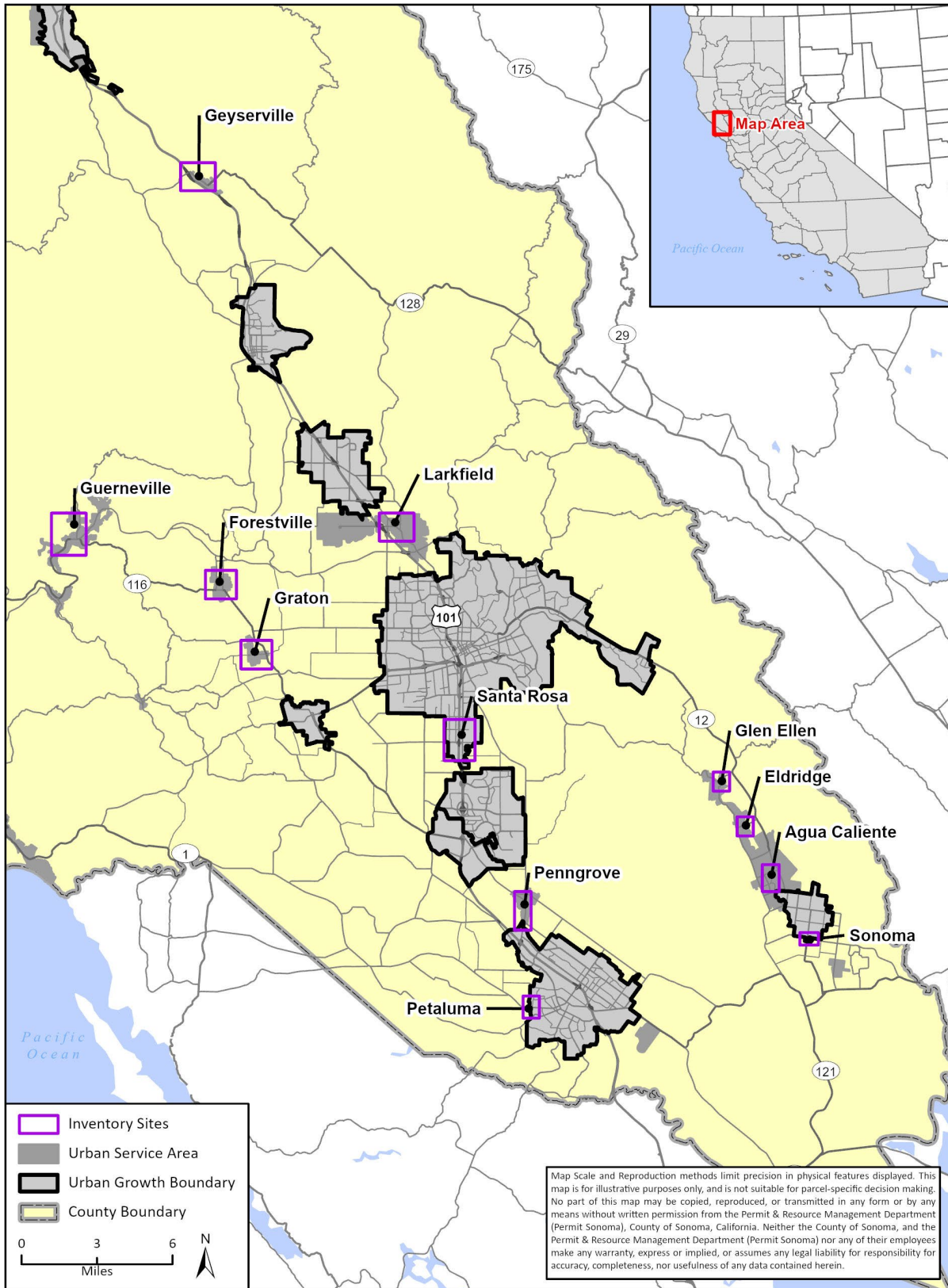
- Jon Montgomery, GIS Specialist

# Appendix A

---

Figures

**Figure 1 Regional Location**



Source: Modified from data obtained with permission from the County of Sonoma, Permit & Resource Management Department (Permit Sonoma), 2022. Data and/or analysis depicted may be altered from the original Permit Sonoma dataset source therefore not representative of Permit Sonoma data; Esri.

Figure 2a Biological Study Area – Agua Caliente



Imagery provided by Microsoft Bing and its licensors © 2022.

Figure 2b Biological Study Area – Forestville



Imagery provided by Microsoft Bing and its licensors © 2022.

Figure 2c Biological Study Area – Geyserville





Figure 2d Biological Study Area – Glen Ellen



Figure 2e Biological Study Area – Graton



Figure 2f Biological Study Area – Guerneville

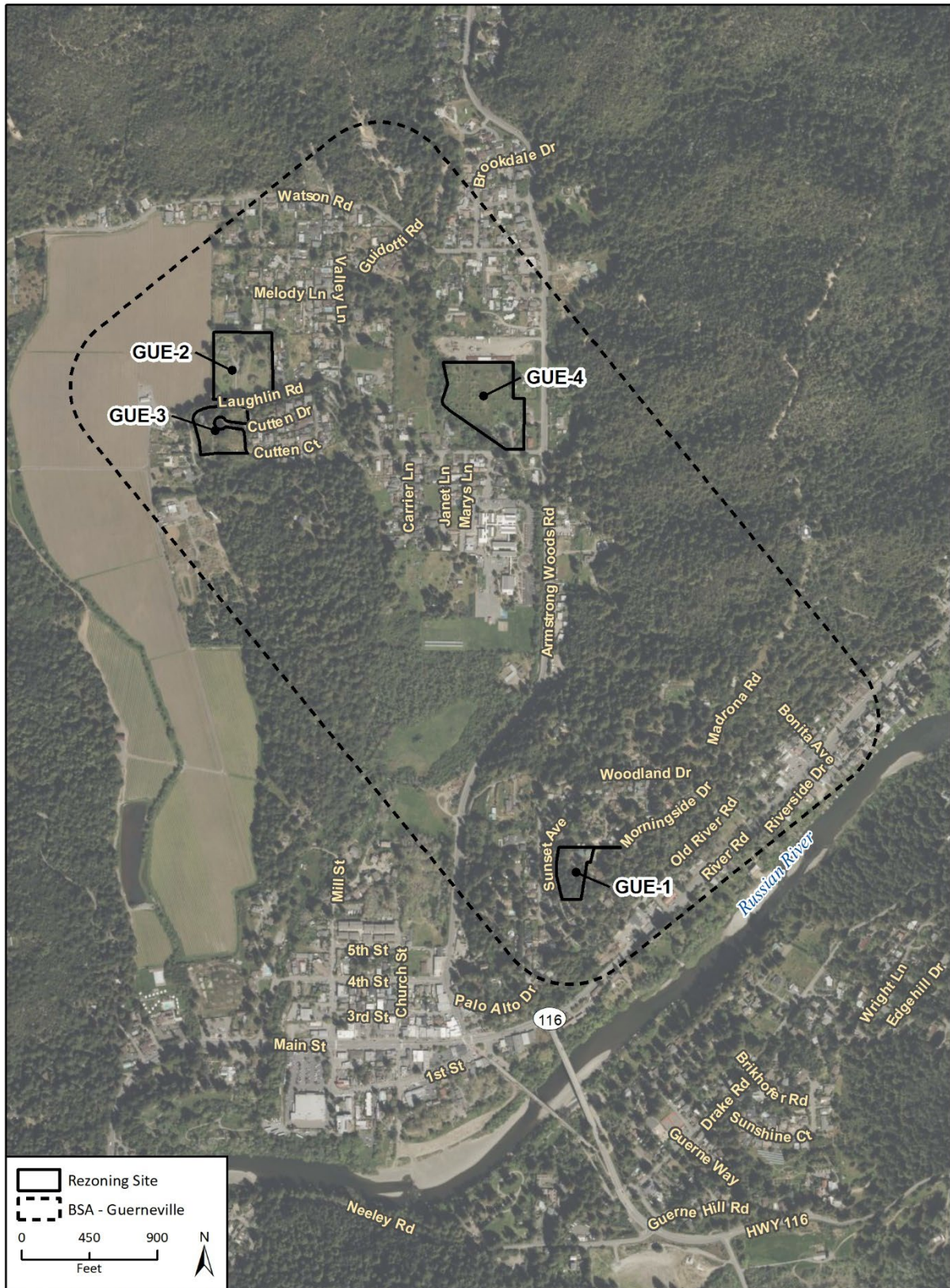


Figure 2g Biological Study Area – Larkfield

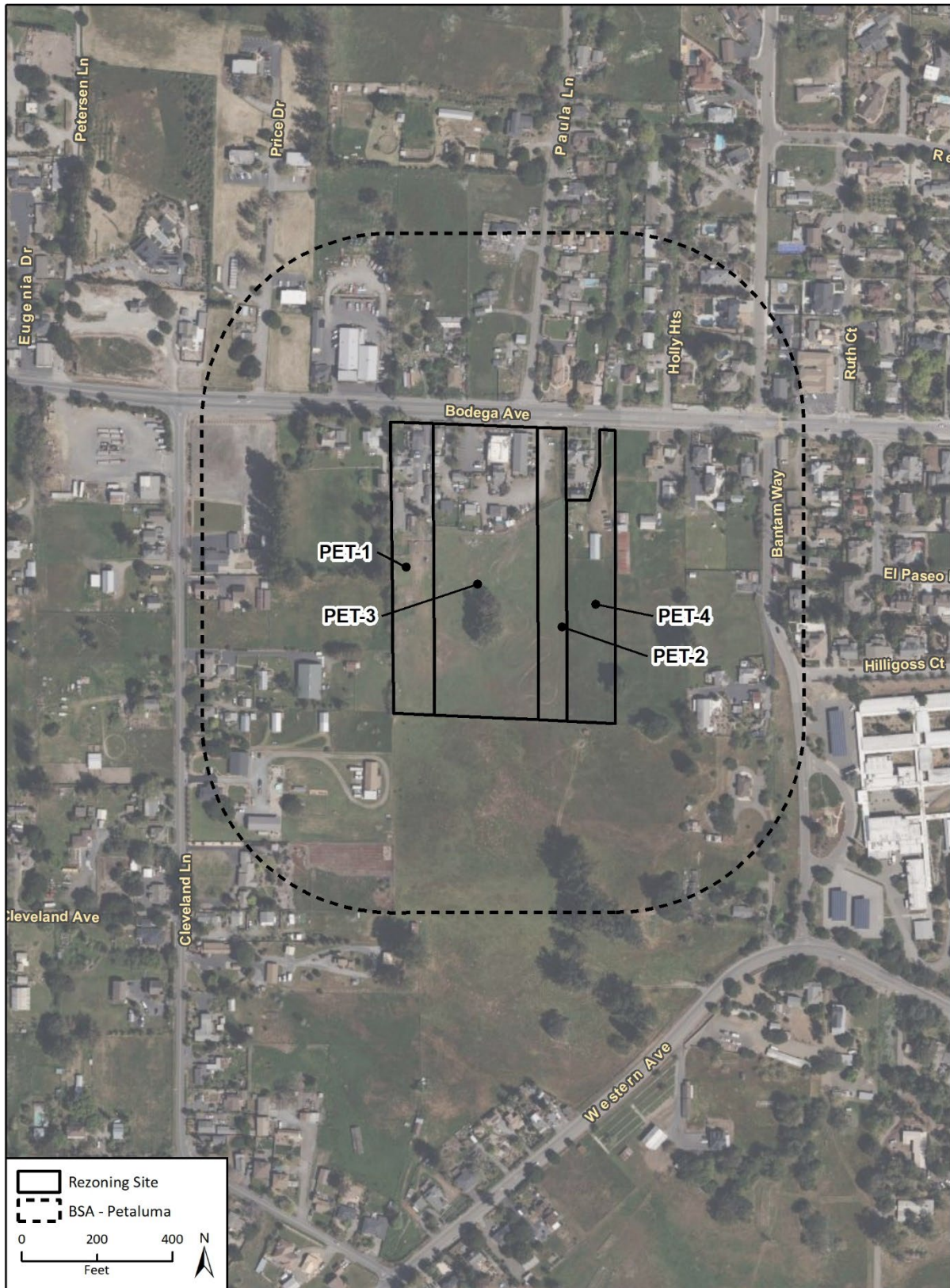


Imagery provided by Esri and its licensors © 2022.

Figure 2h Biological Study Area – Penngrove



Figure 2i Biological Study Area – Petaluma



Imagery provided by Microsoft Bing and its licensors © 2022.

Figure 2j Biological Study Area – Santa Rosa

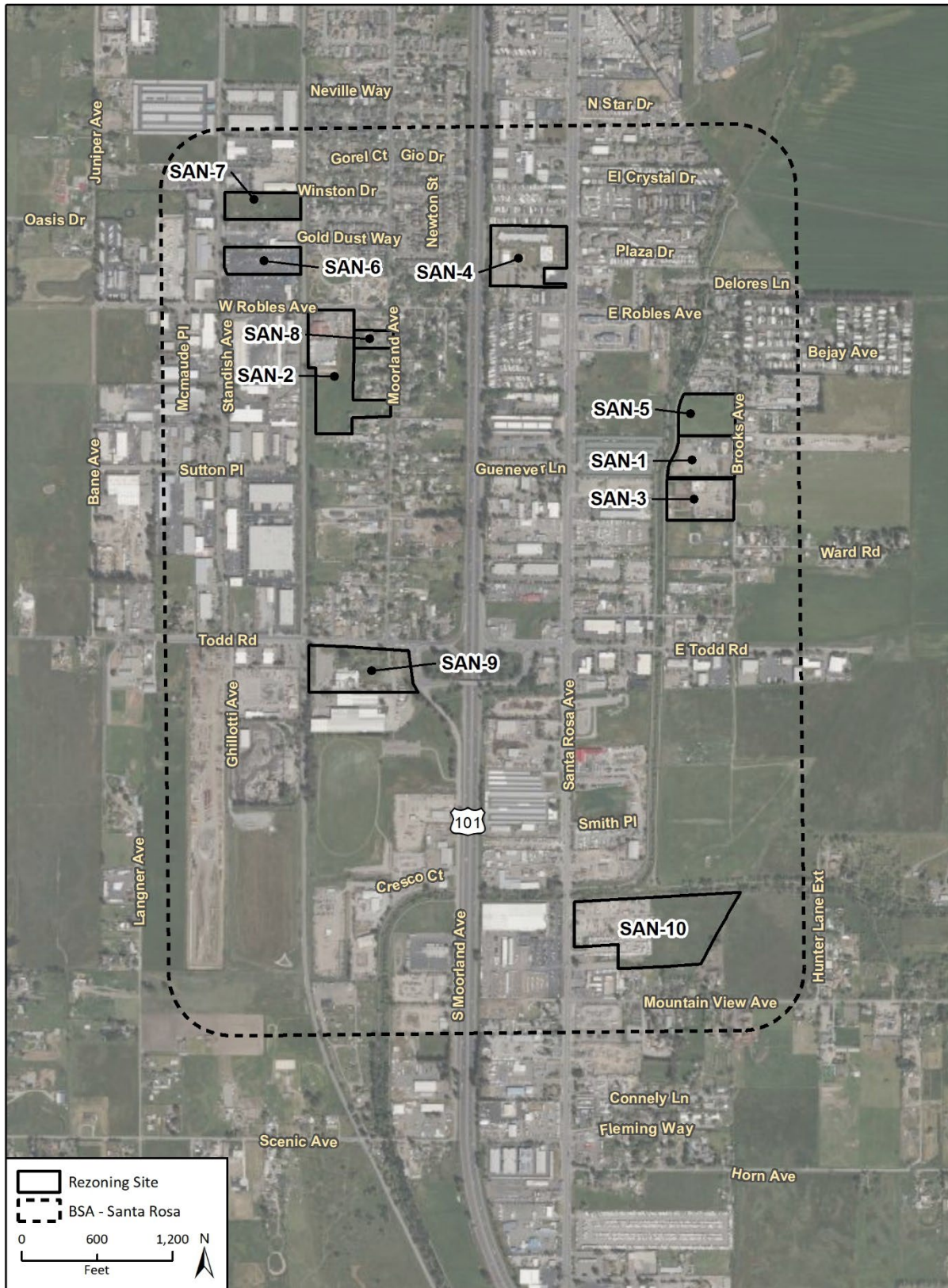


Figure 2k Biological Study Area – Sonoma

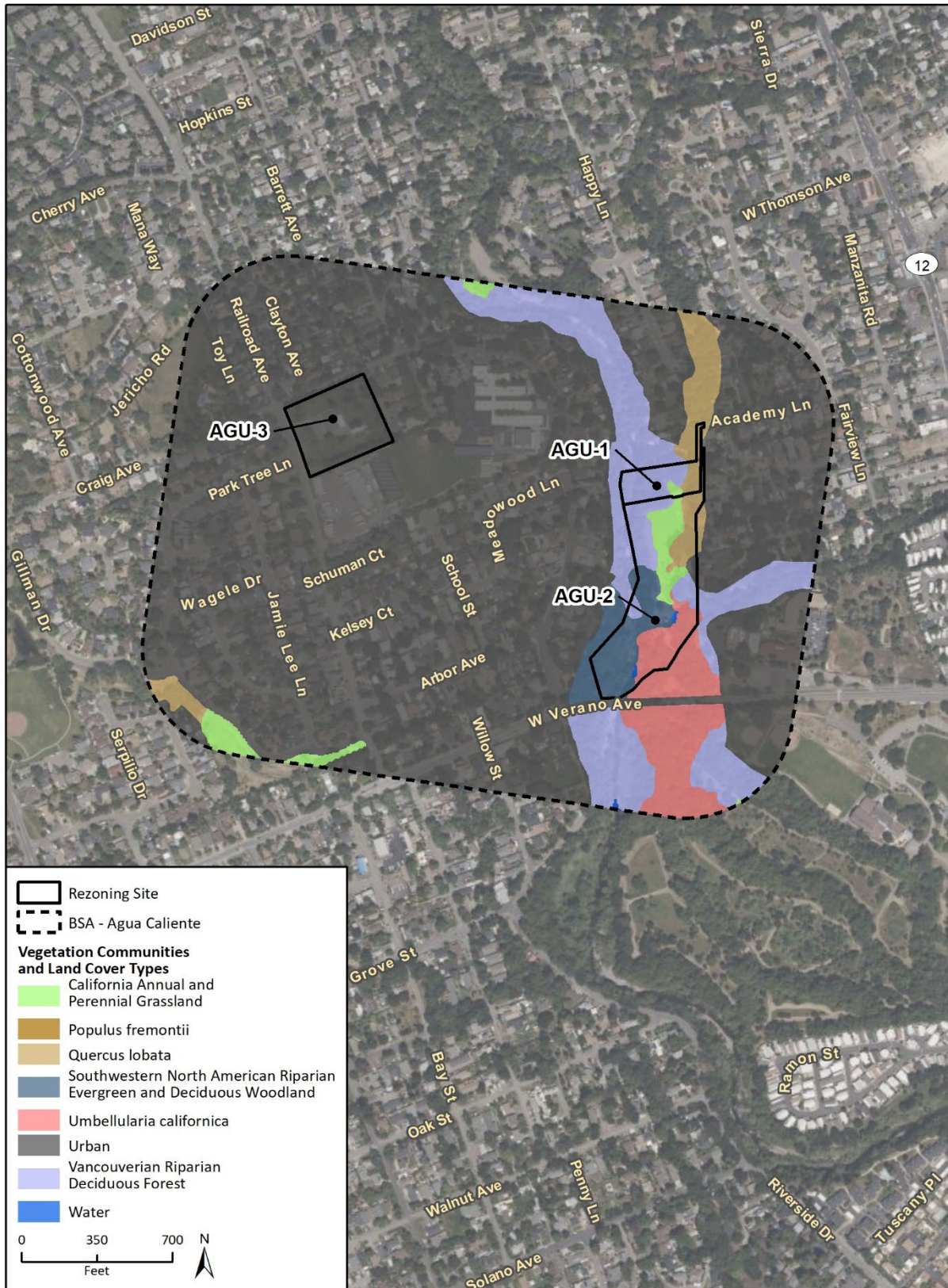


Imagery provided by Microsoft Bing and its licensors © 2022.

Additional data provided by Sonoma County Water Agency, Sonoma County Agricultural Preservation and Open Space District, Sonoma County Vegetation Mapping and LiDAR Program.

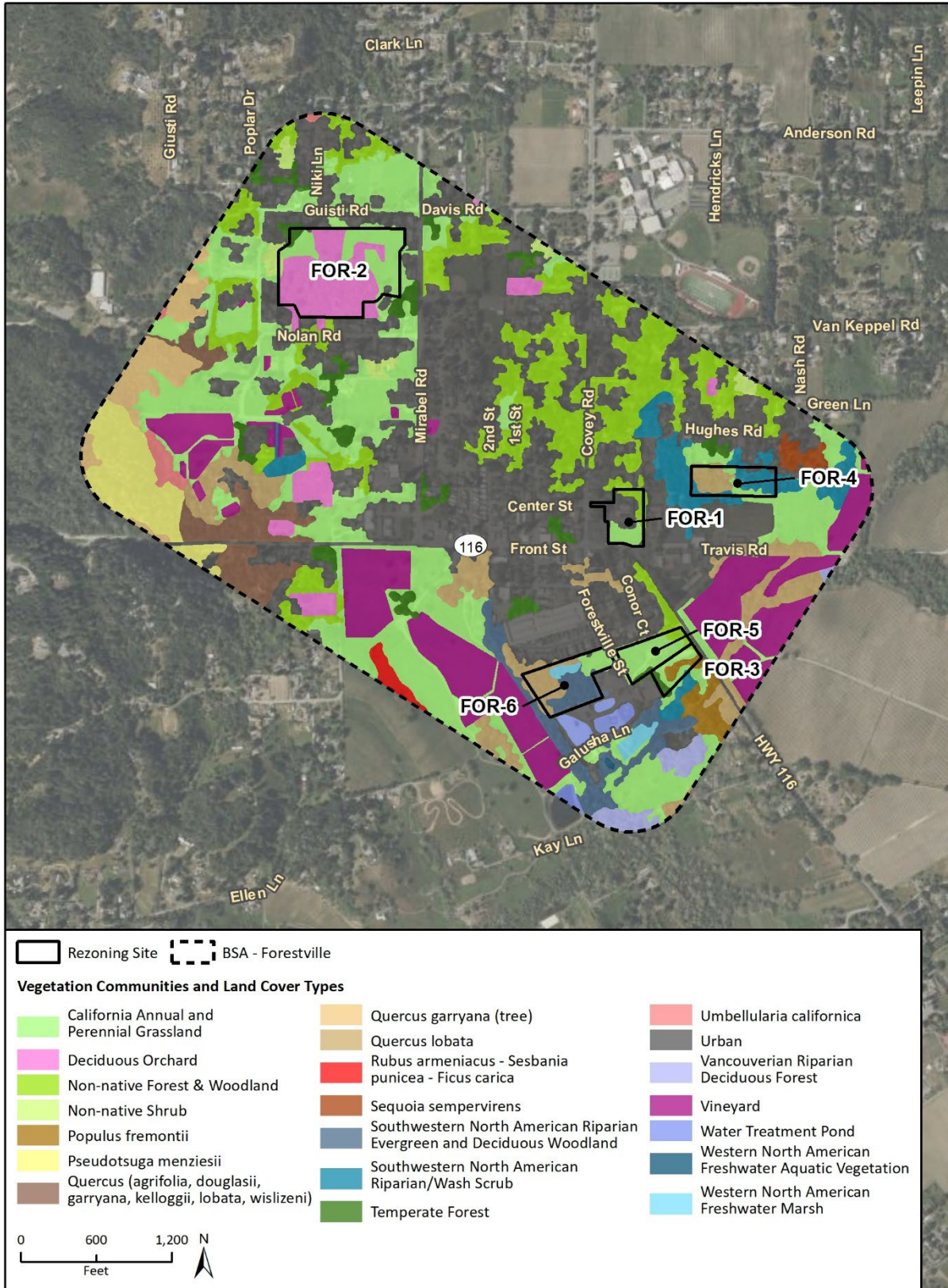


**Figure 3a Vegetation Communities and Land Cover Types – Agua Caliente**



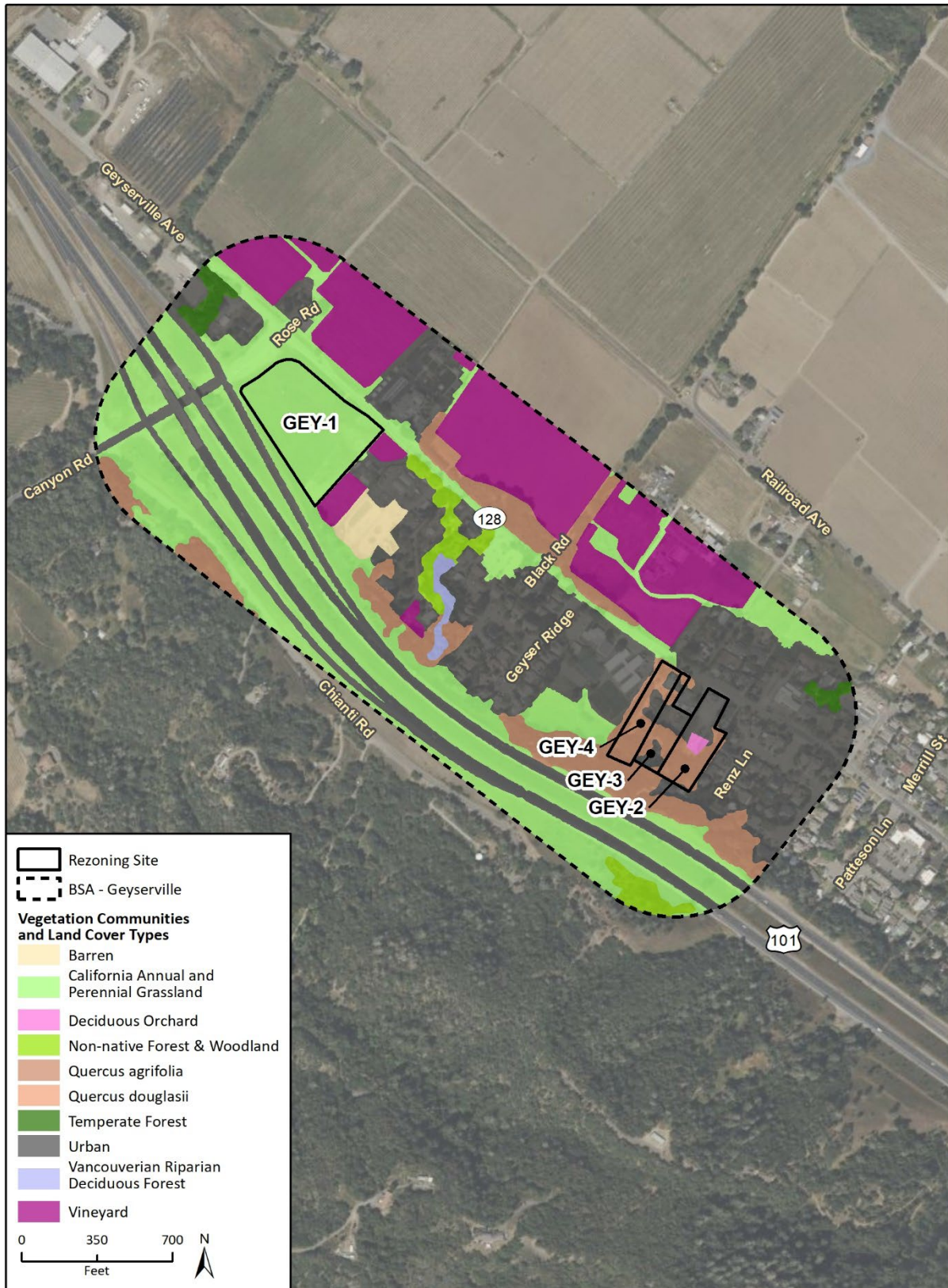
Imagery provided by Microsoft Bing and its licensors © 2022.  
Additional data provided by Sonoma County Water Agency, Sonoma County Agricultural Preservation and Open Space District, Sonoma County Vegetation Mapping and LiDAR Program.

**Figure 3b Vegetation Communities and Land Cover Types – Forestville**



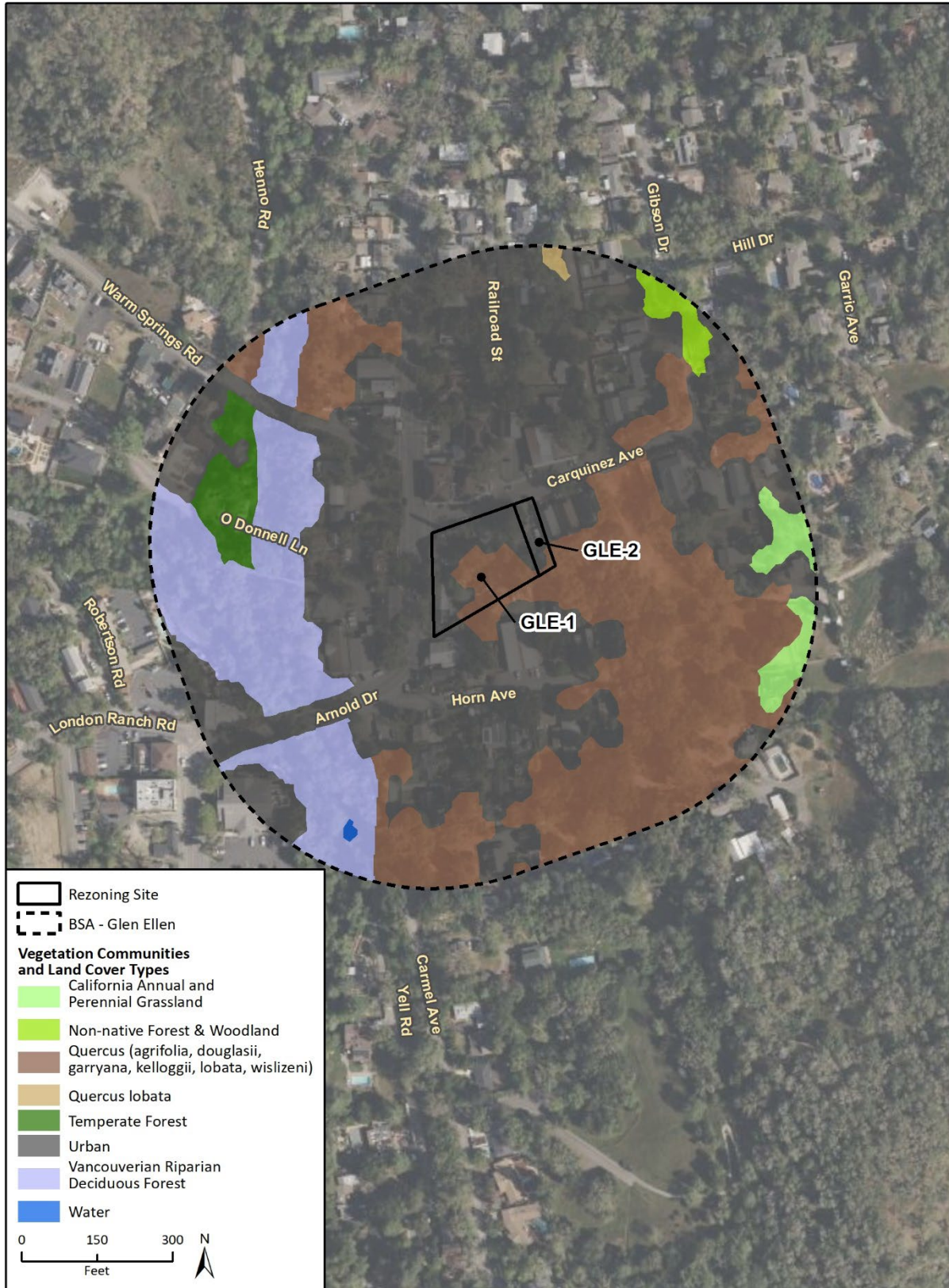
Imagery provided by Microsoft Bing and its licensors © 2022.  
 Additional data provided by Sonoma County Water Agency, Sonoma County Agricultural Preservation and Open Space District, Sonoma County Vegetation Mapping and LiDAR Program.

**Figure 3c Vegetation Communities and Land Cover Types – Geyserville**



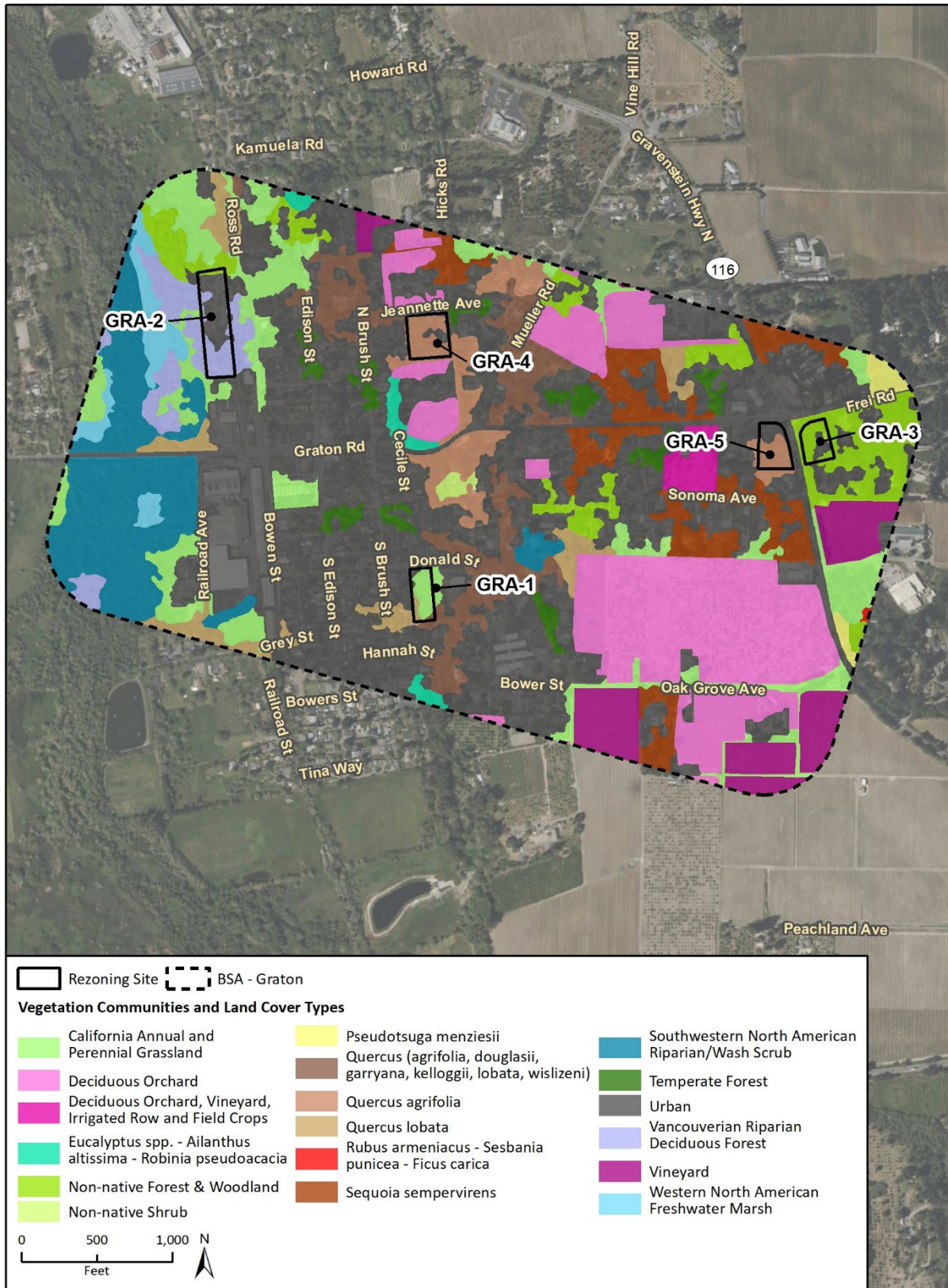
Imagery provided by Microsoft Bing and its licensors © 2022.  
 Additional data provided by Sonoma County Water Agency, Sonoma County Agricultural Preservation and Open Space District, Sonoma County Vegetation Mapping and LiDAR Program.

Figure 3d Vegetation Communities and Land Cover Types – Glen Ellen



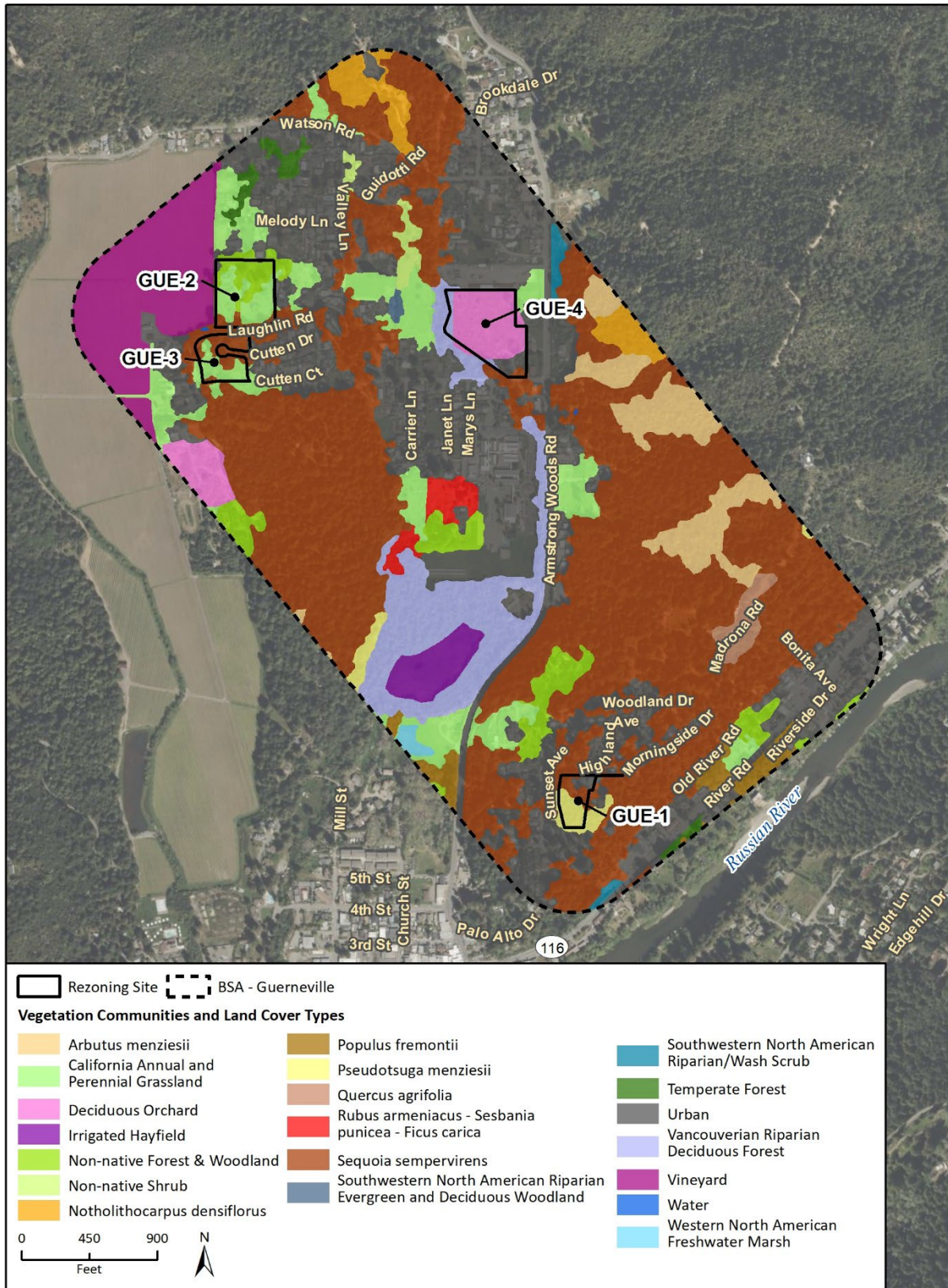
Imagery provided by Microsoft Bing and its licensors © 2022.  
 Additional data provided by Sonoma County Water Agency, Sonoma County Agricultural Preservation and Open Space District, Sonoma County Vegetation Mapping and LiDAR Program.

Figure 3e Vegetation Communities and Land Cover Types – Graton



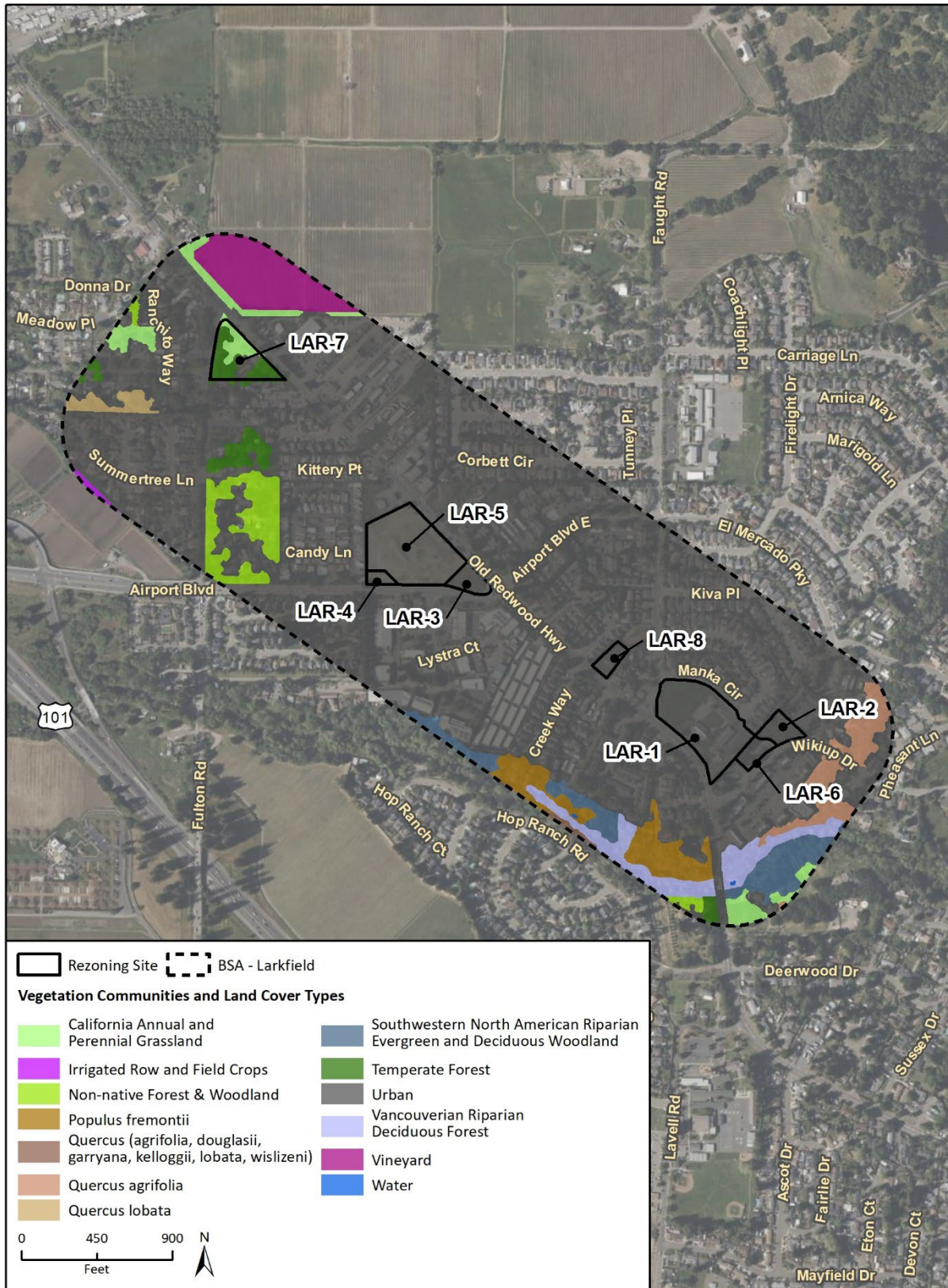
Imagery provided by Microsoft Bing and its licensors © 2022.  
 Additional data provided by Sonoma County Water Agency, Sonoma County Agricultural Preservation and Open Space District, Sonoma County Vegetation Mapping and LiDAR Program.

Figure 3f Vegetation Communities and Land Cover Types – Guerneville



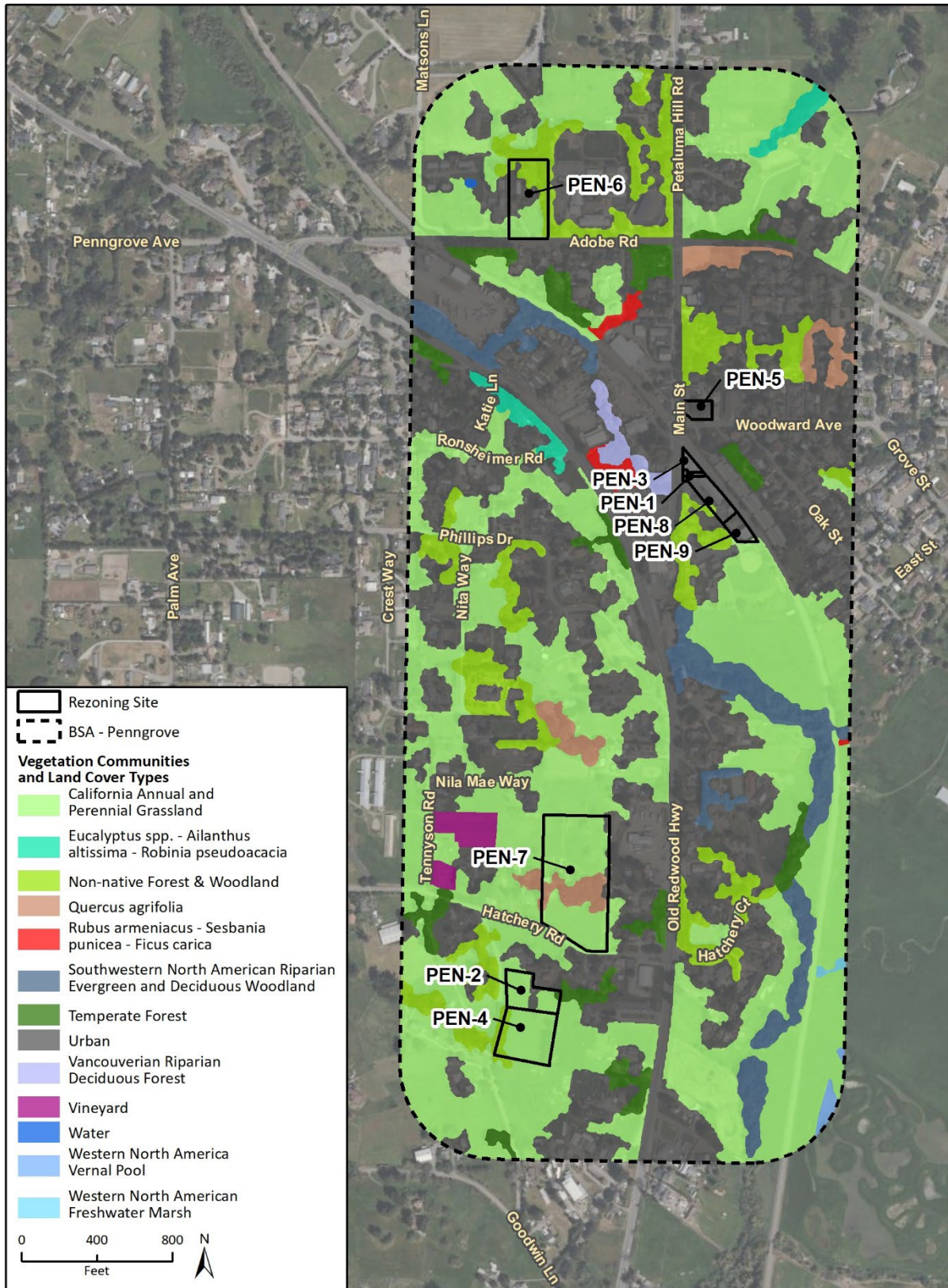
Imagery provided by Microsoft Bing and its licensors © 2022.  
 Additional data provided by Sonoma County Water Agency, Sonoma County Agricultural Preservation and Open Space District, Sonoma County Vegetation Mapping and LiDAR Program.

Figure 3g Vegetation Communities and Land Cover Types – Larkfield



Imagery provided by Microsoft Bing and its licensors © 2022.  
 Additional data provided by Sonoma County Water Agency, Sonoma County Agricultural Preservation and Open Space District, Sonoma County Vegetation Mapping and LiDAR Program.

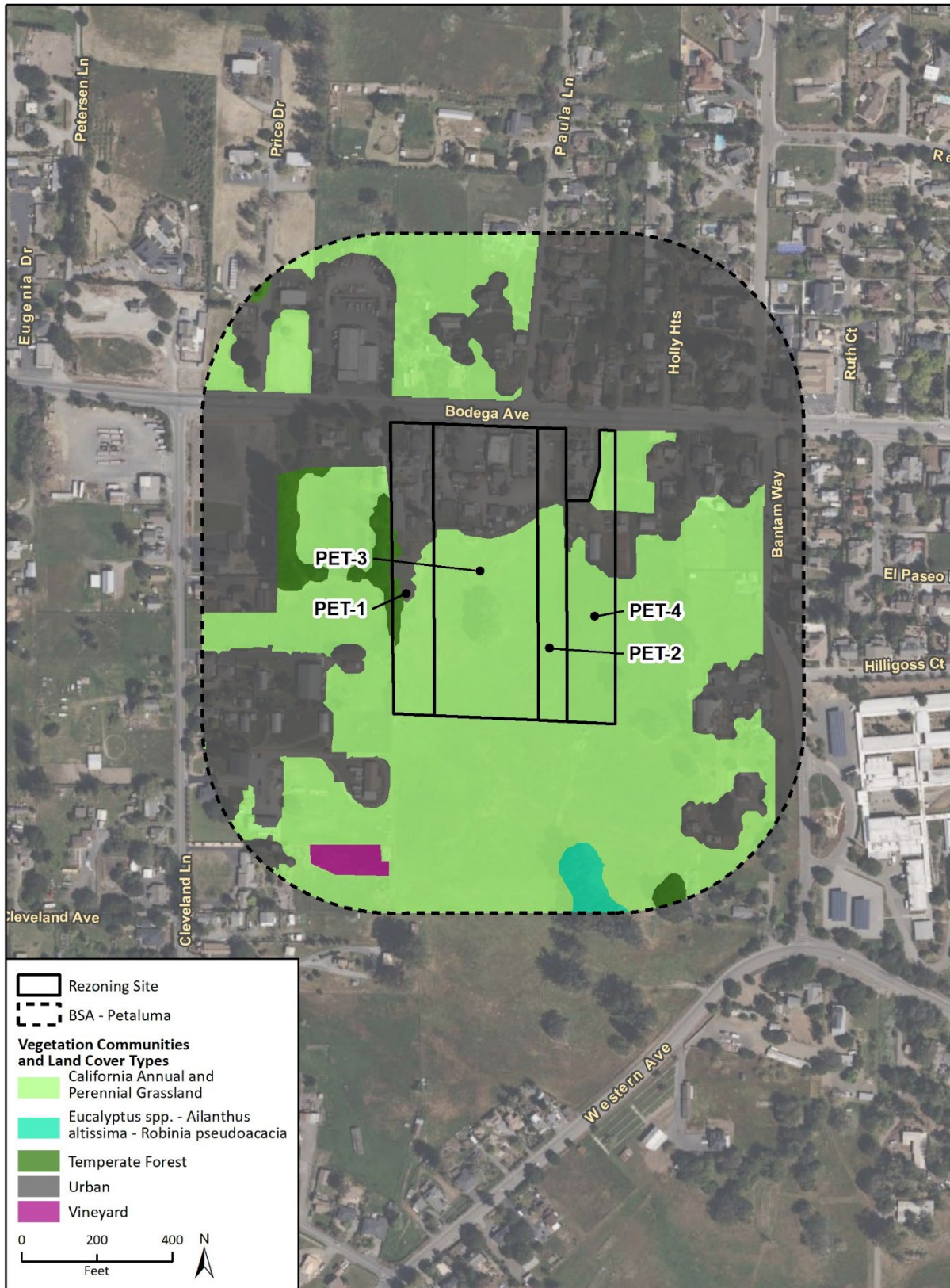
Figure 3h Vegetation Communities and Land Cover Types – Penngrove



Imagery provided by Microsoft Bing and its licensors © 2022.  
 Additional data provided by Sonoma County Water Agency, Sonoma County Agricultural Preservation and Open Space District, Sonoma County Vegetation Mapping and LiDAR Program.

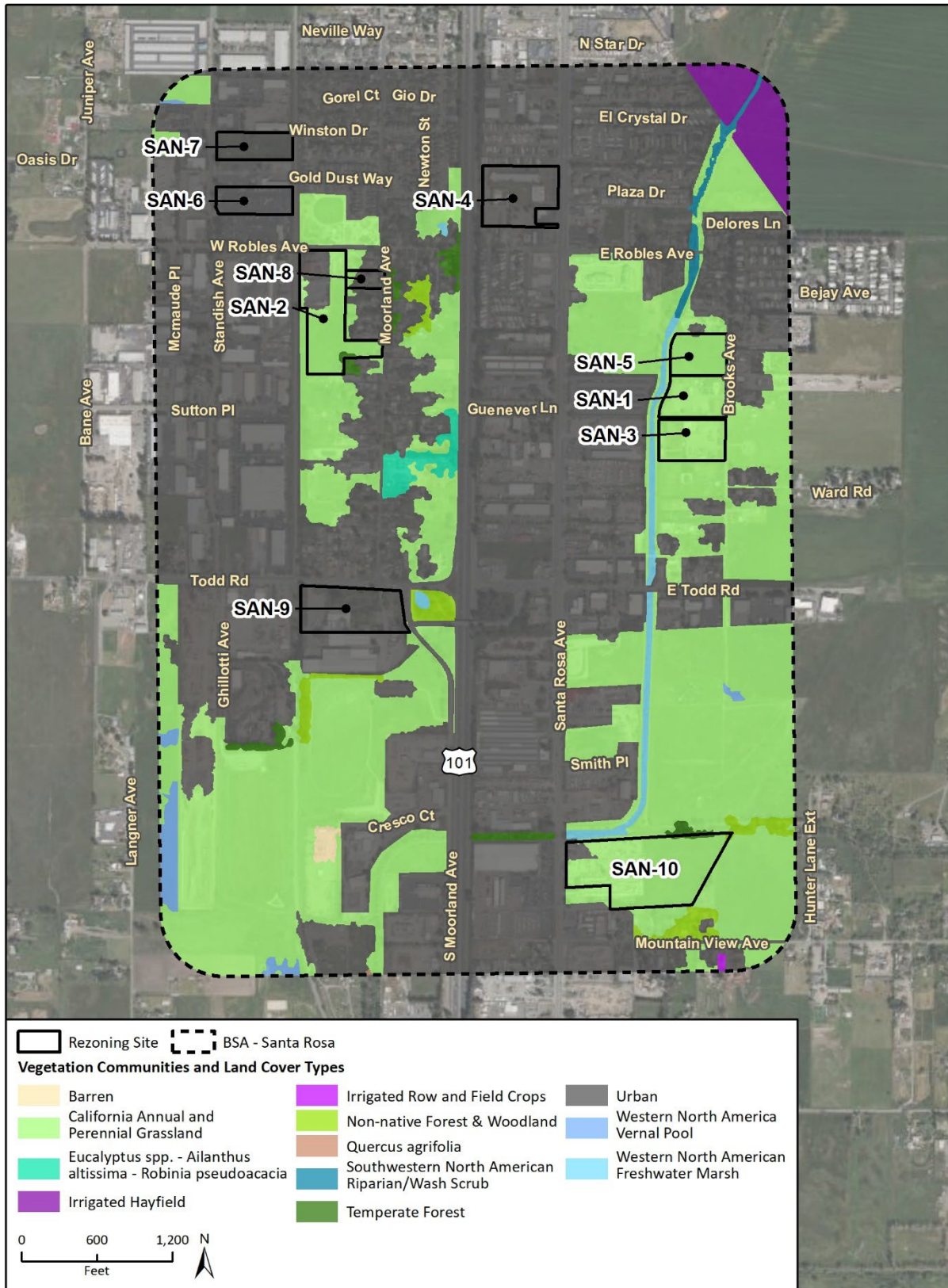


Figure 3i Vegetation Communities and Land Cover Types – Petaluma



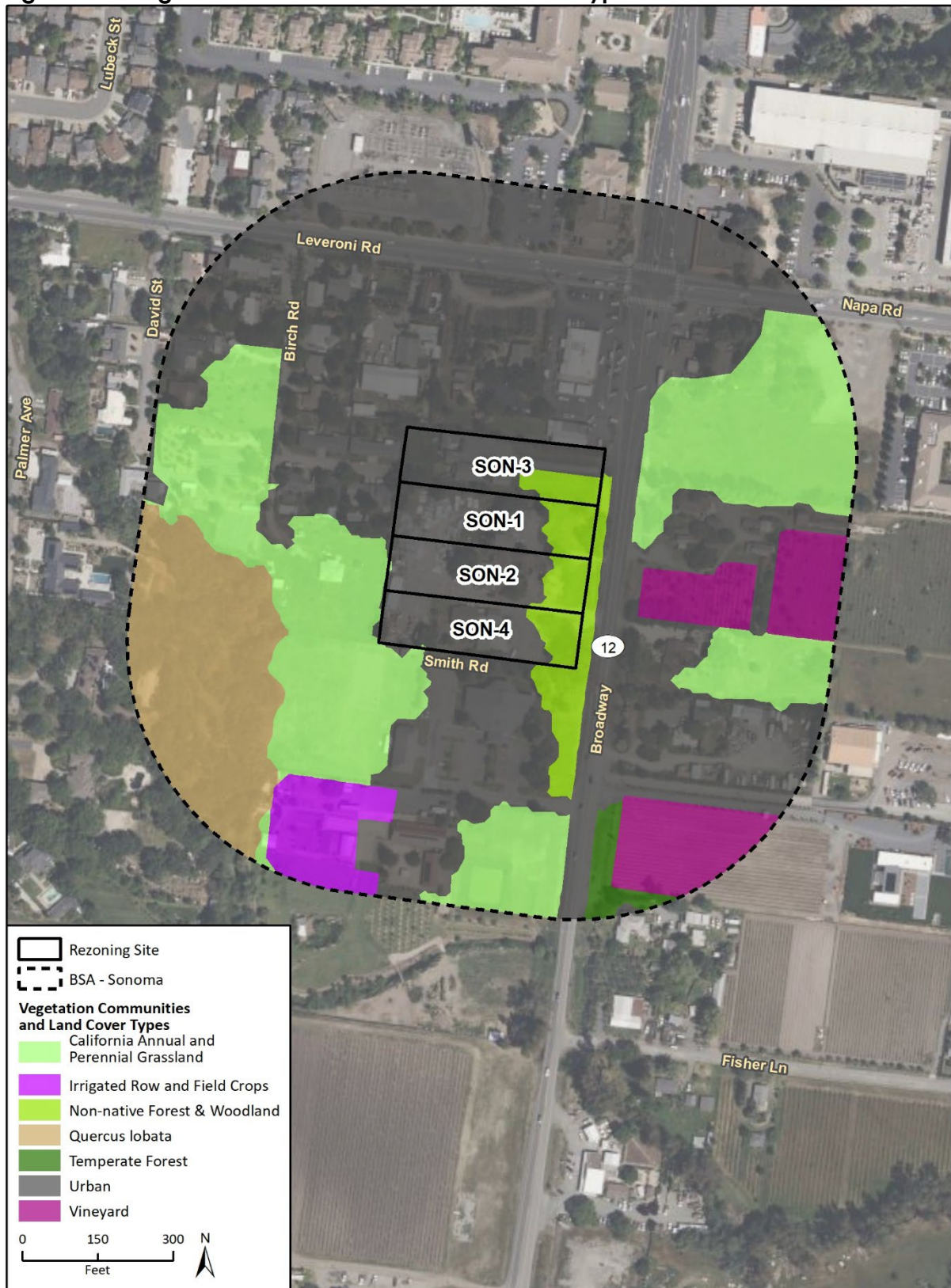
Imagery provided by Microsoft Bing and its licensors © 2022.  
 Additional data provided by Sonoma County Water Agency, Sonoma County Agricultural Preservation and Open Space District, Sonoma County Vegetation Mapping and LiDAR Program.

Figure 3j Vegetation Communities and Land Cover Types – Santa Rosa



Imagery provided by Microsoft Bing and its licensors © 2022.  
 Additional data provided by Sonoma County Water Agency, Sonoma County Agricultural Preservation and Open Space District, Sonoma County Vegetation Mapping and LiDAR Program.

Figure 3k Vegetation Communities and Land Cover Types – Sonoma



Imagery provided by Microsoft Bing and its licensors © 2022.

Additional data provided by Sonoma County Water Agency, Sonoma County Agricultural Preservation and Open Space District, Sonoma County Vegetation Mapping and LiDAR Program.

*This page intentionally left blank.*

# Appendix B

---

Regulatory Setting

# Regulatory Setting

---

Special-status habitats are vegetation types, associations, or sub-associations that support concentrations of special-status plant or animal species, are of relatively limited distribution, or are of particular value to wildlife.

Listed species are those taxa that are formally listed as endangered or threatened by the federal government (e.g. U.S. Fish and Wildlife Service [USFWS]), pursuant to the Federal Endangered Species Act (FESA) or as endangered, threatened, or rare (for plants only) by the State of California (i.e. California Fish and Game Commission), pursuant to the California Endangered Species Act or the California Native Plant Protection Act. Some species are considered rare (but not formally listed) by resource agencies, organizations with biological interests/expertise (e.g. Audubon Society, CNPS, The Wildlife Society), and the scientific community.

The following is a brief summary of the regulatory context under which biological resources are managed at the federal, state, and local levels. A number of federal and State statutes provide a regulatory structure that guides the protection of biological resources. Agencies with the responsibility for protection of biological resources within the project sites include:

1. U.S. Army Corps of Engineers (wetlands and other waters of the United States);
2. North Coast Regional Water Quality Control Board (waters of the State);
3. U.S. Fish and Wildlife Service (federally listed species and migratory birds);
4. California Department Fish and Wildlife (riparian areas, streambeds, and lakes; State-listed species; Species of Special Concern; nesting birds);
5. The County of Sonoma

## Federal

### U.S. Army Corps of Engineers

Under Section 404 of the Clean Water Act, the U.S. Army Corps of Engineers (USACE) has authority to regulate activities that could discharge fill of material into wetlands or other “waters of the United States.” Perennial and intermittent creeks are considered waters of the United States if they are hydrologically connected to other jurisdictional waters (typically a navigable water). The USACE also implements the federal policy embodied in Executive Order 11990, which is intended to result in no net loss of wetland value or acres. In achieving the goals of the Clean Water Act, the USACE seeks to avoid adverse impacts and offset unavoidable adverse impacts on existing aquatic resources. Any fill of wetlands that are hydrologically connected to jurisdictional waters would require a permit from the USACE prior to the start of work. Typically, when a project involves impacts to waters of the United States, the goal of no net loss of wetland acres or values is met through avoidance and minimization to the extent practicable, followed by compensatory mitigation involving creation or enhancement of similar habitats.

### *Regional Water Quality Control Board*

The State Water Resources Control Board (SWRCB) and the local Regional Water Quality Control Board (RWQCB) have jurisdiction over “waters of the State,” pursuant to the Porter-Cologne Water Quality Control Act, which are defined as any surface water or groundwater, including saline waters,

within the boundaries of the State. The SWRCB has issued general Waste Discharge Requirements (WDRs) regarding discharges to “isolated” waters of the State (Water Quality Order No. 2004-0004-DWQ, Statewide General Waste Discharge Requirements for Dredged or Fill Discharges to Waters Deemed by the U.S. Army Corps of Engineers to be Outside of Federal Jurisdiction). The RWQCB administers actions under this general order for isolated waters not subject to federal jurisdiction, and is also responsible for the issuance of water quality certifications pursuant to Section 401 of the Clean Water Act for waters subject to federal jurisdiction.

## United States Fish and Wildlife Service

The USFWS implements the Migratory Bird Treaty Act (16 United States Code [USC] Section 703-711) and the Bald and Golden Eagle Protection Act (16 USC Section 668). The USFWS and National Marine Fisheries Service (NMFS) share responsibility for implementing the Federal Endangered Species Act (FESA) (16 USC § 153 et seq.). Generally, the USFWS implements the FESA for terrestrial and freshwater species, while the NMFS implements the FESA for marine and anadromous species. Projects that would result in “take” of any federally threatened or endangered species are required to obtain permits from the USFWS or NMFS through either Section 7 (interagency consultation with a federal nexus) or Section 10 (Habitat Conservation Plan) of the FESA, depending on the involvement by the federal government in permitting and/or funding of the project. The permitting process is used to determine if a project would jeopardize the continued existence of a listed species and what measures would be required to avoid jeopardizing the species. “Take” under federal definition means to harass, harm (which includes habitat modification), pursue, hunt, shoot, wound, kill, trap, capture, or collect, or to attempt to engage in any such conduct. Proposed or candidate species do not have the full protection of the FESA; however, the USFWS and NMFS advise project applicants that they could be elevated to listed status at any time.

## State

### California Department of Fish and Wildlife

The California Department of Fish and Wildlife (CDFW) derives its authority from the Fish and Game Code of California. The California Endangered Species Act (CESA) (Fish and Game Code Section 2050 et. seq.) prohibits take of State-listed threatened or endangered. Take under CESA is restricted to direct mortality of a listed species and the law does not prohibit indirect harm by way of habitat modification. Where incidental take would occur during construction or other lawful activities, CESA allows the CDFW to issue an Incidental Take Permit upon finding, among other requirements, that impacts to the species have been minimized and fully mitigated.

The CDFW also enforces Sections 3511, 4700, 5050, and 5515 of the Fish and Game Code, which prohibits take of species designated as Fully Protected. The CDFW is not allowed to issue an Incidental Take Permit for Fully Protected species; therefore, impacts to these species must be avoided.

CGFC sections 3503, 3503.5, and 3513 describe unlawful take, possession, or destruction of native birds, nests, and eggs. Section 3503.5 of the Code protects all birds-of-prey and their eggs and nests against take, possession, or destruction of nests or eggs. Section 3513 makes it a State-level offense to take any bird in violation of the federal Migratory Bird Treaty Act. CDFW administers these requirements.

Species of Special Concern (SSC) is a category used by the CDFW for those species considered to be indicators of regional habitat changes or are considered to be potential future protected species.

Species of Special Concern do not have any special legal status except that which may be afforded by the Fish and Game Code as noted above. The SSC category is intended by the CDFW for use as a management tool to include these species in special consideration when decisions are made concerning the development of natural lands. The CDFW also has authority to administer the Native Plant Protection Act (NPPA) (Fish and Game Code Section 1900 et seq.). The NPPA requires the CDFW to establish criteria for determining if a species, subspecies, or variety of native plant is endangered or rare. Effective in 2015, CDFW promulgated regulations (14 CCR 786.9) under the authority of the NPPA, establishing that the CESA's permitting procedures would be applied to plants listed under the NPPA as "Rare." With this change, there is little practical difference for the regulated public between plants listed under CESA and those listed under the NPPA.

Perennial, intermittent, and ephemeral streams and associated riparian vegetation, when present, also fall under the jurisdiction of the CDFW. Section 1600 *et seq.* of the Fish and Game Code (Lake and Streambed Alteration Agreements) gives the CDFW regulatory authority over activities that divert, obstruct, or alter the channel, bed, or bank of any river, stream or lake.

## Local

### *Santa Rosa Plain Conservation Strategy Area*

The Santa Rosa Plain Conservation Strategy Area is a long-term agreement between USFWS, CDFW, and other federal and State agencies, and the County of Sonoma, the City of Santa Rosa and other local city governments. The USFWS issued a Programmatic Biological Opinion (BO) for the Conservation Strategy in 1998, which was superseded in 2007. The goal of the Conservation Strategy is to aid in the conservation of listed species and vernal pools by providing local governments and developers a way to obtain authorization for incidental take of federally listed species for development. Species covered under the BO include; California tiger salamander, Burke's goldfield (*Lasthenia burkei*), Sonoma sunshine (*Blennosperma bakeri*), Sebastopol meadowfoam (*Limnanthes vinculans*), and many-flowered navarretia (*Navarretia leucocephala* ssp. *pliantha*). The Conservation Strategy has yet to be finalized; however, the BO is in effect and may be implemented.

### *Sonoma County Zoning Code*

The Sonoma County Zoning Code Chapter 26D, *Heritage or Landmark Trees*, provides for the protection of heritage and landmark trees. The County defines a heritage tree as a tree or grove of trees designated by the Planning Commission as having historical interest or significance. A landmark tree is protected due to their outstanding characteristics in terms of size, age, rarity, shape, or location. The code requires a permit for the removal of or possible damage to a heritage or landmark tree, including application for a building, grading or demolition permit.

Sonoma County Zoning Code Article 88, Section 26-88-010(m), *Tree Protection Ordinance*, requires projects to be designed to minimize the removal of protected trees that meet size and species criteria specified in the ordinance, and replanting for trees removed.

Additionally, Valley oak woodlands in the Valley Oak Habitat Combining District (Article 67) are protected, and special mitigation measures. For removal of any large valley oak, or any small valley oaks having a cumulative diameter at breast height (DBH) greater than 20 inches (large), or 60 inches (small) at DBH, 16 replacement trees and up to \$50 of in-lieu fees are required, additionally 1 tree with the same, or greater, cumulative DBH must be retained. If small valley oaks with a cumulative DBH between 80 to 100 inches will be removed mitigation will include 20 replacement trees and/or a \$75 in-lieu fee.



Sonoma County  
**Rezone Sites for Housing Project**

Riparian corridors are also protected by Article 65, *Riparian Corridor Combining Zone*. This combining zone protects County-designated streams, including the bed, bank, and an adjacent streamside conservation areas as measured from the top of bank or the outer drip line of the riparian trees. Specific setbacks for agricultural cultivation are determined based on the affected river or stream and site-specific conditions but generally include a 25-200 foot setback. This ordinance also outlines allowed activities such as, but not limited to, levee maintenance, invasive plant removal, and maintenance of existing landscaped areas.

*Sonoma County General Plan 2020*

The Sonoma County General Plan 2020 (Sonoma County 2008, amended 2016) includes policies to guide decisions on future growth, development, and conservation of resources through 2020. This includes the “Open Space and Resource Conservation Elements” which aims to preserve the natural and scenic resources that contribute to the general welfare and quality of life for the residents of the county and maintains its tourist industry.

# Appendix C

---

Special Status Species Evaluation Tables

## Special Status Plant and Lichen Species in the Regional Vicinity of the Project Site

Scientific Name Common Name	Status Fed/ State ESA CRPR	Habitat Requirements	GEY	GUE	LAR	FOR	GRA	SAN	GLE	AGU	PEN	PET	SON	
<i>Abronia umbellata</i> var. <i>breviflora</i> pink sand-verbena	None/None G4G5T2/S2 1B.1	Coastal dunes. 0 - 10 m. perennial herb. Blooms Jun-Oct	<b>Not Expected;</b> suitable vegetation communities are not present.	<b>Not Expected;</b> suitable vegetation communities are not present.	<b>Not Expected;</b> suitable vegetation communities are not present.	<b>Not Expected;</b> suitable vegetation communities are not present.	<b>Not Expected;</b> suitable vegetation communities are not present.	<b>Not Expected;</b> suitable vegetation communities are not present.	<b>Not Expected;</b> suitable vegetation communities are not present.	<b>Not Expected;</b> suitable vegetation communities are not present.	<b>Not Expected;</b> suitable vegetation communities are not present.	<b>Not Expected;</b> suitable vegetation communities are not present.	<b>Not Expected;</b> suitable vegetation communities are not present.	
<i>Agrostis blasdalei</i> Blasdale's bent grass	None/None G2/S2 1B.2	Coastal bluff scrub, Coastal dunes, Coastal prairie. 0 - 150 m. perennial rhizomatous herb. Blooms May-Jul	<b>Not Expected;</b> suitable vegetation communities are not present.	<b>Not Expected;</b> suitable vegetation communities are not present.	<b>Not Expected;</b> suitable vegetation communities are not present.	<b>Not Expected;</b> suitable vegetation communities are not present.	<b>Not Expected;</b> suitable vegetation communities are not present.	<b>Not Expected;</b> suitable vegetation communities are not present.	<b>Not Expected;</b> suitable vegetation communities are not present.	<b>Not Expected;</b> suitable vegetation communities are not present.	<b>Not Expected;</b> suitable vegetation communities are not present.	<b>Not Expected;</b> suitable vegetation communities are not present.	<b>Not Expected;</b> suitable vegetation communities are not present.	
<i>Allium peninsulare</i> var. <i>franciscanum</i> Franciscan onion	None/None G5T2/S2 1B.2	Cismontane woodland, Valley and foothill grassland. clay, volcanic, often serpentinite. 52 -305 m. perennial bulbiferous herb. Blooms (Apr)May-Jun	<b>Low Potential;</b> suitable vegetation communities are present, suitable soils may be present.	<b>Low Potential;</b> suitable vegetation communities are present, suitable soils may be present.	<b>Low Potential;</b> suitable vegetation communities are present, suitable soils may be present.	<b>Low Potential;</b> suitable vegetation communities are present, suitable soils may be present.	<b>Low Potential;</b> suitable vegetation communities are present, suitable soils may be present.	<b>Low Potential;</b> suitable vegetation communities are present, suitable soils may be present.	<b>Low Potential;</b> suitable vegetation communities are present, suitable soils may be present.	<b>Low Potential;</b> suitable vegetation communities are present, suitable soils may be present.	<b>Low Potential;</b> suitable vegetation communities are present, suitable soils may be present.	<b>Low Potential;</b> suitable vegetation communities are present, suitable soils may be present.	<b>Low Potential;</b> suitable vegetation communities are present, suitable soils may be present.	
<i>Alopecurus aequalis</i> var. <i>sonomensis</i> Sonoma alopecurus	FE/None G5T1/S1 1B.1	Marshes and swamps (freshwater), Riparian scrub. 5 -365 m. perennial herb. Blooms May-Jul	<b>Not Expected;</b> suitable wetland habitats and vegetation communities are not present.	<b>Moderate Potential;</b> freshwater aquatic habitats are present.	<b>Moderate Potential;</b> freshwater aquatic habitats are present.	<b>Present;</b> freshwater aquatic habitats are present; a presumed extant occurrence is mapped within the BSA.	<b>Moderate Potential;</b> freshwater aquatic habitats are present.	<b>Moderate Potential;</b> freshwater aquatic habitats are present.	<b>Moderate Potential;</b> freshwater aquatic habitats are present.	<b>Moderate Potential;</b> freshwater aquatic habitats are present.	<b>Moderate Potential;</b> freshwater aquatic habitats are present.	<b>Moderate Potential;</b> freshwater aquatic habitats are present.	<b>Not Expected;</b> suitable wetland habitats and vegetation communities are not present.	<b>Moderate Potential;</b> freshwater aquatic habitats are present.
<i>Amorpha californica</i> var. <i>napensis</i> Napa false indigo	None/None G4T2/S2 1B.2	Broadleafed upland forest (openings), Chaparral, Cismontane woodland. 120 - 2000 m. perennial deciduous shrub. Blooms Apr-Jul	<b>Low Potential;</b> suitable vegetation communities are present.	<b>Low Potential;</b> suitable vegetation communities are present.	<b>Low Potential;</b> suitable vegetation communities are present.	<b>Low Potential;</b> suitable vegetation communities are present.	<b>Low Potential;</b> suitable vegetation communities are present.	<b>Low Potential;</b> suitable vegetation communities are present.	<b>Low Potential;</b> suitable vegetation communities are present.	<b>Low Potential;</b> suitable vegetation communities are present.	<b>Low Potential;</b> suitable vegetation communities are present.	<b>Low Potential;</b> suitable vegetation communities are present.	<b>Low Potential;</b> suitable vegetation communities are present.	
<i>Amsinckia lunaris</i> bent-flowered fiddleneck	None/None G3/S3 1B.2	Coastal bluff scrub, Cismontane woodland, Valley and foothill grassland. 3 - 500 m. annual herb. Blooms Mar-Jun	<b>Low Potential;</b> Cismontane woodland, Valley and foothill grasslands are present.	<b>Low Potential;</b> suitable vegetation communities are present.	<b>Low Potential;</b> suitable vegetation communities are present.	<b>Low Potential;</b> suitable vegetation communities are present.	<b>Low Potential;</b> suitable vegetation communities are present.	<b>Low Potential;</b> suitable vegetation communities are present.	<b>Low Potential;</b> suitable vegetation communities are present.	<b>Low Potential;</b> suitable vegetation communities are present.	<b>Low Potential;</b> suitable vegetation communities are present.	<b>Low Potential;</b> suitable vegetation communities are present.	<b>Low Potential;</b> suitable vegetation communities are present.	
<i>Arctostaphylos bakeri</i> ssp. <i>bakeri</i> Baker's manzanita	None/SR G2T1/S1 1B.1	Broadleafed upland forest, Chaparral. often serpentinite. 75 - 300 m. perennial evergreen shrub. Blooms Feb-Apr	<b>Low Potential;</b> suitable vegetation communities are present, suitable soils may be present.	<b>Low Potential;</b> suitable vegetation communities are present, suitable soils may be present.	<b>Low Potential;</b> suitable vegetation communities are present, suitable soils may be present.	<b>Low Potential;</b> suitable vegetation communities are present, suitable soils may be present.	<b>Low Potential;</b> suitable vegetation communities are present, suitable soils may be present.	<b>Low Potential;</b> suitable vegetation communities are present, suitable soils may be present.	<b>Low Potential;</b> suitable vegetation communities are present, suitable soils may be present.	<b>Low Potential;</b> suitable vegetation communities are present, suitable soils may be present.	<b>Low Potential;</b> suitable vegetation communities are present, suitable soils may be present.	<b>Low Potential;</b> suitable vegetation communities are present, suitable soils may be present.	<b>Low Potential;</b> suitable vegetation communities are present, suitable soils may be present.	
<i>Arctostaphylos bakeri</i> ssp. <i>sublaevis</i> Cedars manzanita	None/SR G2T2/S2 1B.2 BLM_S-Sensitive	Closed-cone coniferous forest, Chaparral. serpentinite seeps. 185 - 760 m. perennial evergreen shrub. Blooms Feb, Apr, May	<b>Not Expected;</b> suitable vegetation communities are not present.	<b>Not Expected;</b> suitable vegetation communities are not present.	<b>Not Expected;</b> suitable vegetation communities are not present.	<b>Not Expected;</b> suitable vegetation communities are not present.	<b>Not Expected;</b> suitable vegetation communities are not present.	<b>Not Expected;</b> suitable vegetation communities are not present.	<b>Not Expected;</b> suitable vegetation communities are not present.	<b>Not Expected;</b> suitable vegetation communities are not present.	<b>Not Expected;</b> suitable vegetation communities are not present.	<b>Not Expected;</b> suitable vegetation communities are not present.	<b>Not Expected;</b> suitable vegetation communities are not present.	

Sonoma County  
**Rezone Sites for Housing Project**

Scientific Name Common Name	Status Fed/ State ESA CRPR	Habitat Requirements	GEY	GUE	LAR	FOR	GRA	SAN	GLE	AGU	PEN	PET	SON
<i>Arctostaphylos densiflora</i> Vine Hill manzanita	None/SE G1/S1 1B.1	Chaparral (acid marine sand). 50-120 m. perennial evergreenshrub. Blooms Feb-Apr	<b>Not Expected;</b> suitable vegetation communities and soils are not present.	<b>Not Expected;</b> suitable vegetation communities and soils are not present.	<b>Not Expected;</b> suitable vegetation communities and soils are not present.	<b>Not Expected;</b> suitable vegetation communities and soils are not present.	<b>Not Expected;</b> suitable vegetation communities and soils are not present.	<b>Not Expected;</b> suitable vegetation communities and soils are not present.	<b>Not Expected;</b> suitable vegetation communities and soils are not present.	<b>Not Expected;</b> suitable vegetation communities and soils are not present.	<b>Not Expected;</b> suitable vegetation communities and soils are not present.	<b>Not Expected;</b> suitable vegetation communities and soils are not present.	<b>Not Expected;</b> suitable vegetation communities and soils are not present.
<i>Arctostaphylos manzanita</i> <i>ssp. elegans</i> Konocti manzanita	None/None G5T3/S3 1B.3	Chaparral, Cismontane woodland, Lower montane coniferous forest. volcanic. 395-1615 m. perennial evergreen shrub. Blooms (Jan)Mar- May(Jul)	<b>Low Potential;</b> suitable vegetation communities are present, suitable soils may be present.	<b>Low Potential;</b> suitable vegetation communities are present, suitable soils may be present.	<b>Low Potential;</b> suitable vegetation communities are present, suitable soils may be present.	<b>Low Potential;</b> suitable vegetation communities are present, suitable soils may be present.	<b>Low Potential;</b> suitable vegetation communities are present, suitable soils may be present.	<b>Low Potential;</b> suitable vegetation communities are present, suitable soils may be present.	<b>Low Potential;</b> suitable vegetation communities are present, suitable soils may be present.	<b>Low Potential;</b> suitable vegetation communities are present, suitable soils may be present.	<b>Low Potential;</b> suitable vegetation communities are present, suitable soils may be present.	<b>Not Expected;</b> suitable vegetation communities are not present.	<b>Low Potential;</b> suitable vegetation communities are present, suitable soils may be present.
<i>Arctostaphylos montana</i> <i>ssp. montana</i> Mt. Tamalpais manzanita	None/None G3T3/S3 1B.3	Perennial evergreen shrub. Chaparral, valley and foothill grassland. Rocky, serpentinite. Elevations: 525-2495ft. (160-760m.) Blooms Feb-Apr.	<b>Not Expected;</b> suitable vegetation communities and soils are not present.	<b>Not Expected;</b> suitable vegetation communities and soils are not present.	<b>Not Expected;</b> suitable vegetation communities and soils are not present.	<b>Not Expected;</b> suitable vegetation communities and soils are not present.	<b>Not Expected;</b> suitable vegetation communities and soils are not present.	<b>Not Expected;</b> suitable vegetation communities and soils are not present.	<b>Not Expected;</b> suitable vegetation communities and soils are not present.	<b>Not Expected;</b> suitable vegetation communities and soils are not present.	<b>Not Expected;</b> suitable vegetation communities and soils are not present.	<b>Not Expected;</b> suitable vegetation communities and soils are not present.	<b>Not Expected;</b> suitable vegetation communities and soils are not present.
<i>Arctostaphylos stanfordiana</i> <i>ssp. decumbens</i> Rincon Ridge manzanita	None/None G3T1/S1 1B.1	Chaparral (rhyolitic), Cismontane woodland. 75--370m. perennial evergreen shrub. Blooms Feb-Apr(May)	<b>Low Potential;</b> suitable vegetation communities are present, suitable soils may be present	<b>Low Potential;</b> suitable vegetation communities are present, suitable soils may be present	<b>Low Potential;</b> suitable vegetation communities are present, suitable soils may be present	<b>Low Potential;</b> suitable vegetation communities are present, suitable soils may be present	<b>Low Potential;</b> suitable vegetation communities are present, suitable soils may be present	<b>Low Potential;</b> suitable vegetation communities are present, suitable soils may be present	<b>Low Potential;</b> suitable vegetation communities are present, suitable soils may be present	<b>Low Potential;</b> suitable vegetation communities are present, suitable soils may be present	<b>Low Potential;</b> suitable vegetation communities are present, suitable soils may be present	<b>Low Potential;</b> suitable vegetation communities are present, suitable soils may be present	<b>Low Potential;</b> suitable vegetation communities are present, suitable soils may be present
<i>Arctostaphylos stanfordiana</i> <i>ssp. raichei</i> Raiche's manzanita	None/None G2/S2 1B.1	Perennial evergreen shrub. Chaparral, lower montane coniferous forest. Rocky, serpentinite (often). Elevations: 1475-3395ft. (450-1035m.) Blooms Feb- Apr.	<b>Not Expected;</b> suitable vegetation communities and soils are not present.	<b>Not Expected;</b> suitable vegetation communities and soils are not present.	<b>Not Expected;</b> suitable vegetation communities and soils are not present.	<b>Not Expected;</b> suitable vegetation communities and soils are not present.	<b>Not Expected;</b> suitable vegetation communities and soils are not present.	<b>Not Expected;</b> suitable vegetation communities and soils are not present.	<b>Not Expected;</b> suitable vegetation communities and soils are not present.	<b>Not Expected;</b> suitable vegetation communities and soils are not present.	<b>Not Expected;</b> suitable vegetation communities and soils are not present.	<b>Not Expected;</b> suitable vegetation communities and soils are not present.	<b>Not Expected;</b> suitable vegetation communities and soils are not present.
<i>Arctostaphylos virgata</i> Marin manzanita	FE/SCE G1/S1 1B.2	Perennial evergreen shrub. Broadleafed upland forest, chaparral, closed-cone coniferous forest, north coast coniferous forest. Granitic (sometimes), sandstone (sometimes). Elevations: 195-2295ft. (60-700m.) Blooms Jan-Mar.	<b>Not Expected;</b> suitable vegetation communities and soils are not present.	<b>Low Potential;</b> suitable vegetation communities are present, suitable soils may be present	<b>Not Expected;</b> suitable vegetation communities and soils are not present.	<b>Not Expected;</b> suitable vegetation communities and soils are not present.	<b>Not Expected;</b> suitable vegetation communities and soils are not present.	<b>Not Expected;</b> suitable vegetation communities and soils are not present.	<b>Low Potential;</b> suitable vegetation communities are present, suitable soils may be present	<b>Not Expected;</b> suitable vegetation communities and soils are not present.	<b>Not Expected;</b> suitable vegetation communities and soils are not present.	<b>Not Expected;</b> suitable vegetation communities and soils are not present.	<b>Not Expected;</b> suitable vegetation communities and soils are not present.
<i>Astragalus claranus</i> Clara Hunt's milk- vetch	FE/ST G1/S1 1B.1	Chaparral (openings), Cismontane woodland, Valley and foothill grassland. serpentinite or volcanic, rocky,clay. 75-275 m. annual herb. Blooms Mar-May	<b>Low Potential;</b> suitable vegetation communities are present, suitable soils may be present	<b>Low Potential;</b> suitable vegetation communities are present, suitable soils may be present	<b>Low Potential;</b> suitable vegetation communities are present, suitable soils may be present	<b>Low Potential;</b> suitable vegetation communities are present, suitable soils may be present	<b>Low Potential;</b> suitable vegetation communities are present, suitable soils may be present	<b>Low Potential;</b> suitable vegetation communities are present, suitable soils may be present	<b>Low Potential;</b> suitable vegetation communities are present, suitable soils may be present	<b>Low Potential;</b> suitable vegetation communities are present, suitable soils may be present	<b>Low Potential;</b> suitable vegetation communities are present, suitable soils may be present	<b>Low Potential;</b> suitable vegetation communities are present, suitable soils may be present	<b>Low Potential;</b> suitable vegetation communities are present, suitable soils may be present

Scientific Name Common Name	Status Fed/ State ESA CRPR	Habitat Requirements	GEY	GUE	LAR	FOR	GRA	SAN	GLE	AGU	PEN	PET	SON
<i>Astragalus pycnostachyus</i> <i>var. pycnostachyus</i> coastal marsh milk-vetch	None/None G2T2/S2 1B.2	Perennial herb. Coastal dunes, coastal scrub, marshes and swamps. Mesic sites in dunes or along streams or coastal salt marshes. Elevations: 0-100ft. (0-30m.) Blooms (Apr)Jun-Oct.	<b>Not Expected;</b> suitable, vernal pool habitats and vegetation communities are not present.	<b>Not Expected;</b> suitable, vernal pool habitats and vegetation communities are not present.	<b>Not Expected;</b> suitable, vernal pool habitats and vegetation communities are not present.	<b>Not Expected;</b> suitable, vernal pool habitats and vegetation communities are not present.	<b>Not Expected;</b> suitable, vernal pool habitats and vegetation communities are not present.	<b>Moderate Potential;</b> suitable vegetation communities are present.	<b>Not Expected;</b> suitable, vernal pool habitats and vegetation communities are not present.	<b>Not Expected;</b> suitable, vernal pool habitats and vegetation communities are not present.	<b>Moderate Potential;</b> suitable vegetation communities are present.	<b>Not Expected;</b> suitable, vernal pool habitats and vegetation communities are not present.	<b>Not Expected;</b> suitable, vernal pool habitats and vegetation communities are not present.
<i>Astragalus rattanii</i> <i>var. jepsonianus</i> Jepson's milk-vetch	None/None G4T3/S3 1B.2	Chaparral, Cismontane woodland, Valley and foothill grassland. often serpentinite. 295-700m. annual herb. Blooms Mar-Jun	<b>Not Expected;</b> suitable vegetation communities and soils are not present.	<b>Not Expected;</b> suitable vegetation communities and soils are not present.	<b>Not Expected;</b> suitable vegetation communities and soils are not present.	<b>Not Expected;</b> suitable vegetation communities and soils are not present.	<b>Not Expected;</b> suitable vegetation communities and soils are not present.	<b>Not Expected;</b> suitable vegetation communities and soils are not present.	<b>Not Expected;</b> suitable vegetation communities and soils are not present.	<b>Not Expected;</b> suitable vegetation communities and soils are not present.	<b>Not Expected;</b> suitable vegetation communities and soils are not present.	<b>Not Expected;</b> suitable vegetation communities and soils are not present.	<b>Not Expected;</b> suitable vegetation communities and soils are not present.
<i>Astragalus tener</i> <i>var. tener</i> alkali milk-vetch	None/None G2T1/S1 1B.2	Playas, Valley and foothill grassland (adobe clay), Vernal pools. alkaline. 1-60 m. annual herb. Blooms Mar-Jun	<b>Not Expected;</b> suitable, vernal pool habitats and vegetation communities are not present.	<b>Not Expected;</b> suitable, vernal pool habitats and vegetation communities are not present.	<b>Not Expected;</b> suitable, vernal pool habitats and vegetation communities are not present.	<b>Not Expected;</b> suitable, vernal pool habitats and vegetation communities are not present.	<b>Not Expected;</b> suitable, vernal pool habitats and vegetation communities are not present.	<b>Moderate Potential;</b> suitable vegetation communities are present.	<b>Not Expected;</b> suitable, vernal pool habitats and vegetation communities are not present.	<b>Not Expected;</b> suitable, vernal pool habitats and vegetation communities are not present.	<b>Moderate Potential;</b> suitable vegetation communities are present.	<b>Not Expected;</b> suitable, vernal pool habitats and vegetation communities are not present.	<b>Not Expected;</b> suitable, vernal pool habitats and vegetation communities are not present.
<i>Balsamorhizamacrolepis</i> big-scale balsamroot	None/None G2/S2 1B.2	Chaparral, Cismontane woodland, Valley and foothill grassland. sometimes serpentinite. 45-1555 m. perennial herb. Blooms Mar-Jun	<b>Not Expected;</b> suitable vegetation communities and soils are not present.	<b>Not Expected;</b> suitable vegetation communities and soils are not present.	<b>Not Expected;</b> suitable vegetation communities and soils are not present.	<b>Not Expected;</b> suitable vegetation communities and soils are not present.	<b>Not Expected;</b> suitable vegetation communities and soils are not present.	<b>Not Expected;</b> suitable vegetation communities and soils are not present.	<b>Not Expected;</b> suitable vegetation communities and soils are not present.	<b>Not Expected;</b> suitable vegetation communities and soils are not present.	<b>Not Expected;</b> suitable vegetation communities and soils are not present.	<b>Not Expected;</b> suitable vegetation communities and soils are not present.	<b>Not Expected;</b> suitable vegetation communities and soils are not present.
<i>Blennospermabakeri</i> Sonoma sunshine	FE/SE G1/S1 1B.1	Valley and foothill grassland (mesic), Vernal pools. 10-110m. annual herb. Blooms Mar-May	<b>Not Expected;</b> suitable, vernal pool habitats and vegetation communities are not present.	<b>Not Expected;</b> suitable, vernal pool habitats and vegetation communities are not present.	<b>Not Expected;</b> suitable, vernal pool habitats and vegetation communities are not present.	<b>Not Expected;</b> suitable, vernal pool habitats and vegetation communities are not present.	<b>Not Expected;</b> suitable, vernal pool habitats and vegetation communities are not present.	<b>Moderate Potential;</b> suitable vegetation communities are present.	<b>Not Expected;</b> suitable, vernal pool habitats and vegetation communities are not present.	<b>Not Expected;</b> suitable, vernal pool habitats and vegetation communities are not present.	<b>Moderate Potential;</b> suitable vegetation communities are present.	<b>Not Expected;</b> suitable, vernal pool habitats and vegetation communities are not present.	<b>Not Expected;</b> suitable, vernal pool habitats and vegetation communities are not present.
<i>Brodiaea leptandra</i> narrow-anthered brodiaea	None/None G3?/S3? 1B.2	Broadleafed upland forest, Chaparral, Cismontane woodland, Lower montane coniferous forest, Valley and foothill grassland. volcanic. 110-915 m. perennial bulbiferous herb. Blooms May-Jul	<b>Low Potential;</b> suitable vegetation communities are present, suitable soils may be present	<b>Low Potential;</b> suitable vegetation communities are present, suitable soils may be present	<b>Low Potential;</b> suitable vegetation communities are present, suitable soils may be present	<b>Low Potential;</b> suitable vegetation communities are present, suitable soils may be present	<b>Low Potential;</b> suitable vegetation communities are present, suitable soils may be present	<b>Low Potential;</b> suitable vegetation communities are present, suitable soils may be present	<b>Low Potential;</b> suitable vegetation communities are present, suitable soils may be present	<b>Low Potential;</b> suitable vegetation communities are present, suitable soils may be present	<b>Low Potential;</b> suitable vegetation communities are present, suitable soils may be present	<b>Low Potential;</b> suitable vegetation communities are present, suitable soils may be present	<b>Low Potential;</b> suitable vegetation communities are present, suitable soils may be present
<i>Calamagrostis crassiglumis</i> Thurber's reed grass	None/None G3Q/S2 2B.1	Coastal scrub (mesic), Marshes and swamps (freshwater). 10-60 m. perennial rhizomatous herb. Blooms May-Aug	<b>Not Expected;</b> suitable aquatic habitats and vegetation communities are not present	<b>Moderate Potential;</b> freshwater habitats are present.	<b>Moderate Potential;</b> freshwater habitats are present.	<b>Moderate Potential;</b> freshwater habitats are present.	<b>Moderate Potential;</b> freshwater habitats are present.	<b>Moderate Potential;</b> freshwater habitats are present.	<b>Moderate Potential;</b> freshwater habitats are present.	<b>Moderate Potential;</b> freshwater habitats are present.	<b>Moderate Potential;</b> freshwater habitats are present.	<b>Not Expected;</b> suitable aquatic habitats and vegetation communities are not present	<b>Moderate Potential;</b> freshwater aquatic habitats are present.
<i>Calochortus raichei</i> Cedars fairy-lantern	None/None G2/S2 1B.2	Closed-cone coniferous forest, Chaparral. serpentinite. 200-490 m. perennial bulbiferous herb. Blooms May-Aug	<b>Not Expected;</b> suitable vegetation communities are not present.	<b>Not Expected;</b> suitable vegetation communities are not present.	<b>Not Expected;</b> suitable vegetation communities are not present.	<b>Not Expected;</b> suitable vegetation communities are not present.	<b>Not Expected;</b> suitable vegetation communities are not present.	<b>Not Expected;</b> suitable vegetation communities are not present.	<b>Not Expected;</b> suitable vegetation communities are not present.	<b>Not Expected;</b> suitable vegetation communities are not present.	<b>Not Expected;</b> suitable vegetation communities are not present.	<b>Not Expected;</b> suitable vegetation communities are not present.	<b>Not Expected;</b> suitable vegetation communities are not present.

Sonoma County  
**Rezone Sites for Housing Project**

Scientific Name Common Name	Status Fed/ State ESA CRPR	Habitat Requirements	GEY	GUE	LAR	FOR	GRA	SAN	GLE	AGU	PEN	PET	SON
<i>Calystegia collina</i> <i>ssp. tridactylosa</i> three-fingered morning-glory	None/None G4T1/S1 1B.2	Perennial rhizomatous herb. Chaparral, cismontane woodland. Gravelly, openings, rocky, serpentinite. Elevations: 0-1970ft. (0-600m.) Blooms Apr-Jun.	<b>Low Potential;</b> suitable vegetation communities are present, suitable soils may be present	<b>Low Potential;</b> suitable vegetation communities are present, suitable soils may be present	<b>Low Potential;</b> suitable vegetation communities are present, suitable soils may be present	<b>Low Potential;</b> suitable vegetation communities are present, suitable soils may be present	<b>Low Potential;</b> suitable vegetation communities are present, suitable soils may be present	<b>Low Potential;</b> suitable vegetation communities are present, suitable soils may be present	<b>Low Potential;</b> suitable vegetation communities are present, suitable soils may be present	<b>Low Potential;</b> suitable vegetation communities are present, suitable soils may be present	<b>Low Potential;</b> suitable vegetation communities are present, suitable soils may be present	<b>Low Potential;</b> suitable vegetation communities are present, suitable soils may be present	<b>Low Potential;</b> suitable vegetation communities are present, suitable soils may be present
<i>Calystegia purpurata ssp. saxicola</i> coastal bluff morning-glory	None/None G4T2T3/S2S3 1B.2	Coastal bluff scrub, Coastal dunes, Coastal scrub, North Coast coniferous forest. 0-105m. perennial herb. Blooms(Mar)Apr-Sep	<b>Not Expected;</b> suitable vegetation communities are not present.	<b>Not Expected;</b> suitable vegetation communities are not present.	<b>Not Expected;</b> suitable vegetation communities are not present.	<b>Not Expected;</b> suitable vegetation communities are not present.	<b>Not Expected;</b> suitable vegetation communities are not present.	<b>Not Expected;</b> suitable vegetation communities are not present.	<b>Not Expected;</b> suitable vegetation communities are not present.	<b>Not Expected;</b> suitable vegetation communities are not present.	<b>Not Expected;</b> suitable vegetation communities are not present.	<b>Not Expected;</b> suitable vegetation communities are not present.	<b>Not Expected;</b> suitable vegetation communities are not present.
<i>Campanula californica</i> swamp harebell	None/None G3/S3 1B.2	Bogs and fens, Closed-cone coniferous forest, Coastal prairie, Meadows and seeps, Marshes and swamps (freshwater), North Coast coniferous forest. mesic. 1-405m. perennial rhizomatous herb. Blooms Jun-Oct	<b>Not Expected;</b> suitable aquatic habitats and vegetation communities are not present	<b>Low Potential;</b> freshwater habitats are present.	<b>Low Potential;</b> freshwater habitats are present.	<b>Low Potential;</b> freshwater habitats are present.	<b>Low Potential;</b> freshwater habitats are present.	<b>Low Potential;</b> freshwater habitats are present.	<b>Low Potential;</b> freshwater habitats are present.	<b>Low Potential;</b> freshwater habitats are present.	<b>Low Potential;</b> freshwater habitats are present.	<b>Not Expected;</b> suitable aquatic habitats and vegetation communities are not present	<b>Moderate Potential;</b> freshwater aquatic habitats are present.
<i>Cardamine angulate</i> seaside bittercress	None/None G4G5/S3 2B.1	Perennial herb. Lower montane coniferous forest, north coast coniferous forest. Streambanks. Elevations: 50-3000ft. (15-915m.) Blooms (Jan)Mar-Jul.	<b>Not Expected;</b> suitable vegetation communities are not present.	<b>Not Expected;</b> suitable vegetation communities are not present.	<b>Not Expected;</b> suitable vegetation communities are not present.	<b>Not Expected;</b> suitable vegetation communities are not present.	<b>Not Expected;</b> suitable vegetation communities are not present.	<b>Not Expected;</b> suitable vegetation communities are not present.	<b>Not Expected;</b> suitable vegetation communities are not present.	<b>Not Expected;</b> suitable vegetation communities are not present.	<b>Not Expected;</b> suitable vegetation communities are not present.	<b>Not Expected;</b> suitable vegetation communities are not present.	<b>Not Expected;</b> suitable vegetation communities are not present.
<i>Carex comosa</i> bristly sedge	None/None G5/S2 2B.1	Coastal prairie, Marshes and swamps (lake margins), Valley and foothill grassland. 0-625m. perennial rhizomatous herb. Blooms May-Sep	<b>Not Expected;</b> suitable aquatic habitats and vegetation communities are not present	<b>Moderate Potential;</b> freshwater habitats are present.	<b>Moderate Potential;</b> freshwater habitats are present.	<b>Moderate Potential;</b> freshwater habitats are present.	<b>Moderate Potential;</b> freshwater habitats are present.	<b>Moderate Potential;</b> freshwater habitats are present.	<b>Moderate Potential;</b> freshwater habitats are present.	<b>Moderate Potential;</b> freshwater habitats are present.	<b>Moderate Potential;</b> freshwater habitats are present.	<b>Not Expected;</b> suitable aquatic habitats and vegetation communities are not present	<b>Moderate Potential;</b> freshwater aquatic habitats are present.
<i>Carex lyngbyei</i> Lyngbye's sedge	None/None G5/S3 2B.2	Perennial rhizomatous herb. Marshes and swamps. Elevations: 0-35ft. (0-10m.) Blooms Apr-Aug.	<b>Not Expected;</b> suitable aquatic habitats and vegetation communities are not present	<b>Moderate Potential;</b> freshwater habitats are present.	<b>Moderate Potential;</b> freshwater habitats are present.	<b>Moderate Potential;</b> freshwater habitats are present.	<b>Moderate Potential;</b> freshwater habitats are present.	<b>Moderate Potential;</b> freshwater habitats are present.	<b>Moderate Potential;</b> freshwater habitats are present.	<b>Moderate Potential;</b> freshwater habitats are present.	<b>Moderate Potential;</b> freshwater habitats are present.	<b>Not Expected;</b> suitable aquatic habitats and vegetation communities are not present	<b>Moderate Potential;</b> freshwater aquatic habitats are present.
<i>Carex saliniformis</i> deceiving sedge	None/None G2/S2 1B.2	Coastal prairie, Coastal scrub, Meadows and seeps, Marshes and swamps (coastal salt). mesic. 3-230 m. perennial rhizomatous herb. Blooms May-Jun (Jul)	<b>Not Expected;</b> suitable aquatic habitats and vegetation communities are not present	<b>Moderate Potential;</b> freshwater habitats are present.	<b>Moderate Potential;</b> freshwater habitats are present.	<b>Moderate Potential;</b> freshwater habitats are present.	<b>Moderate Potential;</b> freshwater habitats are present.	<b>Moderate Potential;</b> freshwater habitats are present.	<b>Moderate Potential;</b> freshwater habitats are present.	<b>Moderate Potential;</b> freshwater habitats are present.	<b>Moderate Potential;</b> freshwater habitats are present.	<b>Not Expected;</b> suitable aquatic habitats and vegetation communities are not present	<b>Moderate Potential;</b> freshwater aquatic habitats are present.
<i>Castilleja affinis</i> <i>var. neglecta</i> Tiburon paintbrush	FE/ST G4G5T1T2/S1S2 1B.2	Perennial herb (hemiparasitic). Valley and foothill grassland. Rocky serpentine sites. Elevations: 195-1310ft. (60-400m.) Blooms Apr-Jun.	<b>Not Expected;</b> suitable vegetation communities are not present.	<b>Not Expected;</b> suitable vegetation communities are not present.	<b>Not Expected;</b> suitable vegetation communities are not present.	<b>Not Expected;</b> suitable vegetation communities are not present.	<b>Not Expected;</b> suitable vegetation communities are not present.	<b>Not Expected;</b> suitable vegetation communities are not present.	<b>Not Expected;</b> suitable vegetation communities are not present.	<b>Not Expected;</b> suitable vegetation communities are not present.	<b>Not Expected;</b> suitable vegetation communities are not present.	<b>Not Expected;</b> suitable vegetation communities are not present.	<b>Not Expected;</b> suitable vegetation communities are not present.

Scientific Name Common Name	Status Fed/ State ESA CRPR	Habitat Requirements	GEY	GUE	LAR	FOR	GRA	SAN	GLE	AGU	PEN	PET	SON
<i>Castilleja ambigua</i> <i>var. humboldtiensis</i> Humboldt Bay owl's-clover	None/None G4T2/S2 1B.2	Annual herb (hemiparasitic). Marshes and swamps. In coastal saltmarsh with <i>Spartina</i> , <i>Distichlis</i> , <i>Salicornia</i> , <i>Jaumea</i> . Elevations: 0-10ft. (0-3m.) Blooms Apr-Aug.	<b>Not Expected;</b> suitable aquatic habitats and vegetation communities are not present	<b>Not Expected;</b> suitable aquatic habitats and vegetation communities are not present	<b>Not Expected;</b> suitable aquatic habitats and vegetation communities are not present	<b>Not Expected;</b> suitable aquatic habitats and vegetation communities are not present	<b>Not Expected;</b> suitable aquatic habitats and vegetation communities are not present	<b>Not Expected;</b> suitable aquatic habitats and vegetation communities are not present	<b>Not Expected;</b> suitable aquatic habitats and vegetation communities are not present	<b>Not Expected;</b> suitable aquatic habitats and vegetation communities are not present	<b>Not Expected;</b> suitable aquatic habitats and vegetation communities are not present	<b>Not Expected;</b> suitable aquatic habitats and vegetation communities are not present	<b>Not Expected;</b> suitable aquatic habitats and vegetation communities are not present
<i>Castilleja ambigua</i> <i>var. meadii</i> Mead's owls-clover	None/None G4T1/S1 1B.1	Annual herb (hemiparasitic). Meadows and seeps, vernal pools. Clay, gravelly, volcanic. Elevations: 1475-1560ft. (450-475m.) Blooms Apr-May.	<b>Not Expected;</b> suitable vegetation communities are not present.	<b>Not Expected;</b> suitable vegetation communities are not present.	<b>Not Expected;</b> suitable vegetation communities are not present.	<b>Not Expected;</b> suitable vegetation communities are not present.	<b>Not Expected;</b> suitable vegetation communities are not present.	<b>Not Expected;</b> suitable vegetation communities are not present.	<b>Not Expected;</b> suitable vegetation communities are not present.	<b>Not Expected;</b> suitable vegetation communities are not present.	<b>Not Expected;</b> suitable vegetation communities are not present.	<b>Not Expected;</b> suitable vegetation communities are not present.	<b>Not Expected;</b> suitable vegetation communities are not present.
<i>Castilleja uliginosa</i> Pitkin Marsh paintbrush	None/SE GXQ/SX 1A	Marshes and swamps (freshwater). 240-240 m. perennial herb (hemiparasitic). Blooms Jun-Jul	<b>Not Expected;</b> suitable aquatic habitats and vegetation communities are not present	<b>Moderate Potential;</b> freshwater habitats are present.	<b>Moderate Potential;</b> freshwater habitats are present.	<b>Moderate Potential;</b> freshwater habitats are present.	<b>Moderate Potential;</b> freshwater habitats are present.	<b>Moderate Potential;</b> freshwater habitats are present.	<b>Moderate Potential;</b> freshwater habitats are present.	<b>Moderate Potential;</b> freshwater habitats are present.	<b>Moderate Potential;</b> freshwater habitats are present.	<b>Not Expected;</b> suitable aquatic habitats and vegetation communities are not present	<b>Moderate Potential;</b> freshwater aquatic habitats are present.
<i>Ceanothus confusus</i> Rincon Ridge ceanothus	None/None G1/S1 1B.1	Closed-cone coniferous forest, Chaparral, Cismontane woodland. volcanic or serpentinite. 75-1065 m. perennial evergreen shrub. Blooms Feb-Jun	<b>Low Potential;</b> suitable vegetation communities are present, suitable soils may be present	<b>Low Potential;</b> suitable vegetation communities are present, suitable soils may be present	<b>Low Potential;</b> suitable vegetation communities are present, suitable soils may be present	<b>Low Potential;</b> suitable vegetation communities are present, suitable soils may be present	<b>Low Potential;</b> suitable vegetation communities are present, suitable soils may be present	<b>Low Potential;</b> suitable vegetation communities are present, suitable soils may be present	<b>Low Potential;</b> suitable vegetation communities are present, suitable soils may be present	<b>Low Potential;</b> suitable vegetation communities are present, suitable soils may be present	<b>Low Potential;</b> suitable vegetation communities are present, suitable soils may be present	<b>Low Potential;</b> suitable vegetation communities are present, suitable soils may be present	<b>Low Potential;</b> suitable vegetation communities are present, suitable soils may be present
<i>Ceanothus divergens</i> <i>Calistoga ceanothus</i>	None/None G2/S2 1B.2	Chaparral (serpentinite or volcanic, rocky). 170-950 m. perennial evergreen shrub. Blooms Feb-Apr	<b>Not Expected;</b> suitable vegetation communities are not present.	<b>Not Expected;</b> suitable vegetation communities are not present.	<b>Not Expected;</b> suitable vegetation communities are not present.	<b>Not Expected;</b> suitable vegetation communities are not present.	<b>Not Expected;</b> suitable vegetation communities are not present.	<b>Not Expected;</b> suitable vegetation communities are not present.	<b>Not Expected;</b> suitable vegetation communities are not present.	<b>Not Expected;</b> suitable vegetation communities are not present.	<b>Not Expected;</b> suitable vegetation communities are not present.	<b>Not Expected;</b> suitable vegetation communities are not present.	<b>Not Expected;</b> suitable vegetation communities are not present.
<i>Ceanothus foliosus</i> <i>var. vineatus</i> Vine Hill ceanothus	None/None G3T1/S1 1B.1	Chaparral. 45-305 m. perennialevergreen shrub. Blooms Mar- May	<b>Not Expected;</b> suitable vegetation communities are not present.	<b>Not Expected;</b> suitable vegetation communities are not present.	<b>Not Expected;</b> suitable vegetation communities are not present.	<b>Not Expected;</b> suitable vegetation communities are not present.	<b>Not Expected;</b> suitable vegetation communities are not present.	<b>Not Expected;</b> suitable vegetation communities are not present.	<b>Not Expected;</b> suitable vegetation communities are not present.	<b>Not Expected;</b> suitable vegetation communities are not present.	<b>Not Expected;</b> suitable vegetation communities are not present.	<b>Not Expected;</b> suitable vegetation communities are not present.	<b>Not Expected;</b> suitable vegetation communities are not present.
<i>Ceanothus gloriosus</i> <i>var. porrectus</i> Mt. Vision ceanothus	None/None G4T2/S2 1B.3	Perennial evergreen shrub. Closed-cone coniferous forest, coastal prairie, coastal scrub, valley and foothill grassland. Low shrub in a variety of habitats on Pt. Reyes; sandy soils. Elevations: 80-1000ft. (25-305m.) Blooms Feb-May.	<b>Not Expected;</b> suitable vegetation communities are not present.	<b>Not Expected;</b> suitable vegetation communities are not present.	<b>Not Expected;</b> suitable vegetation communities are not present.	<b>Not Expected;</b> suitable vegetation communities are not present.	<b>Not Expected;</b> suitable vegetation communities are not present.	<b>Not Expected;</b> suitable vegetation communities are not present.	<b>Not Expected;</b> suitable vegetation communities are not present.	<b>Not Expected;</b> suitable vegetation communities are not present.	<b>Not Expected;</b> suitable vegetation communities are not present.	<b>Not Expected;</b> suitable vegetation communities are not present.	<b>Not Expected;</b> suitable vegetation communities are not present.
<i>Ceanothus masonii</i> Mason's ceanothus	None/SR G1/S1 1B.2	Perennial evergreen shrub. Chaparral. Serpentine ridges or slopes in chaparral or transition zone. Elevations: 755-1640ft. (230-500m.) Blooms Mar-Apr.	<b>Not Expected;</b> suitable vegetation communities are not present.	<b>Not Expected;</b> suitable vegetation communities are not present.	<b>Not Expected;</b> suitable vegetation communities are not present.	<b>Not Expected;</b> suitable vegetation communities are not present.	<b>Not Expected;</b> suitable vegetation communities are not present.	<b>Not Expected;</b> suitable vegetation communities are not present.	<b>Not Expected;</b> suitable vegetation communities are not present.	<b>Not Expected;</b> suitable vegetation communities are not present.	<b>Not Expected;</b> suitable vegetation communities are not present.	<b>Not Expected;</b> suitable vegetation communities are not present.	<b>Not Expected;</b> suitable vegetation communities are not present.

Sonoma County  
Rezoning Sites for Housing Project

Scientific Name Common Name	Status Fed/ State ESA CRPR	Habitat Requirements	GEY	GUE	LAR	FOR	GRA	SAN	GLE	AGU	PEN	PET	SON
<i>Ceanothus purpureus</i> holly-leaved ceanothus	None/None G2/S2 1B.2	Chaparral, Cismontane woodland. volcanic, rocky. 120-640 m. perennial evergreen shrub. Blooms Feb-Jun	<b>Low Potential;</b> suitable vegetation communities are present, suitable soils may be present	<b>Present;</b> suitable vegetation communities are present, a presumed extant occurrence is mapped within the BSA.	<b>Low Potential;</b> suitable vegetation communities are present, suitable soils may be present	<b>Low Potential;</b> suitable vegetation communities are present, suitable soils may be present	<b>Low Potential;</b> suitable vegetation communities are present, suitable soils may be present	<b>Low Potential;</b> suitable vegetation communities are present, suitable soils may be present	<b>Low Potential;</b> suitable vegetation communities are present, suitable soils may be present	<b>Low Potential;</b> suitable vegetation communities are present, suitable soils may be present	<b>Low Potential;</b> suitable vegetation communities are present, suitable soils may be present	<b>Low Potential;</b> suitable vegetation communities are present, suitable soils may be present	<b>Low Potential;</b> suitable vegetation communities are present, suitable soils may be present
<i>Ceanothus sonomensis</i> Sonoma ceanothus	None/None G2/S2 1B.2	Chaparral (sandy, serpentinite or volcanic). 215 - 800 m. perennial evergreen shrub. Blooms Feb- Apr	<b>Not Expected;</b> suitable vegetation communities are not present.	<b>Not Expected;</b> suitable vegetation communities are not present.	<b>Not Expected;</b> suitable vegetation communities are not present.	<b>Not Expected;</b> suitable vegetation communities are not present.	<b>Not Expected;</b> suitable vegetation communities are not present.	<b>Not Expected;</b> suitable vegetation communities are not present.	<b>Not Expected;</b> suitable vegetation communities are not present.	<b>Not Expected;</b> suitable vegetation communities are not present.	<b>Not Expected;</b> suitable vegetation communities are not present.	<b>Not Expected;</b> suitable vegetation communities are not present.	<b>Not Expected;</b> suitable vegetation communities are not present.
<i>Centromadia parryi</i> <i>ssp. parryi</i> pappose tarplant	None/None G3T2/S2 1B.2	Chaparral, Coastal prairie, Meadows and seeps, Marshes and swamps (coastal salt), Valley and foothill grassland (vernally mesic). often alkaline. 0-420m. annual herb. Blooms May-Nov	<b>Not Expected;</b> suitable aquatic habitats and vegetation communities are not present	<b>Moderate Potential;</b> freshwater habitats are present.	<b>Moderate Potential;</b> freshwater habitats are present.	<b>Moderate Potential;</b> freshwater habitats are present.	<b>Moderate Potential;</b> freshwater habitats are present.	<b>Moderate Potential;</b> freshwater habitats are present.	<b>Moderate Potential;</b> freshwater habitats are present.	<b>Moderate Potential;</b> freshwater habitats are present.	<b>Present; A</b> presumed extant occurrence is mapped within the BSA.	<b>Not Expected;</b> suitable aquatic habitats and vegetation communities are not present	<b>Moderate Potential;</b> freshwater aquatic habitats are present.
<i>Chlorogalum pomeridianum</i> <i>var. minus</i> dwarf soaproot	None/None G5T3/S3 1B.2	Chaparral (serpentinite). 305-1000 m. perennial bulbiferous herb. Blooms May-Aug	<b>Not Expected;</b> suitable vegetation communities are not present.	<b>Not Expected;</b> suitable vegetation communities are not present.	<b>Not Expected;</b> suitable vegetation communities are not present.	<b>Not Expected;</b> suitable vegetation communities are not present.	<b>Not Expected;</b> suitable vegetation communities are not present.	<b>Not Expected;</b> suitable vegetation communities are not present.	<b>Not Expected;</b> suitable vegetation communities are not present.	<b>Not Expected;</b> suitable vegetation communities are not present.	<b>Not Expected;</b> suitable vegetation communities are not present.	<b>Not Expected;</b> suitable vegetation communities are not present.	<b>Not Expected;</b> suitable vegetation communities are not present.
<i>Chloropyron maritimum</i> <i>ssp. palustre</i> Point Reyes salty bird's-beak	None/None G4T2/S2 1B.2	Marshes and swamps (coastal salt). 0-10 m. annual herb (hemiparasitic). Blooms Jun-Oct	<b>Not Expected;</b> suitable salt marsh habitats are not present	<b>Not Expected;</b> suitable salt marsh habitats are not present	<b>Not Expected;</b> suitable salt marsh habitats are not present	<b>Not Expected;</b> suitable salt marsh habitats are not present	<b>Not Expected;</b> suitable salt marsh habitats are not present	<b>Not Expected;</b> suitable salt marsh habitats are not present	<b>Not Expected;</b> suitable salt marsh habitats are not present	<b>Not Expected;</b> suitable salt marsh habitats are not present	<b>Not Expected;</b> suitable salt marsh habitats are not present	<b>Not Expected;</b> suitable salt marsh habitats are not present	<b>Not Expected;</b> suitable salt marsh habitats are not present
<i>Chloropyron mole</i> <i>ssp. mole</i> soft salty bird's-beak	FE/SR G2T1/S1 1B.2	Marshes and swamps (coastal salt). 0-3 m. annual herb (hemiparasitic). Blooms Jun-Nov	<b>Not Expected;</b> suitable salt marsh habitats are not present	<b>Not Expected;</b> suitable salt marsh habitats are not present	<b>Not Expected;</b> suitable salt marsh habitats are not present	<b>Not Expected;</b> suitable salt marsh habitats are not present	<b>Not Expected;</b> suitable salt marsh habitats are not present	<b>Not Expected;</b> suitable salt marsh habitats are not present	<b>Not Expected;</b> suitable salt marsh habitats are not present	<b>Not Expected;</b> suitable salt marsh habitats are not present	<b>Not Expected;</b> suitable salt marsh habitats are not present	<b>Not Expected;</b> suitable salt marsh habitats are not present	<b>Not Expected;</b> suitable salt marsh habitats are not present
<i>Chorizanthe cuspidata</i> <i>var. cuspidata</i> San Francisco Bay spineflower	None/None G2T1/S1 1B.2	Coastal bluff scrub, Coastal dunes, Coastal prairie, Coastal scrub. sandy. 3-215m. annual herb. Blooms Apr-Jul (Aug)	<b>Not Expected;</b> suitable coastal dune habitats are not present.	<b>Not Expected;</b> suitable coastal dune habitats are not present.	<b>Not Expected;</b> suitable coastal dune habitats are not present.	<b>Not Expected;</b> suitable coastal dune habitats are not present.	<b>Not Expected;</b> suitable coastal dune habitats are not present.	<b>Not Expected;</b> suitable coastal dune habitats are not present.	<b>Not Expected;</b> suitable coastal dune habitats are not present.	<b>Not Expected;</b> suitable coastal dune habitats are not present.	<b>Not Expected;</b> suitable coastal dune habitats are not present.	<b>Not Expected;</b> suitable coastal dune habitats are not present.	<b>Not Expected;</b> suitable coastal dune habitats are not present.
<i>Chorizanthe cuspidata</i> <i>var. villosa</i> woolly-headed spineflower	None/None G2T2/S2 1B.2	Coastal dunes, Coastal prairie, Coastal scrub. sandy. 3-60 m. annual herb. Blooms May-Jul (Aug)	<b>Not Expected;</b> suitable coastal dune habitats are not present.	<b>Not Expected;</b> suitable coastal dune habitats are not present.	<b>Not Expected;</b> suitable coastal dune habitats are not present.	<b>Not Expected;</b> suitable coastal dune habitats are not present.	<b>Not Expected;</b> suitable coastal dune habitats are not present.	<b>Not Expected;</b> suitable coastal dune habitats are not present.	<b>Not Expected;</b> suitable coastal dune habitats are not present.	<b>Not Expected;</b> suitable coastal dune habitats are not present.	<b>Not Expected;</b> suitable coastal dune habitats are not present.	<b>Not Expected;</b> suitable coastal dune habitats are not present.	<b>Not Expected;</b> suitable coastal dune habitats are not present.
<i>Chorizanthe valida</i> Sonoma spineflower	FE/SE G1/S1 1B.1	Coastal prairie (sandy). 10-305m. annual herb. Blooms Jun-Aug	<b>Not Expected;</b> suitable vegetation communities and soils are not present.	<b>Not Expected;</b> suitable vegetation communities and soils are not present.	<b>Not Expected;</b> suitable vegetation communities and soils are not present.	<b>Not Expected;</b> suitable vegetation communities and soils are not present.	<b>Not Expected;</b> suitable vegetation communities and soils are not present.	<b>Not Expected;</b> suitable vegetation communities and soils are not present.	<b>Not Expected;</b> suitable vegetation communities and soils are not present.	<b>Not Expected;</b> suitable vegetation communities and soils are not present.	<b>Not Expected;</b> suitable vegetation communities and soils are not present.	<b>Not Expected;</b> suitable vegetation communities and soils are not present.	<b>Not Expected;</b> suitable vegetation communities and soils are not present.



Scientific Name Common Name	Status Fed/ State ESA CRPR	Habitat Requirements	GEY	GUE	LAR	FOR	GRA	SAN	GLE	AGU	PEN	PET	SON
<i>Cirsium andrewsii</i> Franciscan thistle	None/None G3/S3 1B.2	Broadleafed upland forest, Coastal bluff scrub, Coastal prairie, Coastal scrub. mesic, sometimes serpentinite. 0-150m. perennial herb. Blooms Mar-Jul	<b>Low Potential;</b> suitable vegetation communities are present, suitable soils may be present	<b>Low Potential;</b> suitable vegetation communities are present, suitable soils may be present	<b>Low Potential;</b> suitable vegetation communities are present, suitable soils may be present	<b>Low Potential;</b> suitable vegetation communities are present, suitable soils may be present	<b>Low Potential;</b> suitable vegetation communities are present, suitable soils may be present	<b>Low Potential;</b> suitable vegetation communities are present, suitable soils may be present	<b>Low Potential;</b> suitable vegetation communities are present, suitable soils may be present	<b>Low Potential;</b> suitable vegetation communities are present, suitable soils may be present	<b>Low Potential;</b> suitable vegetation communities are present, suitable soils may be present	<b>Low Potential;</b> suitable vegetation communities are present, suitable soils may be present	<b>Low Potential;</b> suitable vegetation communities are present, suitable soils may be present
<i>Cirsium hydrophilum</i> <i>var. vaseyi</i> Mt. Tamalpais thistle	None/None G2T1/S1 1B.2	Perennial herb. Broadleafed upland forest, chaparral, meadows and seeps. Seeps, serpentinite. Elevations: 785-2035ft. (240-620m.) Blooms May-Aug.	<b>Not Expected;</b> suitable vegetation communities and soils are not present.	<b>Not Expected;</b> suitable vegetation communities and soils are not present.	<b>Not Expected;</b> suitable vegetation communities and soils are not present.	<b>Not Expected;</b> suitable vegetation communities and soils are not present.	<b>Not Expected;</b> suitable vegetation communities and soils are not present.	<b>Not Expected;</b> suitable vegetation communities and soils are not present.	<b>Not Expected;</b> suitable vegetation communities and soils are not present.	<b>Not Expected;</b> suitable vegetation communities and soils are not present.	<b>Not Expected;</b> suitable vegetation communities and soils are not present.	<b>Not Expected;</b> suitable vegetation communities and soils are not present.	<b>Not Expected;</b> suitable vegetation communities and soils are not present.
<i>Clarkia imbricata</i> Vine Hill clarkia	FE/SE G1/S1 1B.1	Chaparral, Valley and foothill grassland. acidic sandy loam. 50-75 m. annual herb. Blooms Jun-Aug	<b>Low Potential;</b> suitable vegetation communities are present, suitable soils may be present	<b>Low Potential;</b> suitable vegetation communities are present, suitable soils may be present	<b>Low Potential;</b> suitable vegetation communities are present, suitable soils may be present	<b>Low Potential;</b> suitable vegetation communities are present, suitable soils may be present	<b>Low Potential;</b> suitable vegetation communities are present, suitable soils may be present	<b>Low Potential;</b> suitable vegetation communities are present, suitable soils may be present	<b>Low Potential;</b> suitable vegetation communities are present, suitable soils may be present	<b>Low Potential;</b> suitable vegetation communities are present, suitable soils may be present	<b>Low Potential;</b> suitable vegetation communities are present, suitable soils may be present	<b>Low Potential;</b> suitable vegetation communities are present, suitable soils may be present	<b>Low Potential;</b> suitable vegetation communities are present, suitable soils may be present
<i>Cordylanthus tenuis</i> <i>ssp. capillaris</i> Pennell's bird's-beak	FE/SR G4G5T1/S1 1B.2	Closed-cone coniferous forest, Chaparral. serpentinite. 45-305m. annual herb (hemiparasitic). Blooms Jun-Sep	<b>Not Expected;</b> suitable vegetation communities are not present.	<b>Not Expected;</b> suitable vegetation communities are not present.	<b>Not Expected;</b> suitable vegetation communities are not present.	<b>Not Expected;</b> suitable vegetation communities are not present.	<b>Not Expected;</b> suitable vegetation communities are not present.	<b>Not Expected;</b> suitable vegetation communities are not present.	<b>Not Expected;</b> suitable vegetation communities are not present.	<b>Not Expected;</b> suitable vegetation communities are not present.	<b>Not Expected;</b> suitable vegetation communities are not present.	<b>Not Expected;</b> suitable vegetation communities are not present.	<b>Not Expected;</b> suitable vegetation communities are not present.
<i>Cryptantha dissita</i> serpentine cryptantha	None/None G2/S2 1B.2	Chaparral (serpentinite). 395-580 m. annual herb. Blooms Apr-Jun	<b>Not Expected;</b> suitable vegetation communities are not present.	<b>Not Expected;</b> suitable vegetation communities are not present.	<b>Not Expected;</b> suitable vegetation communities are not present.	<b>Not Expected;</b> suitable vegetation communities are not present.	<b>Not Expected;</b> suitable vegetation communities are not present.	<b>Not Expected;</b> suitable vegetation communities are not present.	<b>Not Expected;</b> suitable vegetation communities are not present.	<b>Not Expected;</b> suitable vegetation communities are not present.	<b>Not Expected;</b> suitable vegetation communities are not present.	<b>Not Expected;</b> suitable vegetation communities are not present.	<b>Not Expected;</b> suitable vegetation communities are not present.
<i>Cuscuta obtusifloravar.</i> <i>glandulosa</i> Peruvian dodder	None/None G5T4?/SH 2B.2	Marshes and swamps (freshwater). 15-280 m. annualvine (parasitic). Blooms Jul-Oct	<b>Not Expected;</b> suitable aquatic habitats and vegetation communities are not present	<b>Moderate Potential;</b> freshwater habitats are present.	<b>Moderate Potential;</b> freshwater habitats are present.	<b>Moderate Potential;</b> freshwater habitats are present.	<b>Moderate Potential;</b> freshwater habitats are present.	<b>Moderate Potential;</b> freshwater habitats are present.	<b>Moderate Potential;</b> freshwater habitats are present.	<b>Moderate Potential;</b> freshwater habitats are present.	<b>Moderate Potential;</b> freshwater habitats are present.	<b>Moderate Potential;</b> freshwater habitats are present.	<b>Moderate Potential;</b> suitable aquatic habitats and vegetation communities are not present
<i>Cuscuta pacifica var.</i> <i>papillata</i> Mendocino dodder	None/None G5T1/S1 1B.2	Coastal dunes (interdune depressions). 0-50 m. annual vine (parasitic). Blooms (Jun)Jul-Oct	<b>Not Expected;</b> suitable coastal dune habitats are not present.	<b>Not Expected;</b> suitable coastal dune habitats are not present.	<b>Not Expected;</b> suitable coastal dune habitats are not present.	<b>Not Expected;</b> suitable coastal dune habitats are not present.	<b>Not Expected;</b> suitable coastal dune habitats are not present.	<b>Not Expected;</b> suitable coastal dune habitats are not present.	<b>Not Expected;</b> suitable coastal dune habitats are not present.	<b>Not Expected;</b> suitable coastal dune habitats are not present.	<b>Not Expected;</b> suitable coastal dune habitats are not present.	<b>Not Expected;</b> suitable coastal dune habitats are not present.	<b>Not Expected;</b> suitable coastal dune habitats are not present.
<i>Delphinium bakeri</i> Baker's larkspur	FE/SE G1/S1 1B.1	Broadleafed upland forest, Coastal scrub, Valley and foothillgrassland. decomposed shale, often mesic. 80-305 m. perennial herb. Blooms Mar- May	<b>Low Potential;</b> suitable vegetation communities are present, suitable soils may be present	<b>Low Potential;</b> suitable vegetation communities are present, suitable soils may be present	<b>Low Potential;</b> suitable vegetation communities are present, suitable soils may be present	<b>Low Potential;</b> suitable vegetation communities are present, suitable soils may be present	<b>Low Potential;</b> suitable vegetation communities are present, suitable soils may be present	<b>Low Potential;</b> suitable vegetation communities are present, suitable soils may be present	<b>Low Potential;</b> suitable vegetation communities are present, suitable soils may be present	<b>Low Potential;</b> suitable vegetation communities are present, suitable soils may be present	<b>Low Potential;</b> suitable vegetation communities are present, suitable soils may be present	<b>Low Potential;</b> suitable vegetation communities are present, suitable soils may be present	<b>Low Potential;</b> suitable vegetation communities are present, suitable soils may be present

Sonoma County  
Rezoning Sites for Housing Project

Scientific Name Common Name	Status Fed/ State ESA CRPR	Habitat Requirements	GEY	GUE	LAR	FOR	GRA	SAN	GLE	AGU	PEN	PET	SON
<i>Delphinium luteum</i> golden larkspur	FE/SR G1/S1 1B.1	Chaparral, Coastal prairie, Coastal scrub. rocky. 0-100m. perennial herb. Blooms Mar- May	<b>Not Expected;</b> suitable vegetation communities and rocky habitats are not present.	<b>Not Expected;</b> suitable vegetation communities and rocky habitats are not present.	<b>Not Expected;</b> suitable vegetation communities and rocky habitats are not present.	<b>Not Expected;</b> suitable vegetation communities and rocky habitats are not present.	<b>Not Expected;</b> suitable vegetation communities and rocky habitats are not present. A possibly extirpated occurrence is mapped within the BSA.	<b>Not Expected;</b> suitable vegetation communities and rocky habitats are not present.	<b>Not Expected;</b> suitable vegetation communities and rocky habitats are not present.	<b>Not Expected;</b> suitable vegetation communities and rocky habitats are not present.	<b>Not Expected;</b> suitable vegetation communities and rocky habitats are not present.	<b>Not Expected;</b> suitable vegetation communities and rocky habitats are not present.	<b>Not Expected;</b> suitable vegetation communities and rocky habitats are not present.
<i>Dirca occidentalis</i> western leatherwood	None/None G2/S2 1B.2	Broadleaved upland forest, Closed-cone coniferous forest, Chaparral, Cismontane woodland, North Coast coniferous forest, Riparian forest, Riparian woodland. mesic. 25-425 m. perennial deciduous shrub. Blooms Jan- Mar(Apr)	<b>Low Potential;</b> suitable vegetation communities are present, suitable soils may be present	<b>Low Potential;</b> suitable vegetation communities are present, suitable soils may be present	<b>Low Potential;</b> suitable vegetation communities are present, suitable soils may be present	<b>Low Potential;</b> suitable vegetation communities are present, suitable soils may be present	<b>Low Potential;</b> suitable vegetation communities are present, suitable soils may be present	<b>Low Potential;</b> suitable vegetation communities are present, suitable soils may be present	<b>Low Potential;</b> suitable vegetation communities are present, suitable soils may be present	<b>Low Potential;</b> suitable vegetation communities are present, suitable soils may be present	<b>Low Potential;</b> suitable vegetation communities are present, suitable soils may be present	<b>Low Potential;</b> suitable vegetation communities are present, suitable soils may be present	<b>Low Potential;</b> suitable vegetation communities are present, suitable soils may be present
<i>Downingia pusilla</i> dwarf downingia	None/None GU/S2 2B.2	Valley and foothill grassland (mesic), Vernal pools. 1-445m. annual herb. Blooms Mar-May	<b>Not Expected;</b> suitable, vernal pool habitats and vegetation communities are not present.	<b>Not Expected;</b> suitable, vernal pool habitats and vegetation communities are not present.	<b>Not Expected;</b> suitable, vernal pool habitats and vegetation communities are not present.	<b>Not Expected;</b> suitable, vernal pool habitats and vegetation communities are not present.	<b>Not Expected;</b> suitable, vernal pool habitats and vegetation communities are not present.	<b>Moderate Potential;</b> suitable vegetation communities are present.	<b>Not Expected;</b> suitable, vernal pool habitats and vegetation communities are not present.	<b>Not Expected;</b> suitable, vernal pool habitats and vegetation communities are not present.	<b>Moderate Potential;</b> suitable vegetation communities are present.	<b>Not Expected;</b> suitable, vernal pool habitats and vegetation communities are not present.	<b>Not Expected;</b> suitable, vernal pool habitats and vegetation communities are not present.
<i>Entosthodon kochii</i> Koch's cord moss	None/None G1/S1 1B.3	Moss. Cismontane woodland. Moss growing on soil on river banks. Elevations: 590- 3280ft. (180-1000m.)	<b>Not Expected;</b> suitable vegetation communities are not present.	<b>Not Expected;</b> suitable vegetation communities are not present.	<b>Not Expected;</b> suitable vegetation communities are not present.	<b>Not Expected;</b> suitable vegetation communities are not present.	<b>Not Expected;</b> suitable vegetation communities are not present.	<b>Not Expected;</b> suitable vegetation communities are not present.	<b>Not Expected;</b> suitable vegetation communities are not present.	<b>Not Expected;</b> suitable vegetation communities are not present.	<b>Not Expected;</b> suitable vegetation communities are not present.	<b>Not Expected;</b> suitable vegetation communities are not present.	<b>Not Expected;</b> suitable vegetation communities are not present.
<i>Eriastrum brandegeae</i> Brandegee's eriastrum	None/None G1Q/S1 1B.1	Annual herb. Chaparral, cismontane woodland. On barren volcanic soils; often in open areas. Elevations: 1395-2755ft. (425-840m.) Blooms Apr-Aug.	<b>Not Expected;</b> suitable vegetation communities are not present.	<b>Not Expected;</b> suitable vegetation communities are not present.	<b>Not Expected;</b> suitable vegetation communities are not present.	<b>Not Expected;</b> suitable vegetation communities are not present.	<b>Not Expected;</b> suitable vegetation communities are not present.	<b>Not Expected;</b> suitable vegetation communities are not present.	<b>Not Expected;</b> suitable vegetation communities are not present.	<b>Not Expected;</b> suitable vegetation communities are not present.	<b>Not Expected;</b> suitable vegetation communities are not present.	<b>Not Expected;</b> suitable vegetation communities are not present.	<b>Not Expected;</b> suitable vegetation communities are not present.
<i>Erigeron greenei</i> Greene's narrow-leaved daisy	None/None G3/S3 1B.2	Chaparral (serpentinite or volcanic). 80-1005 m. perennial herb. Blooms May- Sep	<b>Not Expected;</b> suitable vegetation communities are not present.	<b>Not Expected;</b> suitable vegetation communities are not present.	<b>Not Expected;</b> suitable vegetation communities are not present.	<b>Not Expected;</b> suitable vegetation communities are not present.	<b>Not Expected;</b> suitable vegetation communities are not present.	<b>Not Expected;</b> suitable vegetation communities are not present.	<b>Not Expected;</b> suitable vegetation communities are not present.	<b>Not Expected;</b> suitable vegetation communities are not present.	<b>Not Expected;</b> suitable vegetation communities are not present.	<b>Not Expected;</b> suitable vegetation communities are not present.	<b>Not Expected;</b> suitable vegetation communities are not present.
<i>Erigeron serpentinus</i> serpentine daisy	None/None G2/S2 1B.3	Chaparral (serpentinite, seeps). 60-670 m. perennial herb. Blooms May-Aug	<b>Not Expected;</b> suitable, wetland habitats and vegetation communities are not present.	<b>Not Expected;</b> suitable, wetland habitats and vegetation communities are not present.	<b>Not Expected;</b> suitable, wetland habitats and vegetation communities are not present.	<b>Not Expected;</b> suitable, wetland habitats and vegetation communities are not present.	<b>Not Expected;</b> suitable, wetland habitats and vegetation communities are not present.	<b>Not Expected;</b> suitable, wetland habitats and vegetation communities are not present.	<b>Not Expected;</b> suitable, wetland habitats and vegetation communities are not present.	<b>Not Expected;</b> suitable, wetland habitats and vegetation communities are not present.	<b>Not Expected;</b> suitable, wetland habitats and vegetation communities are not present.	<b>Not Expected;</b> suitable, wetland habitats and vegetation communities are not present.	<b>Not Expected;</b> suitable, wetland habitats and vegetation communities are not present.
<i>Eriogonum cedrorum</i> Cedarsbuckwheat	None/None G1/S1 1B.3	Closed-cone coniferous forest. serpentinite. 365-550m. perennial herb. Blooms Jun-Sep	<b>Not Expected;</b> suitable vegetation communities are not present.	<b>Not Expected;</b> suitable vegetation communities are not present.	<b>Not Expected;</b> suitable vegetation communities are not present.	<b>Not Expected;</b> suitable vegetation communities are not present.	<b>Not Expected;</b> suitable vegetation communities are not present.	<b>Not Expected;</b> suitable vegetation communities are not present.	<b>Not Expected;</b> suitable vegetation communities are not present.	<b>Not Expected;</b> suitable vegetation communities are not present.	<b>Not Expected;</b> suitable vegetation communities are not present.	<b>Not Expected;</b> suitable vegetation communities are not present.	<b>Not Expected;</b> suitable vegetation communities are not present.

Scientific Name Common Name	Status Fed/ State ESA CRPR	Habitat Requirements	GEY	GUE	LAR	FOR	GRA	SAN	GLE	AGU	PEN	PET	SON
<i>Eriogonum luteolum</i> var. <i>caninum</i> Tiburon buckwheat	None/None G5T2/S2 1B.2	Chaparral, Cismontane woodland, Coastal prairie, Valleyland foothill grassland, serpentinite, sandy to gravelly. 0-700m. annual herb. Blooms May-Sep	<b>Low Potential;</b> suitable vegetation communities are present, suitable soils may be present	<b>Low Potential;</b> suitable vegetation communities are present, suitable soils may be present	<b>Low Potential;</b> suitable vegetation communities are present, suitable soils may be present	<b>Low Potential;</b> suitable vegetation communities are present, suitable soils may be present	<b>Low Potential;</b> suitable vegetation communities are present, suitable soils may be present	<b>Low Potential;</b> suitable vegetation communities are present, suitable soils may be present	<b>Low Potential;</b> suitable vegetation communities are present, suitable soils may be present	<b>Low Potential;</b> suitable vegetation communities are present, suitable soils may be present	<b>Low Potential;</b> suitable vegetation communities are present, suitable soils may be present	<b>Low Potential;</b> suitable vegetation communities are present, suitable soils may be present	<b>Low Potential;</b> suitable vegetation communities are present, suitable soils may be present
<i>Eriogonum nervulosum</i> Snow Mountain buckwheat	None/None G2/S2 1B.2	Chaparral (serpentinite). 300-2105 m. perennial rhizomatous herb. Blooms Jun-Sep	<b>Not Expected;</b> suitable vegetation communities are not present.	<b>Not Expected;</b> suitable vegetation communities are not present.	<b>Not Expected;</b> suitable vegetation communities are not present.	<b>Not Expected;</b> suitable vegetation communities are not present.	<b>Not Expected;</b> suitable vegetation communities are not present.	<b>Not Expected;</b> suitable vegetation communities are not present.	<b>Not Expected;</b> suitable vegetation communities are not present.	<b>Not Expected;</b> suitable vegetation communities are not present.	<b>Not Expected;</b> suitable vegetation communities are not present.	<b>Not Expected;</b> suitable vegetation communities are not present.	<b>Not Expected;</b> suitable vegetation communities are not present.
<i>Eryngium constancei</i> Loch Lomond button-celery	FE/SE G1/S1 1B.1	Vernal pools. 460-855m. annual/perennial herb. Blooms Apr-Jun	<b>Not Expected;</b> suitable, vernal pool habitats and vegetation communities are not present.	<b>Not Expected;</b> suitable, vernal pool habitats and vegetation communities are not present.	<b>Not Expected;</b> suitable, vernal pool habitats and vegetation communities are not present.	<b>Not Expected;</b> suitable, vernal pool habitats and vegetation communities are not present.	<b>Not Expected;</b> suitable, vernal pool habitats and vegetation communities are not present.	<b>Moderate Potential;</b> suitable vegetation communities are present.	<b>Not Expected;</b> suitable, vernal pool habitats and vegetation communities are not present.	<b>Not Expected;</b> suitable, vernal pool habitats and vegetation communities are not present.	<b>Moderate Potential;</b> suitable vegetation communities are present.	<b>Not Expected;</b> suitable, vernal pool habitats and vegetation communities are not present.	<b>Not Expected;</b> suitable, vernal pool habitats and vegetation communities are not present.
<i>Eryngium jepsonii</i> Jepson's coyote-thistle	None/None G2/S2 1B.2	Perennial herb. Valley and foothill grassland, vernal pools. Clay. Elevations: 10-985ft. (3-300m.) Blooms Apr-Aug.	<b>Not Expected;</b> suitable, vernal pool habitats and vegetation communities are not present.	<b>Not Expected;</b> suitable, vernal pool habitats and vegetation communities are not present.	<b>Not Expected;</b> suitable, vernal pool habitats and vegetation communities are not present.	<b>Not Expected;</b> suitable, vernal pool habitats and vegetation communities are not present.	<b>Not Expected;</b> suitable, vernal pool habitats and vegetation communities are not present.	<b>Moderate Potential;</b> suitable vegetation communities are present.	<b>Not Expected;</b> suitable, vernal pool habitats and vegetation communities are not present.	<b>Not Expected;</b> suitable, vernal pool habitats and vegetation communities are not present.	<b>Moderate Potential;</b> suitable vegetation communities are present.	<b>Not Expected;</b> suitable, vernal pool habitats and vegetation communities are not present.	<b>Not Expected;</b> suitable, vernal pool habitats and vegetation communities are not present.
<i>Erysimum concinnum</i> bluff wallflower	None/None G3/S2 1B.2	Coastal bluff scrub, Coastal dunes, Coastal prairie. 0-185m. annual/perennial herb. Blooms Feb-Jul	<b>Not Expected;</b> suitable vegetation communities are not present.	<b>Not Expected;</b> suitable vegetation communities are not present.	<b>Not Expected;</b> suitable vegetation communities are not present.	<b>Not Expected;</b> suitable vegetation communities are not present.	<b>Not Expected;</b> suitable vegetation communities are not present.	<b>Not Expected;</b> suitable vegetation communities are not present.	<b>Not Expected;</b> suitable vegetation communities are not present.	<b>Not Expected;</b> suitable vegetation communities are not present.	<b>Not Expected;</b> suitable vegetation communities are not present.	<b>Not Expected;</b> suitable vegetation communities are not present.	<b>Not Expected;</b> suitable vegetation communities are not present.
<i>Extriplex joaquinana</i> San Joaquin spearscale	None/None G2/S2 1B.2	Annual herb. Chenopod scrub, meadows and seeps, playas, valley and foothill grassland. In seasonal alkali wetlands or alkali sink scrub with <i>Distichlis spicata</i> , <i>Frankenia</i> , etc. Elevations: 5-2740ft. (1-835m.) Blooms Apr-Oct.	<b>Not Expected;</b> suitable, vegetation communities are not present.	<b>Not Expected;</b> suitable, vegetation communities are not present.	<b>Not Expected;</b> suitable, vegetation communities are not present.	<b>Not Expected;</b> suitable, vegetation communities are not present.	<b>Not Expected;</b> suitable, vegetation communities are not present.	<b>Not Expected;</b> suitable, vegetation communities are not present.	<b>Not Expected;</b> suitable, vegetation communities are not present.	<b>Not Expected;</b> suitable, vegetation communities are not present.	<b>Not Expected;</b> suitable, vegetation communities are not present.	<b>Not Expected;</b> suitable, vegetation communities are not present.	<b>Not Expected;</b> suitable, vegetation communities are not present.
<i>Fissidens pauperculus</i> minute pocket moss	None/None G3?/S2 1B.2	North Coast coniferous forest (damp coastal soil). 10-1024m. moss. Blooms	<b>Not Expected;</b> suitable vegetation communities are not present.	<b>Not Expected;</b> suitable vegetation communities are not present.	<b>Not Expected;</b> suitable vegetation communities are not present.	<b>Not Expected;</b> suitable vegetation communities are not present.	<b>Not Expected;</b> suitable vegetation communities are not present.	<b>Not Expected;</b> suitable vegetation communities are not present.	<b>Not Expected;</b> suitable vegetation communities are not present.	<b>Not Expected;</b> suitable vegetation communities are not present.	<b>Not Expected;</b> suitable vegetation communities are not present.	<b>Not Expected;</b> suitable vegetation communities are not present.	<b>Not Expected;</b> suitable vegetation communities are not present.
<i>Fritillaria lanceolata</i> var. <i>tristulis</i> Marin checker lily	None/None G5T2/S2 1B.1	Perennial bulbiferous herb. Coastal bluff scrub, coastal prairie, coastal scrub. Occurrences reported from canyons and riparian areas as well as rock outcrops; often on serpentinite. Elevations: 50-490ft. (15-150m.) Blooms Feb-May.	<b>Not Expected;</b> suitable, vegetation communities are not present.	<b>Not Expected;</b> suitable, vegetation communities are not present.	<b>Not Expected;</b> suitable, vegetation communities are not present.	<b>Not Expected;</b> suitable, vegetation communities are not present.	<b>Not Expected;</b> suitable, vegetation communities are not present.	<b>Not Expected;</b> suitable, vegetation communities are not present.	<b>Not Expected;</b> suitable, vegetation communities are not present.	<b>Not Expected;</b> suitable, vegetation communities are not present.	<b>Not Expected;</b> suitable, vegetation communities are not present.	<b>Not Expected;</b> suitable, vegetation communities are not present.	<b>Not Expected;</b> suitable, vegetation communities are not present.

Sonoma County  
Rezoning Sites for Housing Project

Scientific Name Common Name	Status Fed/ State ESA CRPR	Habitat Requirements	GEY	GUE	LAR	FOR	GRA	SAN	GLE	AGU	PEN	PET	SON
<i>Fritillaria liliacea</i> fragrant fritillary	None/None G2/S2 1B.2	Cismontane woodland, Coastal prairie, Coastal scrub, Valley and foothill grassland. Often serpentine. 3-410 m. perennial bulbiferous herb. Blooms Feb-Apr	<b>Low Potential;</b> suitable vegetation communities are present, suitable soils may be present	<b>Low Potential;</b> suitable vegetation communities are present, suitable soils may be present	<b>Low Potential;</b> suitable vegetation communities are present, suitable soils may be present	<b>Low Potential;</b> suitable vegetation communities are present, suitable soils may be present	<b>Low Potential;</b> suitable vegetation communities are present, suitable soils may be present	<b>Low Potential;</b> suitable vegetation communities are present, suitable soils may be present	<b>Low Potential;</b> suitable vegetation communities are present, suitable soils may be present	<b>Low Potential;</b> suitable vegetation communities are present, suitable soils may be present	<b>Low Potential;</b> suitable vegetation communities are present, suitable soils may be present	<b>Low Potential;</b> suitable vegetation communities are present, suitable soils may be present	<b>Low Potential;</b> suitable vegetation communities are present, suitable soils may be present
<i>Gilia capitata</i> <i>ssp. chamissonis</i> blue coast gilia	None/None G5T2/S2 1B.1	Coastal dunes, Coastal scrub. 2-200m. annual herb. Blooms Apr-Jul	<b>Not Expected;</b> suitable coastal vegetation communities are not present.	<b>Not Expected;</b> suitable coastal vegetation communities are not present.	<b>Not Expected;</b> suitable coastal vegetation communities are not present.	<b>Not Expected;</b> suitable coastal vegetation communities are not present.	<b>Not Expected;</b> suitable coastal vegetation communities are not present.	<b>Not Expected;</b> suitable coastal vegetation communities are not present.	<b>Not Expected;</b> suitable coastal vegetation communities are not present.	<b>Not Expected;</b> suitable coastal vegetation communities are not present.	<b>Not Expected;</b> suitable coastal vegetation communities are not present.	<b>Not Expected;</b> suitable coastal vegetation communities are not present.	<b>Not Expected;</b> suitable coastal vegetation communities are not present.
<i>Gilia capitata</i> <i>ssp. pacifica</i> Pacific gilia	None/None G5T3/S2 1B.2	Coastal bluff scrub, Chaparral (openings), Coastal prairie, Valley and foothill grassland. 5-1665 m. annual herb. Blooms Apr-Aug	<b>Low Potential;</b> suitable vegetation communities are present, suitable soils may be present	<b>Low Potential;</b> suitable vegetation communities are present, suitable soils may be present	<b>Low Potential;</b> suitable vegetation communities are present, suitable soils may be present	<b>Low Potential;</b> suitable vegetation communities are present, suitable soils may be present	<b>Low Potential;</b> suitable vegetation communities are present, suitable soils may be present	<b>Low Potential;</b> suitable vegetation communities are present, suitable soils may be present	<b>Low Potential;</b> suitable vegetation communities are present, suitable soils may be present	<b>Low Potential;</b> suitable vegetation communities are present, suitable soils may be present	<b>Low Potential;</b> suitable vegetation communities are present, suitable soils may be present	<b>Low Potential;</b> suitable vegetation communities are present, suitable soils may be present	<b>Low Potential;</b> suitable vegetation communities are present, suitable soils may be present
<i>Gilia capitata</i> <i>ssp. tomentosa</i> woolly-headed gilia	None/None G5T2/S2 1B.1	Coastal bluff scrub, Valley and foothill grassland. Serpentine, rocky, outcrops. 10-220 m. annual herb. Blooms May-Jul	<b>Not Expected;</b> suitable, wetland habitats and vegetation communities are not present.	<b>Not Expected;</b> suitable, wetland habitats and vegetation communities are not present.	<b>Not Expected;</b> suitable, wetland habitats and vegetation communities are not present.	<b>Not Expected;</b> suitable, wetland habitats and vegetation communities are not present.	<b>Not Expected;</b> suitable, wetland habitats and vegetation communities are not present.	<b>Not Expected;</b> suitable, wetland habitats and vegetation communities are not present.	<b>Not Expected;</b> suitable, wetland habitats and vegetation communities are not present.	<b>Not Expected;</b> suitable, wetland habitats and vegetation communities are not present.	<b>Not Expected;</b> suitable, wetland habitats and vegetation communities are not present.	<b>Not Expected;</b> suitable, wetland habitats and vegetation communities are not present.	<b>Not Expected;</b> suitable, wetland habitats and vegetation communities are not present.
<i>Gilia millefoliata</i> dark-eyed gilia	None/None G2/S2 1B.2	Coastal dunes. 2-30 m. annual herb. Blooms Apr-Jul	<b>Not Expected;</b> coastal dune habitats are not present.	<b>Not Expected;</b> coastal dune habitats are not present.	<b>Not Expected;</b> coastal dune habitats are not present.	<b>Not Expected;</b> coastal dune habitats are not present.	<b>Not Expected;</b> coastal dune habitats are not present.	<b>Not Expected;</b> coastal dune habitats are not present.	<b>Not Expected;</b> coastal dune habitats are not present.	<b>Not Expected;</b> coastal dune habitats are not present.	<b>Not Expected;</b> coastal dune habitats are not present.	<b>Not Expected;</b> coastal dune habitats are not present.	<b>Not Expected;</b> coastal dune habitats are not present.
<i>Gratiola heterosepala</i> Boggs Lake hedge-hyssop	None/SE G2/S2 1B.2	Marshes and swamps (lake margins), Vernal pools. clay. 10 -2375 m. annual herb. Blooms Apr-Aug	<b>Not Expected;</b> suitable aquatic habitats and vegetation communities are not present	<b>Moderate Potential;</b> freshwater habitats are present.	<b>Moderate Potential;</b> freshwater habitats are present.	<b>Moderate Potential;</b> freshwater habitats are present.	<b>Moderate Potential;</b> freshwater habitats are present.	<b>Moderate Potential;</b> freshwater habitats are present.	<b>Moderate Potential;</b> freshwater habitats are present.	<b>Moderate Potential;</b> freshwater habitats are present.	<b>Moderate Potential;</b> freshwater habitats are present.	<b>Not Expected;</b> suitable aquatic habitats and vegetation communities are not present	<b>Moderate Potential;</b> freshwater aquatic habitats are present.
<i>Harmonia hallii</i> Hall's harmonia	None/None G2/S2? 1B.2	Annual herb. Chaparral. Serpentine hills and ridges. Open, rocky areas within chaparral. Elevations: 1000-3200ft. (305-975m.) Blooms (Mar)Apr-Jun.	<b>Not Expected;</b> suitable, vegetation communities are not present.	<b>Not Expected;</b> suitable, vegetation communities are not present.	<b>Not Expected;</b> suitable, vegetation communities are not present.	<b>Not Expected;</b> suitable, vegetation communities are not present.	<b>Not Expected;</b> suitable, vegetation communities are not present.	<b>Not Expected;</b> suitable, vegetation communities are not present.	<b>Not Expected;</b> suitable, vegetation communities are not present.	<b>Not Expected;</b> suitable, vegetation communities are not present.	<b>Not Expected;</b> suitable, vegetation communities are not present.	<b>Not Expected;</b> suitable, vegetation communities are not present.	<b>Not Expected;</b> suitable, vegetation communities are not present.
<i>Hemizonia congesta</i> <i>ssp. congesta</i> congested-headed hayfield tarplant	None/None G5T2/S2 1B.2	Valley and foothill grassland. sometimes roadsides. 20-560m. annual herb. Blooms Apr-Nov	<b>Low Potential;</b> suitable vegetation communities are present, suitable soils may be present	<b>Low Potential;</b> suitable vegetation communities are present, suitable soils may be present	<b>Low Potential;</b> suitable vegetation communities are present, suitable soils may be present	<b>Low Potential;</b> suitable vegetation communities are present, suitable soils may be present	<b>Low Potential;</b> suitable vegetation communities are present, suitable soils may be present	<b>Low Potential;</b> suitable vegetation communities are present, suitable soils may be present	<b>Present; A</b> presumed extant occurrence is mapped within the BSA.	<b>Present; A</b> presumed extant occurrence is mapped within the BSA.	<b>Low Potential;</b> suitable vegetation communities are present, suitable soils may be present	<b>Low Potential;</b> suitable vegetation communities are present, suitable soils may be present	<b>Present; A</b> presumed extant occurrence is mapped within the BSA.
<i>Hesperex sparsiflora</i> var. <i>brevifolia</i> short-leaved evax	None/None G4T3/S2 1B.2	Coastal bluff scrub (sandy), Coastal dunes, Coastal prairie. 0-215 m. annual herb. Blooms Mar-Jun	<b>Not Expected;</b> coastal dune habitats are not present.	<b>Not Expected;</b> coastal dune habitats are not present.	<b>Not Expected;</b> coastal dune habitats are not present.	<b>Not Expected;</b> coastal dune habitats are not present.	<b>Not Expected;</b> coastal dune habitats are not present.	<b>Not Expected;</b> coastal dune habitats are not present.	<b>Not Expected;</b> coastal dune habitats are not present.	<b>Not Expected;</b> coastal dune habitats are not present.	<b>Not Expected;</b> coastal dune habitats are not present.	<b>Not Expected;</b> coastal dune habitats are not present.	<b>Not Expected;</b> coastal dune habitats are not present.

Scientific Name Common Name	Status Fed/ State ESA CRPR	Habitat Requirements	GEY	GUE	LAR	FOR	GRA	SAN	GLE	AGU	PEN	PET	SON
<i>Hesperolinon adenophyllum</i> glandular western flax	None/None G2G3/S2S3 1B.2	Annual herb. Chaparral, cismontane woodland, valley and foothill grassland. Serpentine soils; generally found in serpentine chaparral. Elevations: 490-4315ft. (150-1315m.) Blooms May-Aug.	<b>Not Expected;</b> suitable, vegetation communities are not present.	<b>Not Expected;</b> suitable, vegetation communities are not present.	<b>Not Expected;</b> suitable, vegetation communities are not present.	<b>Not Expected;</b> suitable, vegetation communities are not present.	<b>Not Expected;</b> suitable, vegetation communities are not present.	<b>Not Expected;</b> suitable, vegetation communities are not present.	<b>Not Expected;</b> suitable, vegetation communities are not present.	<b>Not Expected;</b> suitable, vegetation communities are not present.	<b>Not Expected;</b> suitable, vegetation communities are not present.	<b>Not Expected;</b> suitable, vegetation communities are not present.	<b>Not Expected;</b> suitable, vegetation communities are not present.
<i>Hesperolinon bicarpellatum</i> two-carpellate western flax	None/None G2/S2 1B.2	Chaparral (serpentinite). 60 -1005m. annual herb. Blooms May-Jul	<b>Not Expected;</b> suitable, vegetation communities are not present.	<b>Not Expected;</b> suitable, vegetation communities are not present.	<b>Not Expected;</b> suitable, vegetation communities are not present.	<b>Not Expected;</b> suitable, vegetation communities are not present.	<b>Not Expected;</b> suitable, vegetation communities are not present.	<b>Not Expected;</b> suitable, vegetation communities are not present.	<b>Not Expected;</b> suitable, vegetation communities are not present.	<b>Not Expected;</b> suitable, vegetation communities are not present.	<b>Not Expected;</b> suitable, vegetation communities are not present.	<b>Not Expected;</b> suitable, vegetation communities are not present.	<b>Not Expected;</b> suitable, vegetation communities are not present.
<i>Hesperolinon congestum</i> Marin western flax	FT/ST G1/S1 1B.1	Annual herb. Chaparral, valley and foothill grassland. In serpentine barrens and in serpentine grassland and chaparral. Elevations: 15-1215ft. (5-370m.) Blooms Apr-Jul.	<b>Not Expected;</b> suitable, vegetation communities are not present.	<b>Not Expected;</b> suitable, vegetation communities are not present.	<b>Not Expected;</b> suitable, vegetation communities are not present.	<b>Not Expected;</b> suitable, vegetation communities are not present.	<b>Not Expected;</b> suitable, vegetation communities are not present.	<b>Not Expected;</b> suitable, vegetation communities are not present.	<b>Not Expected;</b> suitable, vegetation communities are not present.	<b>Not Expected;</b> suitable, vegetation communities are not present.	<b>Not Expected;</b> suitable, vegetation communities are not present.	<b>Not Expected;</b> suitable, vegetation communities are not present.	<b>Not Expected;</b> suitable, vegetation communities are not present.
<i>Hesperolinon sharsmithiae</i> Sharsmith's western flax	None/None G2Q/S2 1B.2	Annual herb. Chaparral. Serpentine substrates. Elevations: 885-985ft. (270-300m.) Blooms May-Jul.	<b>Not Expected;</b> suitable, vegetation communities are not present.	<b>Not Expected;</b> suitable, vegetation communities are not present.	<b>Not Expected;</b> suitable, vegetation communities are not present.	<b>Not Expected;</b> suitable, vegetation communities are not present.	<b>Not Expected;</b> suitable, vegetation communities are not present.	<b>Not Expected;</b> suitable, vegetation communities are not present.	<b>Not Expected;</b> suitable, vegetation communities are not present.	<b>Not Expected;</b> suitable, vegetation communities are not present.	<b>Not Expected;</b> suitable, vegetation communities are not present.	<b>Not Expected;</b> suitable, vegetation communities are not present.	<b>Not Expected;</b> suitable, vegetation communities are not present.
<i>Heteranthera dubia</i> water star-grass	None/None G5/S2 2B.2	Perennial herb (aquatic). Marshes and swamps. Alkaline, still or slow-moving water. Requires a pH of 7 or higher, usually in slightly eutrophic waters. Elevations: 100-4905ft. (30-1495m.) Blooms Jul-Oct.	<b>Not Expected;</b> suitable, vegetation communities are not present.	<b>Not Expected;</b> suitable, vegetation communities are not present.	<b>Not Expected;</b> suitable, vegetation communities are not present.	<b>Not Expected;</b> suitable, vegetation communities are not present.	<b>Not Expected;</b> suitable, vegetation communities are not present.	<b>Not Expected;</b> suitable, vegetation communities are not present.	<b>Not Expected;</b> suitable, vegetation communities are not present.	<b>Not Expected;</b> suitable, vegetation communities are not present.	<b>Not Expected;</b> suitable, vegetation communities are not present.	<b>Not Expected;</b> suitable, vegetation communities are not present.	<b>Not Expected;</b> suitable, vegetation communities are not present.
<i>Horkelia marinensis</i> Point Reyes horkelia	None/None G2/S2 1B.2	Coastal dunes, Coastal prairie, Coastal scrub. sandy. 5 - 755 m. perennial herb. Blooms May-Sep	<b>Not Expected;</b> coastal dune habitats are not present.	<b>Not Expected;</b> coastal dune habitats are not present.	<b>Not Expected;</b> coastal dune habitats are not present.	<b>Not Expected;</b> coastal dune habitats are not present.	<b>Not Expected;</b> coastal dune habitats are not present.	<b>Not Expected;</b> coastal dune habitats are not present.	<b>Not Expected;</b> coastal dune habitats are not present.	<b>Not Expected;</b> coastal dune habitats are not present.	<b>Not Expected;</b> coastal dune habitats are not present.	<b>Not Expected;</b> coastal dune habitats are not present.	<b>Not Expected;</b> coastal dune habitats are not present.
<i>Horkelia parryi</i> Parry's horkelia	None/None G2/S2 1B.2	Perennial herb. Chaparral, cismontane woodland. Openings in chaparral or woodland; especially known from the lone formation in Amador County. Elevations: 260-3510ft. (80-1070m.) Blooms Apr-Sep.	<b>Low Potential;</b> suitable vegetation communities are present, suitable soils may be present	<b>Low Potential;</b> suitable vegetation communities are present, suitable soils may be present	<b>Low Potential;</b> suitable vegetation communities are present, suitable soils may be present	<b>Low Potential;</b> suitable vegetation communities are present, suitable soils may be present	<b>Low Potential;</b> suitable vegetation communities are present, suitable soils may be present	<b>Low Potential;</b> suitable vegetation communities are present, suitable soils may be present	<b>Low Potential;</b> suitable vegetation communities are present, suitable soils may be present	<b>Low Potential;</b> suitable vegetation communities are present, suitable soils may be present	<b>Low Potential;</b> suitable vegetation communities are present, suitable soils may be present	<b>Low Potential;</b> suitable vegetation communities are present, suitable soils may be present	<b>Low Potential;</b> suitable vegetation communities are present, suitable soils may be present
<i>Horkelia tenuiloba</i> thin-lobed horkelia	None/None G2/S2 1B.2	Broadleafed upland forest, Chaparral, Valley and foothill grassland. mesic openings, sandy. 50-500 m. perennial herb. Blooms May-Jul(Aug)	<b>Not Expected;</b> suitable aquatic habitats and vegetation communities are not present	<b>Moderate Potential;</b> freshwater habitats are present.	<b>Moderate Potential;</b> freshwater habitats are present.	<b>Moderate Potential;</b> freshwater habitats are present.	<b>Moderate Potential;</b> freshwater habitats are present.	<b>Moderate Potential;</b> freshwater habitats are present.	<b>Moderate Potential;</b> freshwater habitats are present.	<b>Moderate Potential;</b> freshwater habitats are present.	<b>Moderate Potential;</b> freshwater habitats are present.	<b>Not Expected;</b> suitable aquatic habitats and vegetation communities are not present	<b>Moderate Potential;</b> freshwater aquatic habitats are present.

Sonoma County  
**Rezone Sites for Housing Project**

Scientific Name Common Name	Status Fed/ State ESA CRPR	Habitat Requirements	GEY	GUE	LAR	FOR	GRA	SAN	GLE	AGU	PEN	PET	SON
<i>Hypogymnia schizidiata</i> island tube lichen	None/None G2G3/S2 1B.3	Foliose lichen. Chaparral, closed-cone coniferous forest. On bark and wood of hardwoods and conifers. Elevations: 1180-1330ft. (360-405m.)	<b>Not Expected;</b> suitable vegetation communities are not present.	<b>Not Expected;</b> suitable vegetation communities are not present.	<b>Not Expected;</b> suitable vegetation communities are not present.	<b>Not Expected;</b> suitable vegetation communities are not present.	<b>Not Expected;</b> suitable vegetation communities are not present.	<b>Not Expected;</b> suitable vegetation communities are not present.	<b>Not Expected;</b> suitable vegetation communities are not present.	<b>Not Expected;</b> suitable vegetation communities are not present.	<b>Not Expected;</b> suitable vegetation communities are not present.	<b>Not Expected;</b> suitable vegetation communities are not present.	<b>Not Expected;</b> suitable vegetation communities are not present.
<i>Kopsiopsis hookeri</i> small groundcone	None/None G4?/S1S2 2B.3	North Coast coniferous forest.90-885 m. perennial rhizomatous herb (parasitic). Blooms Apr-Aug	<b>Not Expected;</b> suitable vegetation communities are not present	<b>Low Potential;</b> suitable vegetation communities are present, suitable soils may be present	<b>Not Expected;</b> suitable vegetation communities are not present	<b>Low Potential;</b> suitable vegetation communities are present, suitable soils may be present	<b>Low Potential;</b> suitable vegetation communities are present, suitable soils may be present	<b>Not Expected;</b> suitable vegetation communities are not present	<b>Not Expected;</b> suitable vegetation communities are not present	<b>Not Expected;</b> suitable vegetation communities are not present	<b>Not Expected;</b> suitable vegetation communities are not present	<b>Not Expected;</b> suitable vegetation communities are not present	<b>Not Expected;</b> suitable vegetation communities are not present
<i>Lasthenia burkei</i> Burke's goldfields	FE/SE G1/S1 1B.1	Meadows and seeps (mesic), Vernal pools. 15-600 m. annualherb. Blooms Apr-Jun	<b>Not Expected;</b> suitable aquatic habitats and vegetation communities are not present	<b>Moderate Potential;</b> freshwater habitats are present.	<b>Moderate Potential;</b> freshwater habitats are present.	<b>Moderate Potential;</b> freshwater habitats are present.	<b>Moderate Potential;</b> freshwater habitats are present.	<b>Moderate Potential;</b> freshwater habitats are present.	<b>Moderate Potential;</b> freshwater habitats are present.	<b>Moderate Potential;</b> freshwater habitats are present.	<b>Moderate Potential;</b> freshwater habitats are present.	<b>Not Expected;</b> suitable aquatic habitats and vegetation communities are not present	<b>Moderate Potential;</b> freshwater aquatic habitatsare present.
<i>Lasthenia californica ssp. bakeri</i> Baker's goldfields	None/None G3T1/S1 1B.2	Closed-cone coniferous forest (openings), Coastal scrub, Meadows and seeps, Marshes and swamps. 60-520m. perennial herb. Blooms Apr-Oct	<b>Not Expected;</b> suitable aquatic habitats and vegetation communities are not present	<b>Moderate Potential;</b> freshwater habitats are present.	<b>Moderate Potential;</b> freshwater habitats are present.	<b>Moderate Potential;</b> freshwater habitats are present.	<b>Moderate Potential;</b> freshwater habitats are present.	<b>Moderate Potential;</b> freshwater habitats are present.	<b>Moderate Potential;</b> freshwater habitats are present.	<b>Moderate Potential;</b> freshwater habitats are present.	<b>Moderate Potential;</b> freshwater habitats are present.	<b>Not Expected;</b> suitable aquatic habitats and vegetation communities are not present	<b>Moderate Potential;</b> freshwater aquatic habitatsare present.
<i>Lasthenia californica ssp. macrantha</i> perennial goldfields	None/None G3T2/S2 1B.2	Coastal bluff scrub, Coastal dunes, Coastal scrub. 5-520m.perennial herb. Blooms Jan-Nov	<b>Not Expected;</b> suitable vegetation communities are not present.	<b>Not Expected;</b> suitable vegetation communities are not present.	<b>Not Expected;</b> suitable vegetation communities are not present.	<b>Not Expected;</b> suitable vegetation communities are not present.	<b>Not Expected;</b> suitable vegetation communities are not present.	<b>Not Expected;</b> suitable vegetation communities are not present.	<b>Not Expected;</b> suitable vegetation communities are not present.	<b>Not Expected;</b> suitable vegetation communities are not present.	<b>Not Expected;</b> suitable vegetation communities are not present.	<b>Not Expected;</b> suitable vegetation communities are not present.	<b>Not Expected;</b> suitable vegetation communities are not present.
<i>Lasthenia conjugens</i> Contra Costa goldfields	FE/None G1/S1 1B.1	Cismontane woodland, Playas (alkaline), Valley and foothill grassland, Vernal pools. mesic. 0-470 m. annual herb. BloomsMar-Jun	<b>Not Expected;</b> suitable aquatic habitats and vegetation communities are not present	<b>Moderate Potential;</b> freshwater habitats are present.	<b>Moderate Potential;</b> freshwater habitats are present.	<b>Moderate Potential;</b> freshwater habitats are present.	<b>Moderate Potential;</b> freshwater habitats are present.	<b>Moderate Potential;</b> freshwater habitats are present.	<b>Moderate Potential;</b> freshwater habitats are present.	<b>Moderate Potential;</b> freshwater habitats are present.	<b>Moderate Potential;</b> freshwater habitats are present.	<b>Not Expected;</b> suitable aquatic habitats and vegetation communities are not present	<b>Moderate Potential;</b> freshwater aquatic habitatsare present.
<i>Lathyrus jepsonii</i> <del>v. jepsonii</del> Delta tule pea	None/None G5T2/S2 1B.2	Marshes and swamps (freshwater and brackish). 0-5m. perennial herb. Blooms May-Jul(Aug-Sep)	<b>Not Expected;</b> suitable aquatic habitats and vegetation communities are not present	<b>Moderate Potential;</b> freshwater habitats are present.	<b>Moderate Potential;</b> freshwater habitats are present.	<b>Moderate Potential;</b> freshwater habitats are present.	<b>Moderate Potential;</b> freshwater habitats are present.	<b>Moderate Potential;</b> freshwater habitats are present.	<b>Moderate Potential;</b> freshwater habitats are present.	<b>Moderate Potential;</b> freshwater habitats are present.	<b>Moderate Potential;</b> freshwater habitats are present.	<b>Not Expected;</b> suitable aquatic habitats and vegetation communities are not present	<b>Moderate Potential;</b> freshwater aquatic habitatsare present.
<i>Lathyrus palustris</i> marsh pea	None/None G5/S2 2B.2	Bogs and fens, Coastal prairie, Coastal scrub, Lower montane coniferous forest, Marshes and swamps, North Coast coniferousforest. mesic. 1-100 m. perennial herb. Blooms Mar-Aug	<b>Not Expected;</b> suitable aquatic habitats and vegetation communities are not present	<b>Moderate Potential;</b> freshwater habitats are present.	<b>Moderate Potential;</b> freshwater habitats are present.	<b>Moderate Potential;</b> freshwater habitats are present.	<b>Moderate Potential;</b> freshwater habitats are present.	<b>Moderate Potential;</b> freshwater habitats are present.	<b>Moderate Potential;</b> freshwater habitats are present.	<b>Moderate Potential;</b> freshwater habitats are present.	<b>Moderate Potential;</b> freshwater habitats are present.	<b>Not Expected;</b> suitable aquatic habitats and vegetation communities are not present	<b>Moderate Potential;</b> freshwater aquatic habitatsare present.

Scientific Name Common Name	Status Fed/ State ESA CRPR	Habitat Requirements	GEY	GUE	LAR	FOR	GRA	SAN	GLE	AGU	PEN	PET	SON
<i>Layia septentrionalis</i> Colusa layia	None/None G2/S2 1B.2	Chaparral, Cismontane woodland, Valley and foothill grassland. sandy, serpentinite. 100-1095 m. annual herb. Blooms Apr-May	<b>Not Expected;</b> suitable vegetation communities and soils are not present.	<b>Not Expected;</b> suitable vegetation communities and soils are not present.	<b>Not Expected;</b> suitable vegetation communities and soils are not present.	<b>Not Expected;</b> suitable vegetation communities and soils are not present.	<b>Not Expected;</b> suitable vegetation communities and soils are not present.	<b>Not Expected;</b> suitable vegetation communities and soils are not present.	<b>Not Expected;</b> suitable vegetation communities and soils are not present.	<b>Not Expected;</b> suitable vegetation communities and soils are not present.	<b>Not Expected;</b> suitable vegetation communities and soils are not present.	<b>Not Expected;</b> suitable vegetation communities and soils are not present.	<b>Not Expected;</b> suitable vegetation communities and soils are not present.
<i>Legenere limosa</i> legenere	None/None G2/S2 1B.1	Vernal pools. 1-880 m. annual herb. Blooms Apr-Jun	<b>Not Expected;</b> suitable, vernal pool habitats and vegetation communities are not present.	<b>Not Expected;</b> suitable, vernal pool habitats and vegetation communities are not present.	<b>Not Expected;</b> suitable, vernal pool habitats and vegetation communities are not present.	<b>Not Expected;</b> suitable, vernal pool habitats and vegetation communities are not present.	<b>Not Expected;</b> suitable, vernal pool habitats and vegetation communities are not present.	<b>Moderate Potential;</b> suitable vegetation communities are present.	<b>Not Expected;</b> suitable, vernal pool habitats and vegetation communities are not present.	<b>Not Expected;</b> suitable, vernal pool habitats and vegetation communities are not present.	<b>Moderate Potential;</b> suitable vegetation communities are present.	<b>Not Expected;</b> suitable, vernal pool habitats and vegetation communities are not present.	<b>Not Expected;</b> suitable, vernal pool habitats and vegetation communities are not present.
<i>Leptosiphon jepsonii</i> Jepson's leptosiphon	None/None G2G3/S2S3 1B.2	Chaparral, Cismontane woodland, Valley and foothill grassland. usually volcanic. 100 -500 m. annual herb. Blooms Mar-May	<b>Low Potential;</b> suitable vegetation communities are present, suitable soils may be present	<b>Low Potential;</b> suitable vegetation communities are present, suitable soils may be present	<b>Low Potential;</b> suitable vegetation communities are present, suitable soils may be present	<b>Low Potential;</b> suitable vegetation communities are present, suitable soils may be present	<b>Low Potential;</b> suitable vegetation communities are present, suitable soils may be present	<b>Low Potential;</b> suitable vegetation communities are present, suitable soils may be present	<b>Low Potential;</b> suitable vegetation communities are present, suitable soils may be present	<b>Low Potential;</b> suitable vegetation communities are present, suitable soils may be present	<b>Low Potential;</b> suitable vegetation communities are present, suitable soils may be present	<b>Low Potential;</b> suitable vegetation communities are present, suitable soils may be present	<b>Low Potential;</b> suitable vegetation communities are present, suitable soils may be present
<i>Leptosiphon rosaceus</i> rose leptosiphon	None/None G1/S1 1B.1	Coastal bluff scrub. 0-100 m. annual herb. Blooms Apr-Jul	<b>Not Expected;</b> suitable vegetation communities are not present.	<b>Not Expected;</b> suitable vegetation communities are not present.	<b>Not Expected;</b> suitable vegetation communities are not present.	<b>Not Expected;</b> suitable vegetation communities are not present.	<b>Not Expected;</b> suitable vegetation communities are not present.	<b>Not Expected;</b> suitable vegetation communities are not present.	<b>Not Expected;</b> suitable vegetation communities are not present.	<b>Not Expected;</b> suitable vegetation communities are not present.	<b>Not Expected;</b> suitable vegetation communities are not present.	<b>Not Expected;</b> suitable vegetation communities are not present.	<b>Not Expected;</b> suitable vegetation communities are not present.
<i>Lessingia arachnoidea</i> Crystal Springs lessingia	None/None G2/S2 1B.2	Cismontane woodland, Coastal scrub, Valley and foothill grassland. serpentinite, often roadsides. 60-200m. annual herb. Blooms Jul-Oct	<b>Low Potential;</b> suitable vegetation communities are present, suitable soils may be present	<b>Low Potential;</b> suitable vegetation communities are present, suitable soils may be present	<b>Low Potential;</b> suitable vegetation communities are present, suitable soils may be present	<b>Low Potential;</b> suitable vegetation communities are present, suitable soils may be present	<b>Low Potential;</b> suitable vegetation communities are present, suitable soils may be present	<b>Low Potential;</b> suitable vegetation communities are present, suitable soils may be present	<b>Low Potential;</b> suitable vegetation communities are present, suitable soils may be present	<b>Low Potential;</b> suitable vegetation communities are present, suitable soils may be present	<b>Low Potential;</b> suitable vegetation communities are present, suitable soils may be present	<b>Low Potential;</b> suitable vegetation communities are present, suitable soils may be present	<b>Low Potential;</b> suitable vegetation communities are present, suitable soils may be present
<i>Lessingia micradenia</i> var. <i>micradenia</i> Tamalpais lessingia	None/None G2T2/S2 1B.2	Annual herb. Chaparral, valley and foothill grassland. Usually on serpentine, in serpentine grassland or serpentine chaparral. Often on roadsides. Elevations: 330-1640ft. (100-500m.) Blooms (Jun)Jul-Oct.	<b>Low Potential;</b> suitable vegetation communities are present, suitable soils may be present	<b>Low Potential;</b> suitable vegetation communities are present, suitable soils may be present	<b>Low Potential;</b> suitable vegetation communities are present, suitable soils may be present	<b>Low Potential;</b> suitable vegetation communities are present, suitable soils may be present	<b>Low Potential;</b> suitable vegetation communities are present, suitable soils may be present	<b>Low Potential;</b> suitable vegetation communities are present, suitable soils may be present	<b>Low Potential;</b> suitable vegetation communities are present, suitable soils may be present	<b>Low Potential;</b> suitable vegetation communities are present, suitable soils may be present	<b>Low Potential;</b> suitable vegetation communities are present, suitable soils may be present	<b>Low Potential;</b> suitable vegetation communities are present, suitable soils may be present	<b>Low Potential;</b> suitable vegetation communities are present, suitable soils may be present
<i>Lilaeopsis masonii</i> Mason's lilaeopsis	None/SR G2/S2 1B.1	Perennial rhizomatous herb. Marshes and swamps, riparian scrub. Tidal zones, in muddy or silty soil formed through river deposition or river bank erosion. In brackish or freshwater. Elevations: 0-35ft. (0-10m.) Blooms Apr-Nov.	<b>Low Potential;</b> suitable vegetation communities are present, suitable soils may be present	<b>Low Potential;</b> suitable vegetation communities are present, suitable soils may be present	<b>Low Potential;</b> suitable vegetation communities are present, suitable soils may be present	<b>Low Potential;</b> suitable vegetation communities are present, suitable soils may be present	<b>Low Potential;</b> suitable vegetation communities are present, suitable soils may be present	<b>Low Potential;</b> suitable vegetation communities are present, suitable soils may be present	<b>Low Potential;</b> suitable vegetation communities are present, suitable soils may be present	<b>Low Potential;</b> suitable vegetation communities are present, suitable soils may be present	<b>Low Potential;</b> suitable vegetation communities are present, suitable soils may be present	<b>Low Potential;</b> suitable vegetation communities are present, suitable soils may be present	<b>Low Potential;</b> suitable vegetation communities are present, suitable soils may be present

Sonoma County  
Rezone Sites for Housing Project

Scientific Name Common Name	Status Fed/ State ESA CRPR	Habitat Requirements	GEY	GUE	LAR	FOR	GRA	SAN	GLE	AGU	PEN	PET	SON
<i>Lilium maritimum</i> coast lily	None/None G2/S2 1B.1	Broadleafed upland forest, Closed-cone coniferous forest, Coastal prairie, Coastal scrub, Marshes and swamps (freshwater), North Coast coniferous forest. sometimes roadside. 5 - 475 m. perennial bulbiferous herb. Blooms May-Aug	<b>Not Expected;</b> suitable aquatic habitats and vegetation communities are not present	<b>Moderate Potential;</b> freshwater habitats are present.	<b>Moderate Potential;</b> freshwater habitats are present.	<b>Moderate Potential;</b> freshwater habitats are present.	<b>Moderate Potential;</b> freshwater habitats are present.	<b>Moderate Potential;</b> freshwater habitats are present.	<b>Moderate Potential;</b> freshwater habitats are present.	<b>Moderate Potential;</b> freshwater habitats are present.	<b>Moderate Potential;</b> freshwater habitats are present.	<b>Not Expected;</b> suitable aquatic habitats and vegetation communities are not present	<b>Moderate Potential;</b> freshwater aquatic habitats are present.
<i>Lilium pardalinum ssp. pitkinense</i> Pitkin Marsh lily	FE/SE G5T1/S1 1B.1	Cismontane woodland, Meadows and seeps, Marshes and swamps (freshwater). mesic, sandy. 35-65 m. perennial bulbiferous herb. Blooms Jun-Jul	<b>Not Expected;</b> suitable aquatic habitats and vegetation communities are not present	<b>Moderate Potential;</b> freshwater habitats are present.	<b>Moderate Potential;</b> freshwater habitats are present.	<b>Moderate Potential;</b> freshwater habitats are present.	<b>Moderate Potential;</b> freshwater habitats are present.	<b>Moderate Potential;</b> freshwater habitats are present.	<b>Moderate Potential;</b> freshwater habitats are present.	<b>Moderate Potential;</b> freshwater habitats are present.	<b>Moderate Potential;</b> freshwater habitats are present.	<b>Not Expected;</b> suitable aquatic habitats and vegetation communities are not present	<b>Moderate Potential;</b> freshwater aquatic habitats are present.
<i>Limnanthes vinculans</i> Sebastopol meadowfoam	FE/SE G1/S1 1B.1	Meadows and seeps, Valley and foothill grassland, Vernal pools. vernal mesic. 15-305m. annual herb. Blooms Apr-May	<b>Not Expected;</b> suitable, vernal pool habitats and vegetation communities are not present.	<b>Not Expected;</b> suitable, vernal pool habitats and vegetation communities are not present.	<b>Not Expected;</b> suitable, vernal pool habitats and vegetation communities are not present.	<b>Not Expected;</b> suitable, vernal pool habitats and vegetation communities are not present.	<b>Not Expected;</b> suitable, vernal pool habitats and vegetation communities are not present.	<b>Moderate Potential;</b> suitable vegetation communities are present.	<b>Not Expected;</b> suitable, vernal pool habitats and vegetation communities are not present.	<b>Not Expected;</b> suitable, vernal pool habitats and vegetation communities are not present.	<b>Moderate Potential;</b> suitable vegetation communities are present.	<b>Not Expected;</b> suitable, vernal pool habitats and vegetation communities are not present.	<b>Not Expected;</b> suitable, vernal pool habitats and vegetation communities are not present.
<i>Lomatium repostum</i> Napa lomatium	None/None G2G3/S2S3 1B.2	Perennial herb. Chaparral, cismontane woodland. Rocky areas in volcanic and serpentine soils with mixed chaparral and black oak woodland communities. Elevations: 295-3380ft. (90-1030m.) Blooms Mar-Jun.	<b>Not Expected;</b> suitable vegetation communities are not present.	<b>Not Expected;</b> suitable vegetation communities are not present.	<b>Not Expected;</b> suitable vegetation communities are not present.	<b>Not Expected;</b> suitable vegetation communities are not present.	<b>Not Expected;</b> suitable vegetation communities are not present.	<b>Not Expected;</b> suitable vegetation communities are not present.	<b>Not Expected;</b> suitable vegetation communities are not present.	<b>Not Expected;</b> suitable vegetation communities are not present.	<b>Not Expected;</b> suitable vegetation communities are not present.	<b>Not Expected;</b> suitable vegetation communities are not present.	<b>Not Expected;</b> suitable vegetation communities are not present.
<i>Lupinus sericatus</i> Cobb Mountain lupine	None/None G2/S2? 1B.2	Broadleafed upland forest, Chaparral, Cismontane woodland, Lower montane coniferous forest. 275 - 1525 m. perennial herb. Blooms Mar-Jun	<b>Not Expected;</b> suitable vegetation communities are not present.	<b>Not Expected;</b> suitable vegetation communities are not present.	<b>Not Expected;</b> suitable vegetation communities are not present.	<b>Not Expected;</b> suitable vegetation communities are not present.	<b>Not Expected;</b> suitable vegetation communities are not present.	<b>Not Expected;</b> suitable vegetation communities are not present.	<b>Not Expected;</b> suitable vegetation communities are not present.	<b>Not Expected;</b> suitable vegetation communities are not present.	<b>Not Expected;</b> suitable vegetation communities are not present.	<b>Not Expected;</b> suitable vegetation communities are not present.	<b>Not Expected;</b> suitable vegetation communities are not present.
<i>Lupinus tidestromii</i> Tidestrom's lupine	FE/SE G1/S1 1B.1	Coastal dunes. 0 - 100 m. perennial rhizomatous herb. Blooms Apr-Jun	<b>Not Expected;</b> suitable vegetation communities are not present.	<b>Not Expected;</b> suitable vegetation communities are not present.	<b>Not Expected;</b> suitable vegetation communities are not present.	<b>Not Expected;</b> suitable vegetation communities are not present.	<b>Not Expected;</b> suitable vegetation communities are not present.	<b>Not Expected;</b> suitable vegetation communities are not present.	<b>Not Expected;</b> suitable vegetation communities are not present.	<b>Not Expected;</b> suitable vegetation communities are not present.	<b>Not Expected;</b> suitable vegetation communities are not present.	<b>Not Expected;</b> suitable vegetation communities are not present.	<b>Not Expected;</b> suitable vegetation communities are not present.
<i>Microseris paludosa</i> marsh microseris	None/None G2/S2 1B.2	Closed-cone coniferous forest, Cismontane woodland, Coastal scrub, Valley and foothill grassland. 5-355m. perennial herb. Blooms Apr-Jun (Jul)	<b>Not Expected;</b> suitable vegetation communities are not present.	<b>Not Expected;</b> suitable vegetation communities are not present.	<b>Not Expected;</b> suitable vegetation communities are not present.	<b>Not Expected;</b> suitable vegetation communities are not present.	<b>Not Expected;</b> suitable vegetation communities are not present.	<b>Not Expected;</b> suitable vegetation communities are not present.	<b>Not Expected;</b> suitable vegetation communities are not present.	<b>Not Expected;</b> suitable vegetation communities are not present.	<b>Not Expected;</b> suitable vegetation communities are not present.	<b>Not Expected;</b> suitable vegetation communities are not present.	<b>Not Expected;</b> suitable vegetation communities are not present.
<i>Navarretia leucocephala ssp. bakeri</i> Baker's navarretia	None/None G4T2/S2 1B.1	Cismontane woodland, Lower montane coniferous forest, Meadows and seeps, Valley and foothill grassland, Vernal pools. Mesic. 5-1740m. annual herb. Blooms Apr-Jul	<b>Low Potential;</b> suitable upland habitats and vegetation communities are present	<b>Moderate Potential;</b> freshwater habitats are present.	<b>Moderate Potential;</b> freshwater habitats are present.	<b>Moderate Potential;</b> freshwater habitats are present.	<b>Moderate Potential;</b> freshwater habitats are present.	<b>Moderate Potential;</b> freshwater habitats are present.	<b>Moderate Potential;</b> freshwater habitats are present.	<b>Moderate Potential;</b> freshwater habitats are present.	<b>Moderate Potential;</b> freshwater habitats are present.	<b>Low Potential;</b> suitable upland habitats and vegetation communities are present	<b>Low Potential;</b> suitable upland habitats and vegetation communities are present



Scientific Name Common Name	Status Fed/ State ESA CRPR	Habitat Requirements	GEY	GUE	LAR	FOR	GRA	SAN	GLE	AGU	PEN	PET	SON
<i>Navarretia leucocephala</i> <i>ssp. pauciflora</i> few-flowered navarretia	FE/ST G4T1/S1 1B.1	Annual herb. Vernal pools. Volcanic ash flow, and volcanic substrate vernal pools. Elevations: 1310-2805ft. (400-855m.) Blooms May-Jun.	<b>Not Expected;</b> suitable, vernal pool habitats and vegetation communities are not present.	<b>Not Expected;</b> suitable, vernal pool habitats and vegetation communities are not present.	<b>Not Expected;</b> suitable, vernal pool habitats and vegetation communities are not present.	<b>Not Expected;</b> suitable, vernal pool habitats and vegetation communities are not present.	<b>Not Expected;</b> suitable, vernal pool habitats and vegetation communities are not present.	<b>Moderate Potential;</b> suitable vegetation communities are present.	<b>Not Expected;</b> suitable, vernal pool habitats and vegetation communities are not present.	<b>Not Expected;</b> suitable, vernal pool habitats and vegetation communities are not present.	<b>Moderate Potential;</b> suitable vegetation communities are present.	<b>Not Expected;</b> suitable, vernal pool habitats and vegetation communities are not present.	<b>Not Expected;</b> suitable, vernal pool habitats and vegetation communities are not present.
<i>Navarretia leucocephala</i> <i>ssp. plieantha</i> many-flowered navarretia	FE/SE G4T1/S1 1B.2	Vernal pools (volcanic ash flow). 30-950m. annual herb. Blooms May-Jun	<b>Not Expected;</b> suitable, vernal pool habitats and vegetation communities are not present.	<b>Not Expected;</b> suitable, vernal pool habitats and vegetation communities are not present.	<b>Not Expected;</b> suitable, vernal pool habitats and vegetation communities are not present.	<b>Not Expected;</b> suitable, vernal pool habitats and vegetation communities are not present.	<b>Not Expected;</b> suitable, vernal pool habitats and vegetation communities are not present.	<b>Moderate Potential;</b> suitable vegetation communities are present.	<b>Not Expected;</b> suitable, vernal pool habitats and vegetation communities are not present.	<b>Not Expected;</b> suitable, vernal pool habitats and vegetation communities are not present.	<b>Moderate Potential;</b> suitable vegetation communities are present.	<b>Not Expected;</b> suitable, vernal pool habitats and vegetation communities are not present.	<b>Not Expected;</b> suitable, vernal pool habitats and vegetation communities are not present.
<i>Navarretia rosulata</i> <i>Marin County navarretia</i>	None/None G2/S2 1B.2	Annual herb. Chaparral, closed-cone coniferous forest. Dry, open rocky places; can occur on serpentine. Elevations: 655-2085ft. (200-635m.) Blooms May-Jul.	<b>Not Expected;</b> suitable vegetation communities are not present.	<b>Not Expected;</b> suitable vegetation communities are not present.	<b>Not Expected;</b> suitable vegetation communities are not present.	<b>Not Expected;</b> suitable vegetation communities are not present.	<b>Not Expected;</b> suitable vegetation communities are not present.	<b>Not Expected;</b> suitable vegetation communities are not present.	<b>Not Expected;</b> suitable vegetation communities are not present.	<b>Not Expected;</b> suitable vegetation communities are not present.	<b>Not Expected;</b> suitable vegetation communities are not present.	<b>Not Expected;</b> suitable vegetation communities are not present.	<b>Not Expected;</b> suitable vegetation communities are not present.
<i>Panicum acuminatum</i> <i>var. thermale</i> Geysers panicum	None/SE G5T2Q/S2 1B.2	Closed-cone coniferous forest, Riparian forest, Valley and foothill grassland. geothermally-altered soil, sometimes streamsides. 305-2470 m. annual/perennial herb. Blooms Jun-Aug	<b>Low Potential;</b> suitable upland habitats and vegetation communities are present.	<b>Moderate Potential;</b> Riparian and grassland habitats are present.	<b>Moderate Potential;</b> Riparian and grassland habitats are present.	<b>Moderate Potential;</b> Riparian and grassland habitats are present.	<b>Moderate Potential;</b> Riparian and grassland habitats are present.	<b>Moderate Potential;</b> Riparian and grassland habitats are present.	<b>Moderate Potential;</b> Riparian and grassland habitats are present.	<b>Moderate Potential;</b> Riparian and grassland habitats are present.	<b>Moderate Potential;</b> Riparian and grassland habitats are present.	<b>Low Potential;</b> suitable upland habitats and vegetation communities are present	<b>Low Potential;</b> suitable upland habitats and vegetation communities are present
<i>Penstemon newberryi</i> <i>var. sonomensis</i> Sonoma beardtongue	None/None G4T3/S3 1B.3	Chaparral (rocky). 700-1370m. perennial herb. Blooms Apr-Aug	<b>Not Expected;</b> suitable rocky habitats are not present.	<b>Not Expected;</b> suitable rocky habitats are not present.	<b>Not Expected;</b> suitable rocky habitats are not present.	<b>Not Expected;</b> suitable rocky habitats are not present.	<b>Not Expected;</b> suitable rocky habitats are not present.	<b>Not Expected;</b> suitable rocky habitats are not present.	<b>Not Expected;</b> suitable rocky habitats are not present.	<b>Not Expected;</b> suitable rocky habitats are not present.	<b>Not Expected;</b> suitable rocky habitats are not present.	<b>Not Expected;</b> suitable rocky habitats are not present.	<b>Not Expected;</b> suitable rocky habitats are not present.
<i>Phacelia insularis</i> <i>var. continentis</i> North Coast phacelia	None/None G2T2/S2 1B.2	Annual herb. Coastal bluff scrub, coastal dunes. Open maritime bluffs, sandy soil, sometimes rocky habitats. Elevations: 35-560ft. (10-170m.) Blooms Mar-May.	<b>Not Expected;</b> suitable vegetation communities are not present.	<b>Not Expected;</b> suitable vegetation communities are not present.	<b>Not Expected;</b> suitable vegetation communities are not present.	<b>Not Expected;</b> suitable vegetation communities are not present.	<b>Not Expected;</b> suitable vegetation communities are not present.	<b>Not Expected;</b> suitable vegetation communities are not present.	<b>Not Expected;</b> suitable vegetation communities are not present.	<b>Not Expected;</b> suitable vegetation communities are not present.	<b>Not Expected;</b> suitable vegetation communities are not present.	<b>Not Expected;</b> suitable vegetation communities are not present.	<b>Not Expected;</b> suitable vegetation communities are not present.
<i>Piperia candida</i> white-flowered reinorchid	None/None G3?/S3 1B.2	Broadleafed upland forest, Lower montane coniferous forest, North Coast coniferous forest. sometimes serpentine. 30-1310 m. perennial herb. Blooms (Mar) May-Sep	<b>Low Potential;</b> suitable upland habitats and vegetation communities are present.	<b>Low Potential;</b> suitable upland habitats and vegetation communities are present	<b>Low Potential;</b> suitable upland habitats and vegetation communities are present	<b>Low Potential;</b> suitable upland habitats and vegetation communities are present	<b>Low Potential;</b> suitable upland habitats and vegetation communities are present	<b>Low Potential;</b> suitable upland habitats and vegetation communities are present	<b>Low Potential;</b> suitable upland habitats and vegetation communities are present	<b>Low Potential;</b> suitable upland habitats and vegetation communities are present	<b>Low Potential;</b> suitable upland habitats and vegetation communities are present	<b>Low Potential;</b> suitable upland habitats and vegetation communities are present	<b>Low Potential;</b> suitable upland habitats and vegetation communities are present
<i>Plagiobothrys strictus</i> Calistoga popcornflower	FE/ST G1/S1 1B.1	Annual herb. Meadows and seeps, valley and foothill grassland, vernal pools. Alkaline sites near thermal springs and on margins of vernal pools in heavy, dark, adobe-like clay. Elevations: 295-525ft. (90-160m.) Blooms Mar-Jun.	<b>Not Expected;</b> suitable vegetation communities are not present.	<b>Not Expected;</b> suitable vegetation communities are not present.	<b>Not Expected;</b> suitable vegetation communities are not present.	<b>Not Expected;</b> suitable vegetation communities are not present.	<b>Not Expected;</b> suitable vegetation communities are not present.	<b>Not Expected;</b> suitable vegetation communities are not present.	<b>Not Expected;</b> suitable vegetation communities are not present.	<b>Not Expected;</b> suitable vegetation communities are not present.	<b>Not Expected;</b> suitable vegetation communities are not present.	<b>Not Expected;</b> suitable vegetation communities are not present.	<b>Not Expected;</b> suitable vegetation communities are not present.

Sonoma County  
Rezoning Sites for Housing Project

Scientific Name Common Name	Status Fed/ State ESA CRPR	Habitat Requirements	GEY	GUE	LAR	FOR	GRA	SAN	GLE	AGU	PEN	PET	SON
<i>Pleuropogon hooverianus</i> North Coast semaphore grass	None/ST G2/S2 1B.1	Broadleaved upland forest, Meadows and seeps, North Coast coniferous forest. open areas, mesic. 10-671m. perennial rhizomatous herb. Blooms Apr-Jun	<b>Low Potential;</b> suitable vegetation communities are present, suitable soils may be present	<b>Low Potential;</b> suitable vegetation communities are present, suitable soils may be present	<b>Low Potential;</b> suitable vegetation communities are present, suitable soils may be present	<b>Low Potential;</b> suitable vegetation communities are present, suitable soils may be present	<b>Low Potential;</b> suitable vegetation communities are present, suitable soils may be present	<b>Low Potential;</b> suitable vegetation communities are present, suitable soils may be present	<b>Low Potential;</b> suitable vegetation communities are present, suitable soils may be present	<b>Low Potential;</b> suitable vegetation communities are present, suitable soils may be present	<b>Low Potential;</b> suitable vegetation communities are present, suitable soils may be present	<b>Low Potential;</b> suitable vegetation communities are present, suitable soils may be present	<b>Low Potential;</b> suitable vegetation communities are present, suitable soils may be present
<i>Poa napensis</i> Napa blue grass	FE/SE G1/S1 1B.1	Perennial herb. Meadows and seeps, valley and foothill grassland. Moist alkaline meadows fed by runoff from nearby hot springs. Elevations: 330-655ft. (100-200m.) Blooms May- Aug.	<b>Not Expected;</b> suitable vegetation communities are not present.	<b>Not Expected;</b> suitable vegetation communities are not present.	<b>Not Expected;</b> suitable vegetation communities are not present.	<b>Not Expected;</b> suitable vegetation communities are not present.	<b>Not Expected;</b> suitable vegetation communities are not present.	<b>Not Expected;</b> suitable vegetation communities are not present.	<b>Not Expected;</b> suitable vegetation communities are not present.	<b>Not Expected;</b> suitable vegetation communities are not present.	<b>Not Expected;</b> suitable vegetation communities are not present.	<b>Not Expected;</b> suitable vegetation communities are not present.	<b>Not Expected;</b> suitable vegetation communities are not present.
<i>Polemonium carneum</i> Oregon polemonium	None/None G3G4/S2 2B.2	Coastal prairie, Coastal scrub, Lower montane coniferous forest. 0-1830 m. perennial herb. Blooms Apr-Sep	<b>Low Potential;</b> suitable vegetation communities are present, suitable soils may be present	<b>Low Potential;</b> suitable vegetation communities are present, suitable soils may be present	<b>Low Potential;</b> suitable vegetation communities are present, suitable soils may be present	<b>Low Potential;</b> suitable vegetation communities are present, suitable soils may be present	<b>Low Potential;</b> suitable vegetation communities are present, suitable soils may be present	<b>Low Potential;</b> suitable vegetation communities are present, suitable soils may be present	<b>Low Potential;</b> suitable vegetation communities are present, suitable soils may be present	<b>Low Potential;</b> suitable vegetation communities are present, suitable soils may be present	<b>Low Potential;</b> suitable vegetation communities are present, suitable soils may be present	<b>Low Potential;</b> suitable vegetation communities are present, suitable soils may be present	<b>Low Potential;</b> suitable vegetation communities are present, suitable soils may be present
<i>Puccinellia simplex</i> California alkali grass	None/None G3/S2 1B.2	Annual herb. Chenopod scrub, meadows and seeps, valley and foothill grassland, vernal pools. Alkaline, vernally mesic. Sinks, flats, and lake margins. Elevations: 5-3050ft. (2-930m.) Blooms Mar-May.	<b>Not Expected;</b> suitable vegetation communities are not present.	<b>Not Expected;</b> suitable vegetation communities are not present.	<b>Not Expected;</b> suitable vegetation communities are not present.	<b>Not Expected;</b> suitable vegetation communities are not present.	<b>Not Expected;</b> suitable vegetation communities are not present.	<b>Not Expected;</b> suitable vegetation communities are not present.	<b>Not Expected;</b> suitable vegetation communities are not present.	<b>Not Expected;</b> suitable vegetation communities are not present.	<b>Not Expected;</b> suitable vegetation communities are not present.	<b>Not Expected;</b> suitable vegetation communities are not present.	<b>Not Expected;</b> suitable vegetation communities are not present.
<i>Quercus parvula</i> <i>var. tamalpaisensis</i> Tamalpais oak	None/None G4T2/S2 1B.3	Perennial evergreen shrub. Lower montane coniferous forest. Elevations: 330-2460ft. (100-750m.) Blooms Mar-Apr.	<b>Not Expected;</b> suitable vegetation communities are not present.	<b>Low Potential;</b> suitable vegetation communities are present, suitable soils may be present	<b>Not Expected;</b> suitable vegetation communities are not present.	<b>Not Expected;</b> suitable vegetation communities are not present.	<b>Not Expected;</b> suitable vegetation communities are not present.	<b>Not Expected;</b> suitable vegetation communities are not present.	<b>Not Expected;</b> suitable vegetation communities are present, suitable soils may be present	<b>Not Expected;</b> suitable vegetation communities are not present.	<b>Not Expected;</b> suitable vegetation communities are not present.	<b>Not Expected;</b> suitable vegetation communities are not present.	<b>Not Expected;</b> suitable vegetation communities are not present.
<i>Ramalina thrausta</i> angel's hair lichen	None/None G5?/S2S3 2B.1	North Coast coniferous forest. On dead twigs and other lichens. 75-430m. fruticose lichen (epiphytic). Blooms	<b>Not Expected;</b> suitable vegetation communities are not present	<b>Low Potential;</b> suitable vegetation communities are present, suitable soils may be present	<b>Not Expected;</b> suitable vegetation communities are not present	<b>Low Potential;</b> suitable vegetation communities are present, suitable soils may be present	<b>Low Potential;</b> suitable vegetation communities are present, suitable soils may be present	<b>Not Expected;</b> suitable vegetation communities are not present	<b>Not Expected;</b> suitable vegetation communities are not present	<b>Not Expected;</b> suitable vegetation communities are not present	<b>Not Expected;</b> suitable vegetation communities are not present	<b>Not Expected;</b> suitable vegetation communities are not present	<b>Not Expected;</b> suitable vegetation communities are not present
<i>Rhynchospora alba</i> white beaked-rush	None/None G5/S2 2B.3	Bogs and fens, Meadows and seeps, Marshes and swamps (freshwater). 60-2040m. perennial rhizomatous herb. Blooms Jun-Aug	<b>Not Expected;</b> suitable aquatic habitats and vegetation communities are not present	<b>Moderate Potential;</b> freshwater habitats are present.	<b>Moderate Potential;</b> freshwater habitats are present.	<b>Moderate Potential;</b> freshwater habitats are present.	<b>Moderate Potential;</b> freshwater habitats are present.	<b>Moderate Potential;</b> freshwater habitats are present.	<b>Moderate Potential;</b> freshwater habitats are present.	<b>Moderate Potential;</b> freshwater habitats are present.	<b>Moderate Potential;</b> freshwater habitats are present.	<b>Not Expected;</b> suitable aquatic habitats and vegetation communities are not present	<b>Moderate Potential;</b> freshwater aquatic habitats are present.

Scientific Name Common Name	Status Fed/ State ESA CRPR	Habitat Requirements	GEY	GUE	LAR	FOR	GRA	SAN	GLE	AGU	PEN	PET	SON
<i>Rhynchospora californica</i> California beaked-rush	None/None G1/S1 1B.1	Bogs and fens, Lower montane coniferous forest, Meadows andseeps (seeps), Marshes and swamps (freshwater). 45-1010m. perennial rhizomatous herb. Blooms May-Jul	<b>Not Expected;</b> suitable aquatic habitats and vegetation communities are not present	<b>Moderate Potential;</b> freshwater habitats are present.	<b>Moderate Potential;</b> freshwater habitats are present.	<b>Moderate Potential;</b> freshwater habitats are present.	<b>Moderate Potential;</b> freshwater habitats are present.	<b>Moderate Potential;</b> freshwater habitats are present.	<b>Moderate Potential;</b> freshwater habitats are present.	<b>Moderate Potential;</b> freshwater habitats are present.	<b>Moderate Potential;</b> freshwater habitats are present.	<b>Not Expected;</b> suitable aquatic habitats and vegetation communities are not present	<b>Moderate Potential;</b> freshwater aquatic habitatsare present.
<i>Rhynchospora capitellata</i> brownish beaked-rush	None/None G5/S1 2B.2	Lower montane coniferous forest, Meadows and seeps, Marshes and swamps, Upper montane coniferous forest. mesic. 45 - 2000 m. perennial herb. Blooms Jul-Aug	<b>Not Expected;</b> suitable aquatic habitats and vegetation communities are not present	<b>Moderate Potential;</b> freshwater habitats are present.	<b>Moderate Potential;</b> freshwater habitats are present.	<b>Moderate Potential;</b> freshwater habitats are present.	<b>Moderate Potential;</b> freshwater habitats are present.	<b>Moderate Potential;</b> freshwater habitats are present.	<b>Moderate Potential;</b> freshwater habitats are present.	<b>Moderate Potential;</b> freshwater habitats are present.	<b>Moderate Potential;</b> freshwater habitats are present.	<b>Not Expected;</b> suitable aquatic habitats and vegetation communities are not present	<b>Moderate Potential;</b> freshwater aquatic habitatsare present.
<i>Rhynchosporaglobularis</i> round-headedbeaked-rush	None/None G5/S1 2B.1	Marshes and swamps (freshwater). 45-60 m. perennial rhizomatous herb. Blooms Jul-Aug	<b>Not Expected;</b> suitable aquatic habitats and vegetation communities are not present	<b>Moderate Potential;</b> freshwater habitats are present.	<b>Moderate Potential;</b> freshwater habitats are present.	<b>Moderate Potential;</b> freshwater habitats are present.	<b>Moderate Potential;</b> freshwater habitats are present.	<b>Moderate Potential;</b> freshwater habitats are present.	<b>Moderate Potential;</b> freshwater habitats are present.	<b>Moderate Potential;</b> freshwater habitats are present.	<b>Moderate Potential;</b> freshwater habitats are present.	<b>Not Expected;</b> suitable aquatic habitats and vegetation communities are not present	<b>Moderate Potential;</b> freshwater aquatic habitatsare present.
<i>Sagittaria sanfordii</i> Sanford's arrowhead	None/None G3/S3 1B.2	Perennial rhizomatous herb (emergent). Marshes and swamps. In standing or slow-moving freshwater ponds, marshes, and ditches. Elevations: 0-2135ft. (0-650m.) Blooms May-Oct(Nov).	<b>Not Expected;</b> suitable vegetation communities are not present.	<b>Not Expected;</b> suitable vegetation communities are not present.	<b>Not Expected;</b> suitable vegetation communities are not present.	<b>Not Expected;</b> suitable vegetation communities are not present.	<b>Not Expected;</b> suitable vegetation communities are not present.	<b>Not Expected;</b> suitable vegetation communities are not present.	<b>Not Expected;</b> suitable vegetation communities are not present.	<b>Not Expected;</b> suitable vegetation communities are not present.	<b>Not Expected;</b> suitable vegetation communities are not present.	<b>Not Expected;</b> suitable vegetation communities are not present.	<b>Not Expected;</b> suitable vegetation communities are not present.
<i>Sidalcea calycosassp. rhizomata</i> Point Reyes checkerbloom	None/None G5T2/S2 1B.2	Marshes and swamps (freshwater, near coast). 3-75m. perennial rhizomatous herb. Blooms Apr-Sep	<b>Not Expected;</b> suitable aquatic habitats and vegetation communities are not present	<b>Moderate Potential;</b> freshwater habitats are present.	<b>Moderate Potential;</b> freshwater habitats are present.	<b>Moderate Potential;</b> freshwater habitats are present.	<b>Moderate Potential;</b> freshwater habitats are present.	<b>Moderate Potential;</b> freshwater habitats are present.	<b>Moderate Potential;</b> freshwater habitats are present.	<b>Moderate Potential;</b> freshwater habitats are present.	<b>Moderate Potential;</b> freshwater habitats are present.	<b>Not Expected;</b> suitable aquatic habitats and vegetation communities are not present	<b>Moderate Potential;</b> freshwater aquatic habitatsare present.
<i>Sidalcea hickmanii ssp. napensis</i> Napa checkerbloom	None/None G3T1/S1 1B.1	Chaparral. rhyolitic. 415-610m. perennial herb. Blooms Apr-Jun	<b>Not Expected;</b> suitable soils and vegetation communities are not present.	<b>Not Expected;</b> suitable soils and vegetation communities are not present.	<b>Not Expected;</b> suitable soils and vegetation communities are not present.	<b>Not Expected;</b> suitable soils and vegetation communities are not present.	<b>Not Expected;</b> suitable soils and vegetation communities are not present.	<b>Not Expected;</b> suitable soils and vegetation communities are not present.	<b>Not Expected;</b> suitable soils and vegetation communities are not present.	<b>Not Expected;</b> suitable soils and vegetation communities are not present.	<b>Not Expected;</b> suitable soils and vegetation communities are not present.	<b>Not Expected;</b> suitable soils and vegetation communities are not present.	<b>Not Expected;</b> suitable soils and vegetation communities are not present.
<i>Sidalcea hickmanii ssp. viridis</i> Marin checkerbloom	None/None G3TH/SH 1B.1	Chaparral (serpentinite). 50-430 m. perennial herb. Blooms May-Jun	<b>Not Expected;</b> suitable vegetation communities are not present.	<b>Not Expected;</b> suitable vegetation communities are not present.	<b>Not Expected;</b> suitable vegetation communities are not present.	<b>Not Expected;</b> suitable vegetation communities are not present.	<b>Not Expected;</b> suitable vegetation communities are not present.	<b>Not Expected;</b> suitable vegetation communities are not present.	<b>Not Expected;</b> suitable vegetation communities are not present.	<b>Not Expected;</b> suitable vegetation communities are not present.	<b>Not Expected;</b> suitable vegetation communities are not present.	<b>Not Expected;</b> suitable vegetation communities are not present.	<b>Not Expected;</b> suitable vegetation communities are not present.
<i>Sidalcea malviflorassp. purpurea</i> purple-stemmed checkerbloom	None/None G5T1/S1 1B.2	Broadleafed upland forest, Coastal prairie. 15-85m. perennial rhizomatous herb. Blooms May-Jun	<b>Low Potential;</b> suitable vegetation communities are present, suitable soils may be present	<b>Low Potential;</b> suitable vegetation communities are present, suitable soils may be present	<b>Low Potential;</b> suitable vegetation communities are present, suitable soils may be present	<b>Low Potential;</b> suitable vegetation communities are present, suitable soils may be present	<b>Low Potential;</b> suitable vegetation communities are present, suitable soils may be present	<b>Low Potential;</b> suitable vegetation communities are present, suitable soils may be present	<b>Low Potential;</b> suitable vegetation communities are present, suitable soils may be present	<b>Low Potential;</b> suitable vegetation communities are present, suitable soils may be present	<b>Low Potential;</b> suitable vegetation communities are present, suitable soils may be present	<b>Low Potential;</b> suitable vegetation communities are present, suitable soils may be present	<b>Low Potential;</b> suitable vegetation communities are present, suitable soils may be present

Sonoma County  
**Rezone Sites for Housing Project**

Scientific Name Common Name	Status Fed/ State ESA CRPR	Habitat Requirements	GEY	GUE	LAR	FOR	GRA	SAN	GLE	AGU	PEN	PET	SON
<i>Sidalcea oregana ssp. hydrophila</i> marsh checkerbloom	None/None G5T2/S2 1B.2	Perennial herb. Meadows and seeps, riparian forest. Wet soil of streambanks, meadows. Elevations: 3610-7545ft. (1100-2300m.) Blooms (Jun)Jul-Aug.	<b>Not Expected;</b> suitable soils and vegetation communities are not present.	<b>Not Expected;</b> suitable soils and vegetation communities are not present.	<b>Not Expected;</b> suitable soils and vegetation communities are not present.	<b>Not Expected;</b> suitable soils and vegetation communities are not present.	<b>Not Expected;</b> suitable soils and vegetation communities are not present.	<b>Not Expected;</b> suitable soils and vegetation communities are not present.	<b>Not Expected;</b> suitable soils and vegetation communities are not present.	<b>Not Expected;</b> suitable soils and vegetation communities are not present.	<b>Not Expected;</b> suitable soils and vegetation communities are not present.	<b>Not Expected;</b> suitable soils and vegetation communities are not present.	<b>Not Expected;</b> suitable soils and vegetation communities are not present.
<i>Sidalcea oregana ssp. valida</i> Kenwood Marsh checkerbloom	FE/SE G5T1/S1 1B.1	Marshes and swamps (freshwater). 115-150m. perennial rhizomatous herb. Blooms Jun-Sep	<b>Not Expected;</b> suitable aquatic habitats and vegetation communities are not present	<b>Moderate Potential;</b> freshwater habitats are present.	<b>Moderate Potential;</b> freshwater habitats are present.	<b>Moderate Potential;</b> freshwater habitats are present.	<b>Moderate Potential;</b> freshwater habitats are present.	<b>Moderate Potential;</b> freshwater habitats are present.	<b>Moderate Potential;</b> freshwater habitats are present.	<b>Moderate Potential;</b> freshwater habitats are present.	<b>Moderate Potential;</b> freshwater habitats are present.	<b>Not Expected;</b> suitable aquatic habitats and vegetation communities are not present	<b>Moderate Potential;</b> freshwater aquatic habitatsare present.
<i>Silene scouleri ssp. scouleri</i> Scouler's catchfly	None/None G5T4T5/S2S3 2B.2	Coastal bluff scrub, Coastal prairie, Valley and foothill grassland. 0-600m. perennial herb. Blooms (Mar-May)Jun-Aug(Sep)	<b>Not Expected;</b> suitable vegetation communities are not present.	<b>Not Expected;</b> suitable vegetation communities are not present.	<b>Not Expected;</b> suitable vegetation communities are not present.	<b>Not Expected;</b> suitable vegetation communities are not present.	<b>Not Expected;</b> suitable vegetation communities are not present.	<b>Not Expected;</b> suitable vegetation communities are not present.	<b>Not Expected;</b> suitable vegetation communities are not present.	<b>Not Expected;</b> suitable vegetation communities are not present.	<b>Not Expected;</b> suitable vegetation communities are not present.	<b>Not Expected;</b> suitable vegetation communities are not present.	<b>Not Expected;</b> suitable vegetation communities are not present.
<i>Spergularia macrotheca var. longistyla</i> long-styled sand-spurrey	None/None G5T2/S2 1B.2	Perennial herb. Marshes and swamps, meadows and seeps. Alkaline. Elevations: 0-835ft. (0-255m.) Blooms Feb-May.	<b>Not Expected;</b> suitable vegetation communities are not present.	<b>Not Expected;</b> suitable vegetation communities are not present.	<b>Not Expected;</b> suitable vegetation communities are not present.	<b>Not Expected;</b> suitable vegetation communities are not present.	<b>Not Expected;</b> suitable vegetation communities are not present.	<b>Not Expected;</b> suitable vegetation communities are not present.	<b>Not Expected;</b> suitable vegetation communities are not present.	<b>Not Expected;</b> suitable vegetation communities are not present.	<b>Not Expected;</b> suitable vegetation communities are not present.	<b>Not Expected;</b> suitable vegetation communities are not present.	<b>Not Expected;</b> suitable vegetation communities are not present.
<i>Streptanthus anomalus</i> Mount Burdell jewelflower	None/None G1/S1 1B.1	Annual herb. Cismontane woodland. Openings, Serpentinite. Elevations: 165-490ft. (50-150m.) Blooms May-Jun.	<b>Low Potential;</b> suitable vegetation communities are present, suitable soils may be present	<b>Low Potential;</b> suitable vegetation communities are present, suitable soils may be present	<b>Low Potential;</b> suitable vegetation communities are present, suitable soils may be present	<b>Low Potential;</b> suitable vegetation communities are present, suitable soils may be present	<b>Low Potential;</b> suitable vegetation communities are present, suitable soils may be present	<b>Low Potential;</b> suitable vegetation communities are present, suitable soils may be present	<b>Low Potential;</b> suitable vegetation communities are present, suitable soils may be present	<b>Low Potential;</b> suitable vegetation communities are present, suitable soils may be present	<b>Low Potential;</b> suitable vegetation communities are present, suitable soils may be present	<b>Low Potential;</b> suitable vegetation communities are present, suitable soils may be present	<b>Low Potential;</b> suitable vegetation communities are present, suitable soils may be present
<i>Streptanthus batrachopus</i> Tamalpais jewelflower	None/None G2/S2 1B.3	Annual herb. Chaparral, closed-cone coniferous forest. Talus serpentine outcrops. Elevations: 1000-2135ft. (305-650m.) Blooms Apr-Jul.	<b>Not Expected;</b> suitable soils and vegetation communities are not present.	<b>Not Expected;</b> suitable soils and vegetation communities are not present.	<b>Not Expected;</b> suitable soils and vegetation communities are not present.	<b>Not Expected;</b> suitable soils and vegetation communities are not present.	<b>Not Expected;</b> suitable soils and vegetation communities are not present.	<b>Not Expected;</b> suitable soils and vegetation communities are not present.	<b>Not Expected;</b> suitable soils and vegetation communities are not present.	<b>Not Expected;</b> suitable soils and vegetation communities are not present.	<b>Not Expected;</b> suitable soils and vegetation communities are not present.	<b>Not Expected;</b> suitable soils and vegetation communities are not present.	<b>Not Expected;</b> suitable soils and vegetation communities are not present.
<i>Streptanthus brachiatus ssp. brachiatus</i> Socrates Mine jewelflower	None/None G2T1/S1 1B.2	Closed-cone coniferous forest, Chaparral. usually serpentinite.545-1000m. perennial herb. Blooms May-Jun	<b>Not Expected;</b> suitable vegetation communities are not present.	<b>Not Expected;</b> suitable vegetation communities are not present.	<b>Not Expected;</b> suitable vegetation communities are not present.	<b>Not Expected;</b> suitable vegetation communities are not present.	<b>Not Expected;</b> suitable vegetation communities are not present.	<b>Not Expected;</b> suitable vegetation communities are not present.	<b>Not Expected;</b> suitable vegetation communities are not present.	<b>Not Expected;</b> suitable vegetation communities are not present.	<b>Not Expected;</b> suitable vegetation communities are not present.	<b>Not Expected;</b> suitable vegetation communities are not present.	<b>Not Expected;</b> suitable vegetation communities are not present.
<i>Streptanthus brachiatus ssp. hoffmanii</i> Freed's jewelflower	None/None G2T2/S2 1B.2	Chaparral, Cismontane woodland. serpentinite. 490-1220m. perennial herb. BloomsMay-Jul	<b>Not Expected;</b> suitable vegetation communities are not present.	<b>Not Expected;</b> suitable vegetation communities are not present.	<b>Not Expected;</b> suitable vegetation communities are not present.	<b>Not Expected;</b> suitable vegetation communities are not present.	<b>Not Expected;</b> suitable vegetation communities are not present.	<b>Not Expected;</b> suitable vegetation communities are not present.	<b>Not Expected;</b> suitable vegetation communities are not present.	<b>Not Expected;</b> suitable vegetation communities are not present.	<b>Not Expected;</b> suitable vegetation communities are not present.	<b>Not Expected;</b> suitable vegetation communities are not present.	<b>Not Expected;</b> suitable vegetation communities are not present.
<i>Streptanthus glandulosus ssp. hoffmanii</i> Hoffman's bristlyjewelflower	None/None G4T2/S2 1B.3	Chaparral, Cismontane woodland, Valley and foothill grassland (often serpentinite). rocky. 120-475m. annual herb. Blooms Mar-Jul	<b>Low Potential;</b> suitable vegetation communities are present, suitable soils may be present	<b>Low Potential;</b> suitable vegetation communities are present, suitable soils may be present	<b>Low Potential;</b> suitable vegetation communities are present, suitable soils may be present	<b>Low Potential;</b> suitable vegetation communities are present, suitable soils may be present	<b>Low Potential;</b> suitable vegetation communities are present, suitable soils may be present	<b>Low Potential;</b> suitable vegetation communities are present, suitable soils may be present	<b>Low Potential;</b> suitable vegetation communities are present, suitable soils may be present	<b>Low Potential;</b> suitable vegetation communities are present, suitable soils may be present	<b>Low Potential;</b> suitable vegetation communities are present, suitable soils may be present	<b>Low Potential;</b> suitable vegetation communities are present, suitable soils may be present	<b>Low Potential;</b> suitable vegetation communities are present, suitable soils may be present

Scientific Name Common Name	Status Fed/ State ESA CRPR	Habitat Requirements	GEY	GUE	LAR	FOR	GRA	SAN	GLE	AGU	PEN	PET	SON
<i>Streptanthus glandulosus</i> <i>ssp. pulchellus</i> Mt. Tamalpais bristly jewelflower	None/None G4T2/S2 1B.2	Annual herb. Chaparral, valley and foothill grassland. Serpentine slopes. Elevations: 490-2625ft. (150-800m.) Blooms May- Jul(Aug).	<b>Not Expected;</b> suitable soils and vegetation communities are not present.	<b>Not Expected;</b> suitable soils and vegetation communities are not present.	<b>Not Expected;</b> suitable soils and vegetation communities are not present.	<b>Not Expected;</b> suitable soils and vegetation communities are not present.	<b>Not Expected;</b> suitable soils and vegetation communities are not present.	<b>Not Expected;</b> suitable soils and vegetation communities are not present.	<b>Not Expected;</b> suitable soils and vegetation communities are not present.	<b>Not Expected;</b> suitable soils and vegetation communities are not present.	<b>Not Expected;</b> suitable soils and vegetation communities are not present.	<b>Not Expected;</b> suitable soils and vegetation communities are not present.	<b>Not Expected;</b> suitable soils and vegetation communities are not present.
<i>Streptanthushesperidis</i> green jewelflower	None/None G2G3/S2S3 1B.2	Chaparral (openings), Cismontane woodland. serpentinite, rocky. 130-760m.annual herb. Blooms May-Jul	<b>Low Potential;</b> suitable vegetation communities are present, suitable soils may be present	<b>Low Potential;</b> suitable vegetation communities are present, suitable soils may be present	<b>Low Potential;</b> suitable vegetation communities are present, suitable soils may be present	<b>Low Potential;</b> suitable vegetation communities are present, suitable soils may be present	<b>Low Potential;</b> suitable vegetation communities are present, suitable soils may be present	<b>Low Potential;</b> suitable vegetation communities are present, suitable soils may be present	<b>Low Potential;</b> suitable vegetation communities are present, suitable soils may be present	<b>Low Potential;</b> suitable vegetation communities are present, suitable soils may be present	<b>Low Potential;</b> suitable vegetation communities are present, suitable soils may be present	<b>Low Potential;</b> suitable vegetation communities are present, suitable soils may be present	<b>Low Potential;</b> suitable vegetation communities are present, suitable soils may be present
<i>Streptanthus morrisonii</i> <i>ssp.</i> <i>hirtiflorus</i> Dorr's Cabin jewelflower	None/None G2T1/S1 1B.2	Closed-cone coniferous forest,Chaparral. serpentinite. 185 - 820 m. perennial herb. BloomsJun	<b>Not Expected;</b> suitable vegetation communities are not present.	<b>Not Expected;</b> suitable vegetation communities are not present.	<b>Not Expected;</b> suitable vegetation communities are not present.	<b>Not Expected;</b> suitable vegetation communities are not present.	<b>Not Expected;</b> suitable vegetation communities are not present.	<b>Not Expected;</b> suitable vegetation communities are not present.	<b>Not Expected;</b> suitable vegetation communities are not present.	<b>Not Expected;</b> suitable vegetation communities are not present.	<b>Not Expected;</b> suitable vegetation communities are not present.	<b>Not Expected;</b> suitable vegetation communities are not present.	<b>Not Expected;</b> suitable vegetation communities are not present.
<i>Streptanthus morrisonii</i> <i>ssp.</i> <i>morrisonii</i> Morrison's jewelflower	None/None G2T1?/S1? 1B.2	Chaparral (serpentinite, rocky,talus). 120 - 585 m. perennial herb. Blooms May, Aug, Sep	<b>Not Expected;</b> suitable vegetation communities are not present.	<b>Not Expected;</b> suitable vegetation communities are not present.	<b>Not Expected;</b> suitable vegetation communities are not present.	<b>Not Expected;</b> suitable vegetation communities are not present.	<b>Not Expected;</b> suitable vegetation communities are not present.	<b>Not Expected;</b> suitable vegetation communities are not present.	<b>Not Expected;</b> suitable vegetation communities are not present.	<b>Not Expected;</b> suitable vegetation communities are not present.	<b>Not Expected;</b> suitable vegetation communities are not present.	<b>Not Expected;</b> suitable vegetation communities are not present.	<b>Not Expected;</b> suitable vegetation communities are not present.
<i>Stuckenia filiformis</i> <i>ssp. alpina</i> northern slender pondweed	None/None G5T5/S2S3 2B.2	Marshes and swamps (assortedshallow freshwater). 300 - 2150m. perennial rhizomatous herb (aquatic). Blooms May-Jul	<b>Not Expected;</b> suitable aquatic habitats and vegetation communities are not present	<b>Moderate Potential;</b> freshwater habitats are present.	<b>Moderate Potential;</b> freshwater habitats are present.	<b>Moderate Potential;</b> freshwater habitats are present.	<b>Moderate Potential;</b> freshwater habitats are present.	<b>Moderate Potential;</b> freshwater habitats are present.	<b>Moderate Potential;</b> freshwater habitats are present.	<b>Moderate Potential;</b> freshwater habitats are present.	<b>Moderate Potential;</b> freshwater habitats are present.	<b>Not Expected;</b> suitable aquatic habitats and vegetation communities are not present	<b>Moderate Potential;</b> freshwater aquatic habitatsare present.
<i>Symphyotrichum lentum</i> Suisun Marsh aster	None/None G2/S2 1B.2	Perennial rhizomatous herb. Marshes and swamps. Most often seen along sloughs with Phragmites, Scirpus, blackberry, Typha, etc. Elevations: 0-10ft. (0-3m.) Blooms (Apr)May-Nov.	<b>Not Expected;</b> suitable soils and vegetation communities are not present.	<b>Not Expected;</b> suitable soils and vegetation communities are not present.	<b>Not Expected;</b> suitable soils and vegetation communities are not present.	<b>Not Expected;</b> suitable soils and vegetation communities are not present.	<b>Not Expected;</b> suitable soils and vegetation communities are not present.	<b>Not Expected;</b> suitable soils and vegetation communities are not present.	<b>Not Expected;</b> suitable soils and vegetation communities are not present.	<b>Not Expected;</b> suitable soils and vegetation communities are not present.	<b>Not Expected;</b> suitable soils and vegetation communities are not present.	<b>Not Expected;</b> suitable soils and vegetation communities are not present.	<b>Not Expected;</b> suitable soils and vegetation communities are not present.
<i>Thamnotia vermicularis</i> whiteworm lichen	None/None G5/S1 2B.1	Fruticose lichen (terricolous). Chaparral, valley and foothill grassland. On rocks derived from Wilson Ranch formation sandstone. Elevations: 295- 295ft. (90-90m.)	<b>Not Expected;</b> suitable soils and vegetation communities are not present.	<b>Not Expected;</b> suitable soils and vegetation communities are not present.	<b>Not Expected;</b> suitable soils and vegetation communities are not present.	<b>Not Expected;</b> suitable soils and vegetation communities are not present.	<b>Not Expected;</b> suitable soils and vegetation communities are not present.	<b>Not Expected;</b> suitable soils and vegetation communities are not present.	<b>Not Expected;</b> suitable soils and vegetation communities are not present.	<b>Not Expected;</b> suitable soils and vegetation communities are not present.	<b>Not Expected;</b> suitable soils and vegetation communities are not present.	<b>Not Expected;</b> suitable soils and vegetation communities are not present.	<b>Not Expected;</b> suitable soils and vegetation communities are not present.
<i>Trichostema ruygtii</i> Napa bluecurls	None/None G1G2/S1S2 1B.2	Annual herb. Chaparral, cismontane woodland, lower montane coniferous forest, valley and foothill grassland, vernal pools. Often in open, sunny areas. Also has been found in vernal pools. Elevations: 100-2230ft. (30- 680m.) Blooms Jun-Oct.	<b>Low Potential;</b> suitable vegetation communities are present, suitable soils may be present	<b>Low Potential;</b> suitable vegetation communities are present, suitable soils may be present	<b>Low Potential;</b> suitable vegetation communities are present, suitable soils may be present	<b>Low Potential;</b> suitable vegetation communities are present, suitable soils may be present	<b>Low Potential;</b> suitable vegetation communities are present, suitable soils may be present	<b>Low Potential;</b> suitable vegetation communities are present, suitable soils may be present	<b>Low Potential;</b> suitable vegetation communities are present, suitable soils may be present	<b>Low Potential;</b> suitable vegetation communities are present, suitable soils may be present	<b>Low Potential;</b> suitable vegetation communities are present, suitable soils may be present	<b>Low Potential;</b> suitable vegetation communities are present, suitable soils may be present	<b>Low Potential;</b> suitable vegetation communities are present, suitable soils may be present

Sonoma County  
**Rezone Sites for Housing Project**

Scientific Name Common Name	Status Fed/ State ESA CRPR	Habitat Requirements	GEY	GUE	LAR	FOR	GRA	SAN	GLE	AGU	PEN	PET	SON
<i>Trifolium amoenum</i> two-fork clover	FE/None G1/S1 1B.1	Coastal bluff scrub, Valley and foothill grassland (sometimes serpentinite). 5-415 m. annualherb. Blooms Apr-Jun	<b>Low Potential;</b> suitable vegetation communities are present, suitable soils may be present	<b>Low Potential;</b> suitable vegetation communities are present, suitable soils may be present	<b>Low Potential;</b> suitable vegetation communities are present, suitable soils may be present	<b>Low Potential;</b> suitable vegetation communities are present, suitable soils may be present	<b>Low Potential;</b> suitable vegetation communities are present, suitable soils may be present	<b>Low Potential;</b> suitable vegetation communities are present, suitable soils may be present	<b>Low Potential;</b> suitable vegetation communities are present, suitable soils may be present	<b>Low Potential;</b> suitable vegetation communities are present, suitable soils may be present	<b>Low Potential;</b> suitable vegetation communities are present, suitable soils may be present	<b>Low Potential;</b> suitable vegetation communities are present, suitable soils may be present	<b>Low Potential;</b> suitable vegetation communities are present, suitable soils may be present
<i>Trifolium buckwestiorum</i> Santa Cruz clover	None/None G2/S2 1B.1	Broadleafed upland forest, Cismontane woodland, Coastalprairie. gravelly, margins. 105 -610 m. annual herb. Blooms Apr-Oct	<b>Low Potential;</b> suitable vegetation communities are present, suitable soils may be present	<b>Low Potential;</b> suitable vegetation communities are present, suitable soils may be present	<b>Low Potential;</b> suitable vegetation communities are present, suitable soils may be present	<b>Low Potential;</b> suitable vegetation communities are present, suitable soils may be present	<b>Low Potential;</b> suitable vegetation communities are present, suitable soils may be present	<b>Low Potential;</b> suitable vegetation communities are present, suitable soils may be present	<b>Low Potential;</b> suitable vegetation communities are present, suitable soils may be present	<b>Low Potential;</b> suitable vegetation communities are present, suitable soils may be present	<b>Low Potential;</b> suitable vegetation communities are present, suitable soils may be present	<b>Low Potential;</b> suitable vegetation communities are present, suitable soils may be present	<b>Low Potential;</b> suitable vegetation communities are present, suitable soils may be present
<i>Trifolium hydrophilum</i> saline clover	None/None G2/S2 1B.2	Marshes and swamps, Valley and foothill grassland (mesic, alkaline), Vernal pools. 0 - 300 m. annual herb. Blooms Apr-Jun	<b>Not Expected;</b> suitable aquatic habitats and vegetation communities are not present	<b>Moderate Potential;</b> freshwater habitats are present.	<b>Moderate Potential;</b> freshwater habitats are present.	<b>Moderate Potential;</b> freshwater habitats are present.	<b>Moderate Potential;</b> freshwater habitats are present.	<b>Moderate Potential;</b> freshwater habitats are present.	<b>Moderate Potential;</b> freshwater habitats are present.	<b>Moderate Potential;</b> freshwater habitats are present.	<b>Moderate Potential;</b> freshwater habitats are present.	<b>Not Expected;</b> suitable aquatic habitats and vegetation communities are not present	<b>Moderate Potential;</b> freshwater aquatic habitatsare present.
<i>Trifolium polyodont</i> Pacific Grove clover	None/SR G1/S1 1B.1	Closed-cone coniferous forest, Coastal prairie, Meadows and seeps, Valley and foothill grassland. mesic, sometimes granitic. 5 - 425 m. annual herb. Blooms Apr-Jun(Jul)	<b>Not Expected;</b> suitable aquatic habitats and vegetation communities are not present	<b>Moderate Potential;</b> freshwater habitats are present.	<b>Moderate Potential;</b> freshwater habitats are present.	<b>Moderate Potential;</b> freshwater habitats are present.	<b>Moderate Potential;</b> freshwater habitats are present.	<b>Moderate Potential;</b> freshwater habitats are present.	<b>Moderate Potential;</b> freshwater habitats are present.	<b>Moderate Potential;</b> freshwater habitats are present.	<b>Moderate Potential;</b> freshwater habitats are present.	<b>Not Expected;</b> suitable aquatic habitats and vegetation communities are not present	<b>Moderate Potential;</b> freshwater aquatic habitatsare present.
<i>Triphysaria floribunda</i> San Francisco owl's-clover	None/None G2?/S2? 1B.2	Annual herb. Coastal prairie, coastal scrub, valley and foothill grassland. On serpentine and non-serpentine substrate (such as at Pt. Reyes). Elevations: 35-525ft. (10-160m.) Blooms Apr-Jun.	<b>Not Expected;</b> suitable vegetation communities are not present.	<b>Not Expected;</b> suitable vegetation communities are not present.	<b>Not Expected;</b> suitable vegetation communities are not present.	<b>Not Expected;</b> suitable vegetation communities are not present.	<b>Not Expected;</b> suitable vegetation communities are not present.	<b>Not Expected;</b> suitable vegetation communities are not present.	<b>Not Expected;</b> suitable vegetation communities are not present.	<b>Not Expected;</b> suitable vegetation communities are not present.	<b>Not Expected;</b> suitable vegetation communities are not present.	<b>Not Expected;</b> suitable vegetation communities are not present.	<b>Not Expected;</b> suitable vegetation communities are not present.
<i>Triquetrellacalifornica</i> coastal triquetrella	None/None G2/S2 1B.2	Coastal bluff scrub, Coastal scrub. soil. 10 - 100 m. moss.	<b>Not Expected;</b> suitable vegetation communities are not present.	<b>Not Expected;</b> suitable vegetation communities are not present.	<b>Not Expected;</b> suitable vegetation communities are not present.	<b>Not Expected;</b> suitable vegetation communities are not present.	<b>Not Expected;</b> suitable vegetation communities are not present.	<b>Not Expected;</b> suitable vegetation communities are not present.	<b>Not Expected;</b> suitable vegetation communities are not present.	<b>Not Expected;</b> suitable vegetation communities are not present.	<b>Not Expected;</b> suitable vegetation communities are not present.	<b>Not Expected;</b> suitable vegetation communities are not present.	<b>Not Expected;</b> suitable vegetation communities are not present.

Scientific Name Common Name	Status Fed/ State ESA CRPR	Habitat Requirements	GEY	GUE	LAR	FOR	GRA	SAN	GLE	AGU	PEN	PET	SON
<i>Viburnum ellipticum</i> oval-leaved viburnum	None/None G4G5/S3? 2B.3	Chaparral, Cismontane woodland, Lower montane coniferous forest. 215 - 1400 m. perennial deciduous shrub. Blooms May-Jun	<b>Not Expected;</b> suitable vegetation communities are not present.	<b>Not Expected;</b> suitable vegetation communities are not present.	<b>Not Expected;</b> suitable vegetation communities are not present.	<b>Not Expected;</b> Suitable vegetation communities are not present.	<b>Not Expected;</b> suitable vegetation communities are not present.	<b>Not Expected;</b> suitable vegetation communities are not present.	<b>Not Expected;</b> suitable vegetation communities are not present.	<b>Not Expected;</b> suitable vegetation communities are not present.	<b>Not Expected;</b> suitable vegetation communities are not present.	<b>Not Expected;</b> suitable vegetation communities are not present.	<b>Not Expected;</b> suitable vegetation communities are not present.

FE = Federally Endangered      FT = Federally Threatened  
 SE = State Endangered      ST = State Threatened      SR = State Rare      SCE = State Candidate Endangered  
 G-Rank/S-Rank = Global Rank and State Rank as per NatureServe and CDFW's CNDDDB RareFind3.  
 CRPR (CNPS California Rare Plant Rank):  
 1A=Presumed Extinct in California  
 1B=Rare, Threatened, or Endangered in California and elsewhere 2A=Plants presumed extirpated in California, but more common elsewhere  
 2B=Plants Rare, Threatened, or Endangered in California, but more common elsewhere3=Need more information (a Review List)  
 4=Plants of Limited Distribution (a Watch List)CRPR Threat Code Extension:  
 .1=Seriously endangered in California (over 80% of occurrences threatened / high degree and immediacy of threat)  
 .2=Fairly endangered in California (20-80% occurrences threatened)  
 .3=Not very endangered in California (<20% of occurrences threatened)

**USGS 7.5-minute quadrangles Reviewed:**  
 Geyserville (3812268), Cazadero (3812351), Healdsburg (3812257), Guerneville (3812258), Camp Meeker (3812248), Sebastopol (3812247), Santa Rosa (3812246), Cotati (3812236), Glen Ellen (3812235), Petaluma (3812226), Sonoma (3812234), Cloverdale (3812371), Asti (3812278), The Geysers (3812277), Jimtown (3812267), Warm Springs Dam (3812361), Tombs Creek (3812362), Arched Rock (3812342), Duncans Mills (3812341), Bodega Head (3812331), Valley Ford (3812238), Two Rock (3812237), Point Reyes NE (3812227), Inverness (3812217), San Geronimo (3812216), Novato (3812215), Petaluma River (3812225), Sears Point (3812224), Cuttings Wharf (3812223), Napa (3812233), Yountville (3812243), Rutherford (3812244), Kenwood (3812245), Calistoga (3812255), Mark West Springs (3812256), Mount St. Helena (3812266), Fort Ross (3812352)

Special Status Animal Species in the Regional Vicinity of the Project Site

Scientific Name Common Name	Status Fed/ State ESA CDFW	Habitat Requirements	GEY	GUE	LAR	FOR	GRA	SAN	GLE	AGU	PEN	PET	SON
<b>Invertebrates</b>													
<i>Bombus crotchii</i> Crotch bumble bee	None/SC G3G4/S1S2	Coastal California east to the Sierra-Cascade crest and south into Mexico. Food plant genera include <i>Antirrhinum</i> , <i>Phacelia</i> , <i>Clarkia</i> , <i>Dendromecon</i> , <i>Eschscholzia</i> , and <i>Eriogonum</i> .	Low potential; suitable habitat may be present.	Low potential; suitable habitat may be present.	Low potential; suitable habitat may be present.	Low potential; suitable habitat may be present.	Low potential; suitable habitat may be present.	Low potential; suitable habitat may be present.	Low Potential;1 historical CNDDDB occurrence approximately 2 miles north of site (1910), suitable habitat may be present.	Low Potential;1 historical CNDDDB occurrence approximately 2.2 miles northwest of site (1910), suitable habitat may be present.	Low potential; suitable habitat may be present.	Low potential; suitable habitat may be present.	Low Potential;1 historical CNDDDB occurrence approximately 4.6 miles northwest of site (1910), suitable habitat may be present.
<i>Bombus occidentalis</i> western bumblebee	None/SC G2G3/S1	Once common & widespread, species has declined precipitously from central CA to southern B.C., perhaps from disease.	Low potential; suitable habitat may be present.	Low potential; suitable habitat may be present.	Low potential; suitable habitat may be present.	Low potential; suitable habitat may be present.	Low potential;1 historical CNDDDB occurrence approximately 4.8 miles southwest of site, suitable habitat may be present.	Low potential;1 historical CNDDDB occurrence approximately 0.25 miles southwest of site (1986), suitable habitat may be present.	Low potential;2 historical CNDDDB occurrences approximately 2 miles north of site (1960, 1962) suitable habitat may be present.	Low potential;2 historical CNDDDB occurrences (1958, 1960), including 1 occurrence approximately 1.6 miles southeast of site suitable habitat may be present.	Low potential;1 historical CNDDDB occurrence approximately 4 miles south of site (1965) suitable habitat may be present.	Low potential;2 historical CNDDDB occurrences within 5 miles of site including one occurrence approximately 0.2 miles east of site but occurrence is historical (1965) suitable habitat may be present.	Low potential;2 historical CNDDDB occurrences within 5 miles of site including one occurrence is historical (1958) suitable habitat may be present.
<i>Danaus plexippus</i> <i>pop. 1</i> monarch - California overwintering population	FC/None G4T1T2/S2	Winter roost sites extend along the coast from northern Mendocino to Baja California, Mexico. Roosts located in wind-protected tree groves (eucalyptus, Monterey pine, cypress), with nectar and water sources nearby.	Not Expected; no suitable coastal/frost protected habitat present.	Not Expected; no suitable coastal/frost protected habitat present.	Not Expected; no suitable coastal/frost protected habitat present.	Not Expected; no suitable coastal/frost protected habitat present.	Not Expected; no suitable coastal/frost protected habitat present.	Not Expected; no suitable coastal/frost protected habitat present.	Not Expected; no suitable coastal/frost protected habitat present.	Not Expected; no suitable coastal/frost protected habitat present.	Not Expected; no suitable coastal/frost protected habitat present.	Not Expected; no suitable coastal/frost protected habitat present.	Not Expected; no suitable coastal/frost protected habitat present.
<i>Speyeria zerene myrtleae</i> Myrtle's silverspot butterfly	FE/None G5T1/S1	Restricted to the foggy, coastal dunes/hills of the Point Reyes peninsula; extirpated from coastal San Mateo County. Larval foodplant thought to be <i>Viola adunca</i> .	Not Expected; coastal dune habitats are not present.	Not Expected; coastal dune habitats are not present.	Not Expected; coastal dune habitats are not present.	Not Expected; coastal dune habitats are not present.	Not Expected; coastal dune habitats are not present.	Not Expected; coastal dune habitats are not present.	Not Expected; coastal dune habitats are not present.	Not Expected; coastal dune habitats are not present.	Not Expected; coastal dune habitats are not present.	Not Expected; coastal dune habitats are not present.	Not Expected; coastal dune habitats are not present.
<i>Syncaris pacifica</i> California freshwater shrimp	FE/SE G2/S2	Endemic to Marin, Napa, and Sonoma counties. Found in low elevation, low gradient streams where riparian cover is moderate to heavy. Shallow pools away from main streamflow. Winter: undercut banks with exposed roots. Summer: leafy branches touching water.	Not Expected; no suitable aquatic habitats present.	Low Potential;2 historical CNDDDB occurrences within 5 miles of site and suitable aquatic habitat present.	Low Potential; suitable aquatic habitat is present.	Not Expected; 2 historical CNDDDB occurrences within 5 miles of site but no suitable aquatic habitat is present.	Low Potential;3 historical CNDDDB occurrences within 5 miles suitable aquatic habitat is present.	Not Expected; no suitable aquatic habitats present.	Low Potential;5 historical CNDDDB occurrences within 5 miles suitable aquatic habitat is present.	Present; 5 historical CNDDDB occurrences within 5 miles of site, including 1 occurrence in Sonoma Creek within the BSA.	Low Potential; suitable aquatic habitat is present.	Not Expected; no suitable aquatic habitats present.	Low Potential;4 historical CNDDDB occurrences within 5 miles, suitable aquatic habitat is present.



Scientific Name Common Name	Status Fed/ State ESA CDFW	Habitat Requirements	GEY	GUE	LAR	FOR	GRA	SAN	GLE	AGU	PEN	PET	SON
<b>Fish</b>													
<i>Acipenser medirostris</i> pop. 1 greensturgeon – southern DPS	FT/None G2/S1	Spawning site fidelity. Spawns in the Sacramento, Feather and Yuba Rivers. Presence in upper Stanislaus and San Joaquin Rivers may indicate spawning. Non-spawning adults occupy marine/estuarine waters. Delta Estuary is important for rearing juveniles. Spawning occurs primarily in cool (11-15 C) sections of mainstem rivers in deep pools (8-9 meters) with substrate containing small to medium sized sand, gravel, cobble, or boulder.	<b>Not Expected;</b> suitable habitatis not present.	<b>Not Expected;</b> suitable habitatis not present.	<b>Not Expected;</b> suitable habitatis not present.	<b>Not Expected;</b> suitable habitatis not present.	<b>Not Expected;</b> suitable habitatis not present.	<b>Not Expected;</b> suitable habitatis not present.	<b>Not Expected;</b> suitable habitatis not present.	<b>Not Expected;</b> suitable habitatis not present.	<b>Not Expected;</b> suitable habitatis not present.	<b>Not Expected;</b> suitable habitatis not present.	<b>Not Expected;</b> suitable habitatis not present.
<i>Eucyclogobius newberryi</i> tidewater goby	FE/None G3/S3	Brackish water habitats along the California coast from Agua Hedionda Lagoon, San Diego County to the mouth of the Smith River. Found in shallow lagoons and lower stream reaches, they need fairly still but not stagnant water and high oxygen levels.	<b>Not Expected;</b> suitable brackish waterhabitat is not present.	<b>Not Expected;</b> suitable brackish waterhabitat is not present.	<b>Not Expected;</b> suitable brackish waterhabitat is not present.	<b>Not Expected;</b> suitable brackish waterhabitat is not present.	<b>Not Expected;</b> suitable brackish waterhabitat is not present.	<b>Not Expected;</b> suitable brackish waterhabitat is not present.	<b>Not Expected;</b> suitable brackish waterhabitat is not present.	<b>Not Expected;</b> suitable brackish waterhabitat is not present.	<b>Not Expected;</b> suitable brackish waterhabitat is not present.	<b>Not Expected;</b> suitable brackish waterhabitat is not present.	<b>Not Expected;</b> suitable brackish waterhabitat is not present.
<i>Hesperoleucus parvipinnis</i> Gualala roach	None/None G3/S3 SSC	Confined to the Gualala River and its tributaries. Warm water adapted.	<b>Not Expected;</b> Suitable aquatic habitat is not present.	<b>Low Potential;</b> suitable aquatic habitat is present.	<b>Low Potential;</b> suitable aquatic habitat is present.	<b>Not Expected;</b> Suitable aquatic habitat is not present.	<b>Low Potential;</b> suitable aquatic habitat is present.	<b>Low Potential;</b> suitable aquatic habitat is present.	<b>Low Potential;</b> suitable aquatic habitat is present.	<b>Low Potential;</b> suitable aquatic habitat is present.	<b>Low Potential;</b> suitable aquatic habitat is present.	<b>Not Expected;</b> Suitable aquatic habitat is not present.	<b>Low Potential;</b> suitable aquatic habitat is present.
<i>Hesperoleucus venustus</i> <i>navarroensis</i> northern coastal roach	None/None GNRT3/S3 SSC	Habitat generalists. Found generally in a wide variety of habitats in the Navarro River and Russian River basins where there is cover (e.g. fallen trees) and where alien predators are absent. Most abundant in tributaries with clear, well oxygenated water with dominant substrates of cobble and boulder, and shallow depths (average 10-50 cm) with pools up to 1 m deep.	<b>Not Expected;</b> Suitable aquatic habitat is not present.	<b>Low Potential;</b> suitable aquatic habitat is present.	<b>Low Potential;</b> suitable aquatic habitat is present.	<b>Not Expected;</b> Suitable aquatic habitat is not present.	<b>Low Potential;</b> suitable aquatic habitat is present.	<b>Low Potential;</b> suitable aquatic habitat is present.	<b>Low Potential;</b> suitable aquatic habitat is present.	<b>Low Potential;</b> suitable aquatic habitat is present.	<b>Low Potential;</b> suitable aquatic habitat is present.	<b>Not Expected;</b> Suitable aquatic habitat is not present.	<b>Low Potential;</b> suitable aquatic habitat is present.
<i>Hesperoleucus venustus</i> <i>subditus</i> southern coastal roach	None/None GNRT2/S2 SSC	Found in the drainages of Tomales Bay and northern San Francisco Bay in the north, and drainages of Monterey Bay in the south.	<b>Not Expected;</b> Suitable aquatic habitat is not present.	<b>Low Potential;</b> suitable aquatic habitat is present.	<b>Low Potential;</b> suitable aquatic habitat is present.	<b>Not Expected;</b> Suitable aquatic habitat is not present.	<b>Low Potential;</b> suitable aquatic habitat is present.	<b>Low Potential;</b> suitable aquatic habitat is present.	<b>Low Potential;</b> suitable aquatic habitat is present.	<b>Low Potential;</b> suitable aquatic habitat is present.	<b>Low Potential;</b> suitable aquatic habitat is present.	<b>Not Expected;</b> Suitable aquatic habitat is not present.	<b>Low Potential;</b> suitable aquatic habitat is present.
<i>Hypomesus transpacificus</i> Delta smelt	FT/SE G1/S1	Sacramento-San Joaquin Delta. Seasonally in Suisun Bay, Carquinez Strait and San Pablo Bay. Seldom found at salinities > 10 ppt. Most often at salinities < 2ppt.	<b>Not Expected;</b> Suitable aquatic habitat is not present.	<b>Not Expected;</b> Suitable aquatic habitat is not present.	<b>Not Expected;</b> Suitable aquatic habitat is not present.	<b>Not Expected;</b> Suitable aquatic habitat is not present.	<b>Not Expected;</b> Suitable aquatic habitat is not present.	<b>Not Expected;</b> Suitable aquatic habitat is not present.	<b>Not Expected;</b> Suitable aquatic habitat is not present.	<b>Not Expected;</b> Suitable aquatic habitat is not present.	<b>Not Expected;</b> Suitable aquatic habitat is not present.	<b>Not Expected;</b> Suitable aquatic habitat is not present.	<b>Not Expected;</b> Suitable aquatic habitat is not present.

Sonoma County  
Rezone Sites for Housing Project

Scientific Name Common Name	Status Fed/ State ESA CDFW	Habitat Requirements	GEY	GUE	LAR	FOR	GRA	SAN	GLE	AGU	PEN	PET	SON	
<i>Hysteroecarpus traskii</i> pomo Russian River tuleperch	None/None G5T4/S4 SSC	Low elevation streams of the Russian River system. Requires clear, flowing water with abundant cover. They also require deep (> 1 m) pool habitat.	<b>Not Expected;</b> suitable aquatic habitat is not present.	<b>Low Potential;</b> 1 CNDDDB occurrence approximately 3.3 miles east of site in Russian River and Fife Creek.	<b>Not Expected;</b> streams are present onsite but are not part of Russian River system.	<b>Not Expected;</b> 1 CNDDDB occurrence within 5 miles of site but no suitable aquatic habitat is present.	<b>Not Expected;</b> streams are present onsite but are not part of Russian River system.	<b>Not Expected;</b> no suitable aquatic habitat is present.	<b>Not Expected;</b> present onsite but are not part of Russian River system.	<b>Not Expected;</b> streams are present onsite but are not part of Russian River system.	<b>Not Expected;</b> streams are present onsite but are not part of Russian River system.	<b>Not Expected;</b> no suitable aquatic habitat is present.	<b>Not Expected;</b> present onsite but are not part of Russian River system.	
<i>Mylopharodon conocephalus</i> hardhead	None/None G3/S3 SSC	Low to mid-elevation streams in the Sacramento-San Joaquin drainage. Also present in the Russian River. Clear, deep pools with sand-gravel- boulder bottoms and slow water velocity. Not found where exotic centrarchids predominate.	<b>Not Expected;</b> no suitable aquatic habitat is present.	<b>Low Potential;</b> suitable aquatic habitat is present.	<b>Low Potential;</b> suitable aquatic habitat is present.	<b>Low Potential;</b> suitable aquatic habitat is present.	<b>Low Potential;</b> suitable aquatic habitat is present.	<b>Low Potential;</b> suitable aquatic habitat is present.	<b>Low Potential;</b> suitable aquatic habitat is present.	<b>Low Potential;</b> suitable aquatic habitat is present.	<b>Low Potential;</b> suitable aquatic habitat is present.	<b>Not Expected;</b> no suitable aquatic habitat is present.	<b>Low Potential;</b> suitable aquatic habitat is present.	
<i>Oncorhynchus kisutch</i> pop. 4 coho salmon - central California coast ESU	FE/SE G5T2Q/S2	Federal listing = pops between Punta Gorda & San Lorenzo River. State listing = pops south of Punta Gorda. Require beds of loose, silt-free, coarse gravel for spawning. Also need cover, cool water & sufficient dissolved oxygen.	<b>Not Expected;</b> no suitable aquatic habitat is present onsite.	<b>Present;</b> 6 CNDDDB occurrences within 5 miles and Fife creek is designated critical habitat.	<b>Present;</b> 1 CNDDDB occurrence within the BSA in Mark West Creek.	<b>Not Expected;</b> 4 CNDDDB occurrence within 5 miles but no suitable aquatic habitat is present.	<b>Moderate Potential;</b> 2 CNDDDB occurrence within 5 miles and suitable aquatic habitat is present.	<b>Not Expected;</b> suitable aquatic habitat is not present.	<b>Low Potential;</b> suitable aquatic habitat is present.	<b>Low Potential;</b> suitable aquatic habitat is present.	<b>Low Potential;</b> suitable aquatic habitat is present.	<b>Low Potential;</b> suitable aquatic habitat is present.	<b>Not Expected;</b> no suitable aquatic habitat is present.	<b>Low Potential;</b> suitable aquatic habitat is present.
<i>Oncorhynchus mykiss irideus</i> pop. 8 steelhead – central California coast DPS	ST/None G5T2T3Q/S2S3	DPS includes all naturally spawned populations of steelhead (and their progeny) in streams from the Russian River to Aptos Creek, Santa Cruz County, California (inclusive). Also includes the drainages of San Francisco and San Pablo Bays.	<b>Not Expected;</b> no suitable aquatic habitat is present onsite.	<b>Present;</b> 2 CNDDDB occurrences within 5 miles and Fife creek is designated critical habitat.	<b>Moderate Potential;</b> suitable aquatic habitat is present.	<b>Not Expected;</b> 1 CNDDDB occurrence within 5 miles but no suitable aquatic habitat is present.	<b>Low Potential;</b> suitable aquatic habitat is present.	<b>Not Expected;</b> no suitable aquatic habitat is present.	<b>Moderate Potential;</b> 3 CNDDDB occurrence within 5 miles and suitable aquatic habitat is present.	<b>Moderate Potential;</b> 2 CNDDDB occurrences within 5 miles and suitable aquatic habitat is present.	<b>Moderate Potential;</b> 2 CNDDDB occurrences within 5 miles and suitable aquatic habitat is present.	<b>Not Expected;</b> no suitable aquatic habitat is present.	<b>Low Potential;</b> suitable aquatic habitat is present.	
<i>Pogonichthys macrolepidotus</i> Sacramento splittail	None/None GNR/S3 SSC	Endemic to the lakes and rivers of the Central Valley, but now confined to the Delta, Suisun Bay and associated marshes. Slow moving river sections, dead end sloughs. Requires flooded vegetation for spawning and foraging for young.	<b>Not Expected;</b> no suitable marsh habitat is present onsite.	<b>Not Expected;</b> no suitable marsh habitat is present onsite.	<b>Not Expected;</b> no suitable marsh habitat is present onsite.	<b>Not Expected;</b> no suitable marsh habitat is present onsite.	<b>Not Expected;</b> no suitable marsh habitat is present onsite.	<b>Not Expected;</b> no suitable marsh habitat is present onsite.	<b>Not Expected;</b> no suitable marsh habitat is present onsite.	<b>Not Expected;</b> no suitable marsh habitat is present onsite.	<b>Low Potential;</b> 1 CNDDDB occurrence approximately 3.3 miles northeast of site (1999). Occurrence is downstream from site.	<b>Not Expected;</b> no suitable marsh habitat is present onsite.	<b>Not Expected;</b> no suitable marsh habitat is present onsite.	
<i>Spirinchus thaleichthys</i> longfin smelt	FC/ST G5/S1	Euryhaline, nektonic & anadromous. Found in open waters of estuaries, mostly in middle or bottom of water column. Prefer salinities of 15-30 ppt, but can be found in completely freshwater to almost pure seawater.	<b>Not Expected;</b> no suitable estuary habitat is present onsite.	<b>Not Expected;</b> no suitable estuary habitat is present onsite.	<b>Not Expected;</b> no suitable estuary habitat is present onsite.	<b>Not Expected;</b> no suitable estuary habitat is present onsite.	<b>Not Expected;</b> no suitable estuary habitat is present onsite.	<b>Not Expected;</b> no suitable estuary habitat is present onsite.	<b>Not Expected;</b> no suitable estuary habitat is present onsite.	<b>Not Expected;</b> no suitable estuary habitat is present onsite.	<b>Not Expected;</b> no suitable estuary habitat is present onsite.	<b>Not Expected;</b> no suitable estuary habitat is present onsite.	<b>Not Expected;</b> no suitable estuary habitat is present onsite.	

Scientific Name Common Name	Status Fed/ State ESA CDFW	Habitat Requirements	GEY	GUE	LAR	FOR	GRA	SAN	GLE	AGU	PEN	PET	SON
<i>Thaleichthys pacificus</i> eulachon	FT/None G5/S2	Found in Klamath River, Mad River, Redwood Creek, and in small numbers in Smith River and Humboldt Bay tributaries. Spawn in lower reaches of coastal rivers with moderate water velocities and bottom of pea-sized gravel, sand, and woody debris.	<b>Not Expected;</b> no suitable coastal river habitat is present.	<b>Not Expected;</b> no suitable coastal river habitat is present.	<b>Not Expected;</b> no suitable coastal river habitat is present.	<b>Not Expected;</b> no suitable coastal river habitat is present.	<b>Not Expected;</b> no suitable coastal river habitat is present.	<b>Not Expected;</b> no suitable coastal river habitat is present.	<b>Not Expected;</b> no suitable coastal river habitat is present.	<b>Not Expected;</b> no suitable coastal river habitat is present.	<b>Not Expected;</b> no suitable coastal river habitat is present.	<b>Not Expected;</b> no suitable coastal river habitat is present.	<b>Not Expected;</b> no suitable coastal river habitat is present.
<b>Reptiles</b>													
<i>Emys marmorata</i> western pond turtle	None/None G3G4/S3 SSC	A thoroughly aquatic turtle of ponds, marshes, rivers, streams and irrigation ditches, usually with aquatic vegetation, below 6000 ft elevation. Needs basking sites and suitable (sandy banks or grassy open fields) upland habitat up to 0.5 km from water for egg-laying.	<b>Not Expected;</b> 3 CNDDDB occurrences within 5 miles of site, including 1 occurrence approximately 0.7 miles northeast of site in Russian River, but no suitable aquatic habitat is present.	<b>Moderate Potential;</b> 8 CNDDDB occurrences within 5 miles of site and suitable aquatic habitat present.	<b>Low Potential;</b> 15 CNDDDB occurrences within 5 miles of site including one historical occurrence in Mark West Creek within the BSA (1909).	<b>Low Potential;</b> 8 CNDDDB occurrences within 5 miles of site suitable upland riparian habitat is present.	<b>Low Potential;</b> 8 CNDDDB occurrences within 5 miles suitable aquatic habitat is present.	<b>Low Potential;</b> 8 CNDDDB occurrences within 5 miles suitable aquatic habitat is present.	<b>Low Potential;</b> 2 CNDDDB occurrences within 5 miles suitable aquatic habitat is present.	<b>Low Potential;</b> 1 CNDDDB occurrence approximately 1.6 miles southeast of site and suitable aquatic habitat present.	<b>High Potential;</b> 9 CNDDDB occurrences within 5 miles of site, including one occurrence (2006) and suitable aquatic habitat present.	<b>Not Expected;</b> 11 CNDDDB occurrences within 5 miles of site, including one occurrence approximately 1.3 miles south but no suitable aquatic habitat is present.	<b>Low Potential;</b> 4 CNDDDB occurrences within 5 miles of site, suitable aquatic habitat is present.
<b>Amphibians</b>													
<i>Ambystoma californiense</i> <i>pop. 3</i> California tigersalamander – Sonoma County DPS	FE/ST G2G3/S2S3 SSC	Central Valley DPS federally listed as threatened. Santa Barbara and Sonoma counties DPS federally listed as endangered. Need underground refuges, especially ground squirrel burrows, and vernal pools or other seasonal water sources for breeding.	<b>Not Expected;</b> no suitable aquatic habitat is present and there are no known occurrences within 5 miles.	<b>Low Potential;</b> suitable aquatic habitat present, but there are no known occurrences within 5 miles of site.	<b>Low Potential;</b> 2 CNDDDB occurrences within 5 miles and critical habitat approximately 0.5 miles to the west and aquatic habitat is present.	<b>Low Potential;</b> site is adjacent to green Valley Creek approximately 300 feet to the southeast, critical habitat is approximately 2.8 miles east, and riparian habitats are present.	<b>Low Potential;</b> 9 CNDDDB occurrences within 5 miles from critical habitat approximately 1.6 miles east of site, and aquatic habitat is present.	<b>Present;</b> 75 CNDDDB occurrences within 5 miles of site, including 3 presumed extant occurrences within the BSA.	<b>Low Potential;</b> suitable aquatic habitat present, but there are no known occurrences within 5 miles of site.	<b>Low Potential;</b> suitable aquatic habitat present, but there are no known occurrences within 5 miles of site.	<b>High Potential;</b> 37 CNDDDB occurrences within 5 miles of the site, including one historical occurrence within the BSA (1856). Suitable aquatic habitat present and site is within critical habitat.	<b>Low Potential;</b> 2 CNDDDB occurrences within 5 miles of site, including one historical occurrence within the BSA (1856), however suitable aquatic habitat is not present.	<b>Low Potential;</b> suitable aquatic habitat present, and there is one known occurrence within 5 miles.
<i>Dicamptodon ensatus</i> California giantsalamander	None/None G2G3/S2S3 SSC	Known from wet coastal forests near streams and seeps from Mendocino County south to Monterey County, and east to Napa County. Aquatic larvae found in cold, clear streams, occasionally in lakes and ponds. Adults known from wet forests under rocks and logs near streams and lakes.	<b>Low Potential;</b> 5 CNDDDB occurrences within 5 miles, including one occurrence in Miller Creek approximately 1.4 miles east.	<b>High Potential;</b> 14 CNDDDB occurrences within 5 miles, and suitable aquatic habitat is present.	<b>Low Potential;</b> suitable aquatic habitat is present.	<b>Low Potential;</b> 5 CNDDDB occurrences within 5 miles, and suitable aquatic habitat is present.	<b>Moderate Potential;</b> 2 CNDDDB occurrences within 5 miles and suitable aquatic habitat is present.	<b>Low Potential;</b> suitable aquatic habitat is present.	<b>Moderate Potential;</b> 8 CNDDDB occurrences within 5 miles including one occurrence approximately 1 mile northeast, and suitable aquatic habitat is present.	<b>Moderate Potential;</b> 5 CNDDDB occurrences within 5 miles, and suitable aquatic habitat is present.	<b>Low Potential;</b> 2 CNDDDB occurrences within 5 miles, and suitable aquatic habitat is present.	<b>Not Expected;</b> no suitable aquatic habitat present and site is isolated by development.	<b>Low Potential;</b> 1 CNDDDB occurrence and suitable aquatic habitat is present.

Sonoma County  
**Rezone Sites for Housing Project**

Scientific Name Common Name	Status Fed/ State ESA CDFW	Habitat Requirements	GEY	GUE	LAR	FOR	GRA	SAN	GLE	AGU	PEN	PET	SON
<i>Rana boylei</i> pop.1 foothill yellow-legged frog – north coast DPS	None/None G3TNRQ/S4 SSC	Partly-shaded, shallow streams and riffles with a rocky substrate in a variety of habitats. Needs at least some cobble-sized substrate for egg-laying. Needs at least 15 weeks to attain metamorphosis.	<b>Not Expected;</b> 11 CNDDDB occurrences within 5 miles, occurrences within 5 miles, however suitable aquatic habitat is not present.	<b>Moderate Potential;</b> 17 CNDDDB occurrences within 5 miles, and suitable aquatic habitatis present.	<b>Moderate Potential;</b> 5 CNDDDB occurrences within 5 miles, and suitable aquatic habitatis present.	<b>Low Potential;</b> 4 CNDDDB occurrences within 5 miles, and suitable aquatic habitatis present.	<b>Low Potential;</b> 3 CNDDDB occurrences within 5 miles, and suitable aquatic habitatis present.	<b>Low Potential;</b> 4 CNDDDB occurrences within 5 miles, and suitable aquatic habitatis present.	<b>Low Potential;</b> 8 CNDDDB occurrences within 5 miles, and suitable aquatic habitatis present.	<b>Low Potential;</b> 4 CNDDDB occurrences within 5 miles, and suitable aquatic habitatis present.	<b>Moderate Potential;</b> 10 CNDDDB occurrences within 5 miles, and suitable aquatic habitatis present.	<b>Not Expected;</b> 5 CNDDDB occurrence within 5 miles, but suitable aquatic habitatis not present.	<b>Low Potential;</b> 1 CNDDDB occurrences within 5 miles, and suitable aquatic habitatis present.
<i>Rana draytonii</i> California red-legged frog	FT/None G2G3/S2S3 SSC	Lowlands and foothills in or near permanent sources of deep water with dense, shrubby or emergent riparian vegetation. Requires 11-20 weeks of permanent water for larval development. Must have access to estivation habitat.	<b>Low Potential;</b> 11 CNDDDB occurrences within 5 miles and suitable upland habitat may be present.	<b>Moderate Potential;</b> 2 CNDDDB occurrences within 5 miles and suitable aquatic habitatis present.	<b>Low Potential;</b> suitable aquatic habitat is present.	<b>Low Potential;</b> suitable aquatic habitat is present.	<b>Low Potential;</b> suitable aquatic habitat is present.	<b>Low Potential;</b> 3 CNDDDB occurrences within 5 miles and suitable aquatic habitatis present.	<b>Low Potential;</b> 8 CNDDDB occurrences within 5 miles and suitable aquatic habitatis present.	<b>Low Potential;</b> 3 CNDDDB occurrences within 5 miles and suitable aquatic habitatis present.	<b>Low Potential;</b> 18 CNDDDB occurrences within 5 miles and suitable aquatic habitatis present.	<b>Low Potential;</b> 11 CNDDDB occurrences within 5 miles and suitable aquatic habitatis present.	<b>Low Potential;</b> 3 CNDDDB occurrences within 5 miles and suitable upland habitat may be present.
<i>Taricha rivularis</i> red-bellied newt	None/None G2/S2 SSC	Coastal drainages from Humboldt County south to Sonoma County, inland to Lake County. Isolated population of uncertain origin in Santa Clara County. Lives in interstitial habitats, juveniles generally underground, adults active at surface in moist environments. Will migrate over 1 km to breed, typically in streams with moderate flow and clean, rocky substrate.	<b>Not Expected;</b> suitable aquatic habitats are not present. present.	<b>Moderate Potential;</b> 2 CNDDDB occurrences within 5 miles and suitable aquatic habitat present.	<b>Low Potential;</b> 3 CNDDDB occurrences within 5 miles, including one occurrence at Mark West Creek approximately 1 mile to the west.	<b>Low Potential;</b> suitable aquatic habitat is present.	<b>Low Potential;</b> suitable aquatic habitat is present.	<b>Low Potential;</b> suitable aquatic habitat is present.	<b>Low Potential;</b> 1 CNDDDB occurrences within 5 miles and suitable aquatic habitatis present.	<b>Low Potential;</b> 1 CNDDDB occurrence within 5 miles and suitable aquatic habitatis present.	<b>Low Potential;</b> 1 CNDDDB occurrence and suitable aquatic habitat is present.	<b>Not Expected;</b> 1 CNDDDB occurrence within 5 miles of site but suitable aquatic habitat is not present.	<b>Low Potential;</b> suitable aquatic habitat is present.
<b>Birds</b>													
<i>Accipiter cooperii</i> Cooper's hawk	None/None G5/S4 WL	Woodland, chiefly of open, interrupted or marginal type. Nest sites mainly in riparian growths of deciduous trees, as in canyon bottoms on river flood-plains; also, live oaks.	<b>Low Potential;</b> suitable woodland habitat is present.	<b>Low Potential;</b> suitable woodland habitat is present.	<b>Low Potential;</b> suitable woodland habitat is present.	<b>Low Potential;</b> suitable woodland habitat is present.	<b>Low Potential;</b> suitable woodland habitat is present.	<b>Low Potential;</b> suitable woodland habitat is present.	<b>Low Potential;</b> suitable woodland habitat is present.	<b>Low Potential;</b> suitable woodland habitat is present.	<b>Low Potential;</b> suitable woodland habitat is present.	<b>Low Potential;</b> suitable woodland habitat is present.	<b>Low Potential;</b> suitable woodland habitat is present.
<i>Accipiter striatus</i> sharp-shinned hawk	None/None G5/S4 WL	Ponderosa pine, black oak, riparian deciduous, mixed conifer, and Jeffrey pine habitats. Prefers riparian areas. North-facing slopes with plucking perches are critical requirements. Nests usually within 275 ft of water.	<b>Low Potential;</b> suitable breeding and foraging habitatis present.	<b>Moderate Potential;</b> suitable breeding and foraging habitatis present.	<b>Moderate Potential;</b> suitable breeding and foraging habitatis present.	<b>Moderate Potential;</b> suitable breeding and foraging habitatis present.	<b>Moderate Potential;</b> suitable breeding and foraging habitatis present.	<b>Moderate Potential;</b> suitable breeding and foraging habitatis present.	<b>Moderate Potential;</b> suitable breeding and foraging habitatis present.	<b>Moderate Potential;</b> suitable breeding and foraging habitatis present.	<b>Moderate Potential;</b> suitable breeding and foraging habitatis present.	<b>Moderate Potential;</b> suitable breeding and foraging habitatis present.	<b>Low Potential;</b> suitable breeding and foraging habitatis present.
<i>Agelaius tricolor</i> tricolored blackbird	None/ST G1G2/S1S2 SSC	Highly colonial species, most numerous in Central Valley & vicinity. Largely endemic to California. Requires open water, protected nesting substrate, and foraging area with insect prey within a few km of the colony.	<b>Not Expected;</b> suitable breeding habitat is not present.	<b>Low Potential;</b> suitable breeding and foraging habitat may be present.	<b>Low Potential;</b> suitable breeding and foraging habitat may be present.	<b>Low Potential;</b> 1 CNDDDB occurrence within 5 miles and suitable breeding and foraging habitat may be present.	<b>Low Potential;</b> 1 CNDDDB occurrence within 5 miles suitable breeding and foraging habitat may be present.	<b>Low Potential;</b> 2 CNDDDB occurrences within 5 miles suitable breeding and foraging habitat may be present.	<b>Low Potential;</b> suitable breeding and foraging habitat may be present.	<b>Low Potential;</b> suitable breeding and foraging habitat may be present.	<b>Low Potential;</b> 1 CNDDDB occurrence within 5 miles suitable breeding and foraging habitat may be present.	<b>Not Expected;</b> suitable breeding and foraging habitatis not present.	<b>Low Potential;</b> suitable breeding and foraging habitat may be present.

Scientific Name Common Name	Status Fed/ State ESA CDFW	Habitat Requirements	GEY	GUE	LAR	FOR	GRA	SAN	GLE	AGU	PEN	PET	SON
<i>Ammodramussavannarum</i> grasshopper sparrow	None/None G5/S3 SSC	Dense grasslands on rolling hills, lowland plains, in valleys and on hillsides on lower mountain slopes. Favors native grasslands with a mix of grasses, forbs and scattered shrubs. Loosely colonial when nesting.	<b>Low Potential;</b> suitable breeding and foraging habitat may be present.	<b>Low Potential;</b> suitable breeding and foraging habitat may be present.	<b>Low Potential;</b> suitable breeding and foraging habitat may be present.	<b>Low Potential;</b> suitable breeding and foraging habitat may be present.	<b>Low Potential;</b> suitable breeding and foraging habitat may be present.	<b>Low Potential;</b> suitable breeding and foraging habitat may be present.	<b>Low Potential;</b> suitable breeding and foraging habitat may be present.	<b>Low Potential;</b> suitable breeding and foraging habitat may be present.	<b>Low Potential;</b> suitable breeding and foraging habitat may be present.	<b>Low Potential;</b> suitable breeding and foraging habitat may be present.	<b>Low Potential;</b> suitable breeding and foraging habitat may be present.
<i>Aquila chrysaetos</i> golden eagle	None/None G5/S3 FP; WL	Rolling foothills, mountain areas, sage-juniper flats, and desert. Cliff-walled canyons provide nesting habitat in most parts of range; also, large trees in open areas.	<b>Low Potential;</b> suitable foraging habitat may be present.	<b>Low Potential;</b> suitable foraging habitat may be present.	<b>Low Potential;</b> suitable foraging habitat may be present.	<b>Low Potential;</b> suitable foraging habitat may be present.	<b>Low Potential;</b> suitable foraging habitat may be present.	<b>Low Potential;</b> suitable foraging habitat may be present.	<b>Low Potential;</b> suitable foraging habitat may be present.	<b>Low Potential;</b> suitable foraging habitat may be present.	<b>Low Potential;</b> 1 CNDDDB occurrence approximately 4.5 miles northeast, and suitable foraging habitat may be present.	<b>Low Potential;</b> suitable foraging habitat may be present.	<b>Low Potential;</b> suitable foraging habitat may be present.
<i>Athene cunicularia</i> burrowing owl	None/None G4/S3 SSC	Open, dry annual or perennial grasslands, deserts, and scrublands characterized by low-growing vegetation. Subterranean nester, dependent upon burrowing mammals, most notably, the California ground squirrel.	<b>Low Potential;</b> suitable open areas are present and 1 CNDDDB occurrence approximately 2.3 miles southeast.	<b>Low Potential;</b> suitable habitats are present.	<b>Low Potential;</b> 1 CNDDDB occurrence approximately 2.3 miles northwest and suitable habitats present.	<b>Low Potential;</b> 1 CNDDDB occurrence approximately 4.8 miles northeast and suitable habitats present.	<b>Low Potential;</b> suitable habitats are present.	<b>Low Potential;</b> 1 CNDDDB occurrence approximately 3.5 miles southeast and suitable habitats present.	<b>Low Potential;</b> 1 CNDDDB occurrence within 5 miles and suitable habitat is present.	<b>Low Potential;</b> suitable habitats are present.	<b>Low Potential;</b> 1 CNDDDB occurrence approximately 3.1 miles north and suitable habitat is present.	<b>Low Potential;</b> 1 CNDDDB occurrence approximately 2.9 miles southwest and suitable habitats present.	<b>Low Potential;</b> suitable habitats are present.
<i>Buteo regalis</i> ferruginous hawk	None/None G4/S3S4 WL	Open grasslands, sagebrush flats, desert scrub, low foothills and fringes of pinyon and juniper habitats. Eats mostly lagomorphs, ground squirrels, and mice. Population trends may follow lagomorph population cycles.	<b>Low Potential;</b> suitable foraging habitats present.	<b>Low Potential;</b> suitable foraging habitats present.	<b>Low Potential;</b> suitable foraging habitats present.	<b>Low Potential;</b> suitable foraging habitats present.	<b>Low Potential;</b> suitable foraging habitats present.	<b>Low Potential;</b> suitable foraging habitats present.	<b>Low Potential;</b> 1 CNDDDB occurrence approximately 3.8 miles southwest and suitable foraging habitats present.	<b>Low Potential;</b> 1 CNDDDB occurrence approximately 5 miles northwest and suitable foraging habitats present.	<b>Low Potential;</b> 1 CNDDDB occurrence approximately 4.9 miles northeast and suitable foraging habitats present.	<b>Low Potential;</b> suitable foraging habitats present.	<b>Low Potential;</b> suitable foraging habitat is present.
<i>Buteo swainsoni</i> Swainson's hawk	None/ST G5/S3	Breeds in grasslands with scattered trees, juniper-sage flats, riparian areas, savannahs, & agricultural or ranch lands with groves or lines of trees. Requires adjacent suitable foraging areas such as grasslands, or alfalfa or grain fields supporting rodent populations.	<b>Low Potential;</b> suitable breeding and foraging habitats present.	<b>Low Potential;</b> suitable breeding and foraging habitats present.	<b>Low Potential;</b> suitable breeding and foraging habitats present.	<b>Low Potential;</b> suitable breeding and foraging habitats present.	<b>Low Potential;</b> suitable breeding and foraging habitats present.	<b>Low Potential;</b> suitable breeding and foraging habitats present.	<b>Low Potential;</b> suitable breeding and foraging habitats present.	<b>Low Potential;</b> 1 CNDDDB occurrence approximately 4.2 miles south and suitable breeding and foraging habitats present.	<b>Low Potential;</b> suitable breeding and foraging habitats present.	<b>Low Potential;</b> 1 CNDDDB occurrence approximately 3.1 miles south and breeding and foraging habitat is present.	<b>Low Potential;</b> 1 CNDDDB occurrence approximately 2 miles south and suitable breeding and foraging habitat is present.
<i>Cerorhinca monocerata</i> rhinoceros auklet	None/None G5/S3 WL	Off-shore islands and rocks along the California coast. Nests in a burrow on undisturbed, forested and unforested islands, and probably in cliff caves on the mainland.	<b>Not Expected;</b> suitable breeding and foraging habitats not present.	<b>Not Expected;</b> suitable breeding and foraging habitats not present.	<b>Not Expected;</b> suitable breeding and foraging habitats not present.	<b>Not Expected;</b> suitable breeding and foraging habitats not present.	<b>Not Expected;</b> suitable breeding and foraging habitats not present.	<b>Not Expected;</b> suitable breeding and foraging habitats not present.	<b>Not Expected;</b> suitable breeding and foraging habitats not present.	<b>Not Expected;</b> suitable breeding and foraging habitats not present.	<b>Not Expected;</b> suitable breeding and foraging habitats not present.	<b>Not Expected;</b> suitable breeding and foraging habitats not present.	<b>Not Expected;</b> suitable breeding and foraging habitat is not present.

Sonoma County  
**Rezone Sites for Housing Project**

Scientific Name Common Name	Status Fed/ State ESA CDFW	Habitat Requirements	GEY	GUE	LAR	FOR	GRA	SAN	GLE	AGU	PEN	PET	SON
<i>Charadrius alexandrinus nivosus</i> western snowy plover	FT/None G3T3/S3 SSC	Sandy beaches, salt pond levees & shores of large alkali lakes. Needs sandy, gravelly or friable soils for nesting.	<b>Not Expected;</b> suitable breeding and foraging habitatis not present.	<b>Not Expected;</b> suitable breeding and foraging habitatis not present.	<b>Not Expected;</b> suitable breeding and foraging habitatis not present.	<b>Not Expected;</b> suitable breeding and foraging habitatis not present.	<b>Not Expected;</b> suitable breeding and foraging habitatis not present.	<b>Not Expected;</b> suitable breeding and foraging habitatis not present.	<b>Not Expected;</b> suitable breeding and foraging habitatis not present.	<b>Not Expected;</b> suitable breeding and foraging habitatis not present.	<b>Not Expected;</b> suitable breeding and foraging habitatis not present.	<b>Not Expected;</b> suitable breeding and foraging habitatis not present.	<b>Not Expected;</b> suitable breeding and foraging habitatis not present.
<i>Circus hudsonius</i> northern harrier	None/None G5/S3 SSC	Coastal salt and freshwater marsh. Nest and forage in grasslands, from salt grass in desert sink to mountain cienagas. Nests on ground in shrubby vegetation, usually at marsh edge; nest built of a large mound of sticks in wet areas.	<b>Low Potential;</b> suitable breeding and foraging habitatis present.	<b>Moderate Potential;</b> suitable breeding and foraging habitatis present.	<b>Moderate Potential;</b> suitable breeding and foraging habitatis present.	<b>Moderate Potential;</b> suitable breeding and foraging habitatis present.	<b>Moderate Potential;</b> suitable breeding and foraging habitatis present.	<b>Moderate Potential;</b> suitable breeding and foraging habitatis present.	<b>Moderate Potential;</b> suitable breeding and foraging habitatis present.	<b>Moderate Potential;</b> suitable breeding and foraging habitatis present.	<b>Moderate Potential;</b> suitable breeding and foraging habitatis present.	<b>Low Potential;</b> suitable breeding and foraging habitatis present.	<b>Low Potential;</b> suitable breeding and foraging habitatis present.
<i>Coccyzus americanus occidentalis</i> western yellow-billed cuckoo	FT/SE G5T2T3/S1	Riparian forest nester, along the broad, lower flood-bottoms of larger river systems. Nests in riparian jungles of willow, often mixed with cottonwoods, with lower story of blackberry, nettles, or wild grape.	<b>Not Expected;</b> suitable breeding and foraging habitatis not present.	<b>Not Expected;</b> suitable breeding and foraging habitatis not present.	<b>Not Expected;</b> suitable breeding and foraging habitatis not present.	<b>Not Expected;</b> suitable breeding and foraging habitatis not present.	<b>Not Expected;</b> suitable breeding and foraging habitatis not present.	<b>Not Expected;</b> 2 historical CNDDDB occurrences within 5 miles of site including one occurrence approximately 1.5 miles southwest of site (1972) but suitable breeding and foraging habitatis not present.	<b>Not Expected;</b> 1 CNDDDB occurrence within 5 miles of site but suitable breeding and foraging habitatis not present.	<b>Not Expected;</b> suitable breeding and foraging habitatis not present.	<b>Not Expected;</b> 2 CNDDDB occurrences within 5 miles, including historical one occurrence approximately 3 miles northeast (1975) but suitable breeding and foraging habitatis not present.	<b>Not Expected;</b> suitable breeding and foraging habitatis not present.	<b>Not Expected;</b> suitable breeding and foraging habitatis not present.
<i>Coturnicops noveboracensis</i> yellow rail	None/None G4/S1S2 SSC	Summer resident in eastern Sierra Nevada in Mono County. Freshwater marshlands.	<b>Not Expected;</b> suitable breeding and foraging habitatis not present.	<b>Not Expected;</b> suitable breeding and foraging habitatis not present.	<b>Not Expected;</b> 1 CNDDDB occurrence within 5 miles of site but no suitable breeding and foraging habitatis present.	<b>Not Expected;</b> suitable breeding and foraging habitatis not present.	<b>Not Expected;</b> suitable breeding and foraging habitatis not present.	<b>Not Expected;</b> suitable breeding and foraging habitatis not present.	<b>Not Expected;</b> suitable breeding and foraging habitatis not present.	<b>Not Expected;</b> 1 historical CNDDDB occurrence approximately 1.5 miles southeast of site (1898) but suitable breeding and foraging habitatis not present.	<b>Not Expected;</b> suitable breeding and foraging habitatis not present.	<b>Not Expected;</b> suitable breeding and foraging habitatis not present.	<b>Not Expected;</b> suitable breeding and foraging habitatis not present.
<i>Cypseloides niger</i> black swift	None/None G4/S2 SSC	Coastal belt of Santa Cruz and Monterey counties; central & southern Sierra Nevada; San Bernardino & San Jacinto mountains. Breeds in small colonies on cliffs behind or adjacent to waterfalls in deep canyons and sea-bluffs above the surf; forages widely.	<b>Not Expected;</b> suitable breeding and foraging habitatis not present.	<b>Not Expected;</b> suitable breeding and foraging habitatis not present.	<b>Not Expected;</b> suitable breeding and foraging habitatis not present.	<b>Not Expected;</b> suitable breeding and foraging habitatis not present.	<b>Not Expected;</b> suitable breeding and foraging habitatis not present.	<b>Not Expected;</b> suitable breeding and foraging habitatis not present.	<b>Not Expected;</b> 1 CNDDDB occurrence approximately 4.2 miles east of site but suitable breeding and foraging habitatis not present.	<b>Not Expected;</b> 1 CNDDDB occurrence within 5 miles of site but suitable breeding and foraging habitatis not present.	<b>Not Expected;</b> suitable breeding and foraging habitatis not present.	<b>Not Expected;</b> suitable breeding and foraging habitatis not present.	<b>Not Expected;</b> 1 CNDDDB occurrence (1898) and suitable breeding and foraging habitatis not present.

Scientific Name Common Name	Status Fed/ State ESA CDFW	Habitat Requirements	GEY	GUE	LAR	FOR	GRA	SAN	GLE	AGU	PEN	PET	SON
<i>Elanus leucurus</i> white-tailed kite	None/None G5/S3S4 FP	Rolling foothills and valley margins with scattered oaks & river bottomlands or marshes next to deciduous woodland. Open grasslands, meadows, or marshes for foraging close to isolated, dense-topped trees for nesting and perching.	<b>Moderate Potential;</b> suitable breeding and foraging habitat is present.	<b>Moderate Potential;</b> suitable breeding and foraging habitatis present.	<b>Moderate Potential;</b> suitable breeding and foraging habitatis present.	<b>Moderate Potential;</b> 1 CNDDB occurrence within 5 miles and suitable breeding and foraging habitatis present.	<b>Moderate Potential;</b> suitable breeding and foraging habitatis present.	<b>Moderate Potential;</b> 1 CNDDB occurrence approximately 1 mile north and suitable breeding and foraging habitatis present.	<b>Moderate Potential;</b> 2 CNDDB occurrences within 5 miles and suitable breeding and foraging habitatis present.	<b>Moderate Potential;</b> 1 CNDDB occurrence within 5 miles and suitable breeding and foraging habitatis present.	<b>Moderate Potential;</b> 1 CNDDB occurrence approximately 4.8 miles northeast and suitable breeding and foraging habitatis present.	<b>Moderate Potential;</b> suitable breeding and foraging habitatis present.	<b>Moderate Potential;</b> suitable breeding and foraging habitat is present.
<i>Eremophila alpestris actia</i> California hornedlark	None/None G5T4Q/S4 WL	Coastal regions, chiefly from Sonoma County to San Diego County. Also main part of San Joaquin Valley and east to foothills. Short-grass prairie, bald hills, mountain meadows, open coastal plains, fallow grain fields, alkali flats.	<b>Moderate Potential;</b> suitable breeding and foraging habitat is present.	<b>Moderate Potential;</b> suitable breeding and foraging habitatis present.	<b>Moderate Potential;</b> suitable breeding and foraging habitatis present.	<b>Moderate Potential;</b> suitable breeding and foraging habitatis present.	<b>Moderate Potential;</b> suitable breeding and foraging habitatis present.	<b>Moderate Potential;</b> suitable breeding and foraging habitatis present.	<b>Moderate Potential;</b> suitable breeding and foraging habitatis present.	<b>Moderate Potential;</b> suitable breeding and foraging habitatis present.	<b>Moderate Potential;</b> suitable breeding and foraging habitatis present.	<b>Moderate Potential;</b> suitable breeding and foraging habitatis present.	<b>Moderate Potential;</b> suitable breeding and foraging habitat is present.
<i>Falco peregrinus anatum</i> American peregrine falcon	FDR/SDR G4T4/S3S4 FP	Near wetlands, lakes, rivers, or other water; on cliffs, banks, dunes, mounds; also, human-made structures. Nest consists of a scrape or a depression or ledge in an open site.	<b>Moderate Potential;</b> suitable breeding and foraging habitat is present.	<b>Moderate Potential;</b> suitable breeding and foraging habitatis present.	<b>Moderate Potential;</b> suitable breeding and foraging habitatis present.	<b>Moderate Potential;</b> suitable breeding and foraging habitatis present.	<b>Moderate Potential;</b> suitable breeding and foraging habitatis present.	<b>Moderate Potential;</b> suitable breeding and foraging habitatis present.	<b>Moderate Potential;</b> suitable breeding and foraging habitatis present.	<b>Moderate Potential;</b> suitable breeding and foraging habitatis present.	<b>Moderate Potential;</b> suitable breeding and foraging habitatis present.	<b>Moderate Potential;</b> suitable breeding and foraging habitatis present.	<b>Moderate Potential;</b> suitable breeding and foraging habitat is present.
<i>Fratercula cirrhata</i> tufted puffin	None/None G5/S1S2 SSC	Open-ocean bird; nests along the coast on islands, islets, or (rarely) mainland cliffs. Requires sod or earth into which the birds can burrow, on island cliffs or grassy island slopes.	<b>Not Expected;</b> suitable breeding and foraging habitat is not present.	<b>Not Expected;</b> suitable breeding and foraging habitatis not present.	<b>Not Expected;</b> suitable breeding and foraging habitatis not present.	<b>Not Expected;</b> suitable breeding and foraging habitatis not present.	<b>Not Expected;</b> suitable breeding and foraging habitatis not present.	<b>Not Expected;</b> suitable breeding and foraging habitatis not present.	<b>Not Expected;</b> suitable breeding and foraging habitatis not present.	<b>Not Expected;</b> suitable breeding and foraging habitatis not present.	<b>Not Expected;</b> suitable breeding and foraging habitatis not present.	<b>Not Expected;</b> suitable breeding and foraging habitatis not present.	<b>Not Expected;</b> suitable breeding and foraging habitat is not present.
<i>Geothlypis trichasinuosa</i> saltmarsh common yellowthroat	None/None G5T3/S3 SSC	Resident of the San Francisco Bay region, in fresh and salt water marshes. Requires thick, continuous cover down to water surface for foraging; tall grasses, tule patches, willows for nesting.	<b>Not Expected;</b> suitable breeding and foraging habitat is not present.	<b>Not Expected;</b> suitable breeding and foraging habitatis not present.	<b>Not Expected;</b> suitable breeding and foraging habitatis not present.	<b>Not Expected;</b> suitable breeding and foraging habitatis not present.	<b>Not Expected;</b> suitable breeding and foraging habitatis not present.	<b>Not Expected;</b> suitable breeding and foraging habitatis not present.	<b>Not Expected;</b> suitable breeding and foraging habitatis not present.	<b>Not Expected;</b> suitable breeding and foraging habitatis not present.	<b>Not Expected;</b> 1 CNDDB occurrence approximately 5 miles south of site at Petaluma River Marsh but suitable breeding and foraging habitatis not present.	<b>Not Expected;</b> 2 CNDDB occurrence within 5 miles of site but suitable breeding and foraging habitatis not present.	<b>Not Expected;</b> 3 CNDDB occurrences within 5 miles but suitable breeding and foraging habitat is not present.
<i>Haliaeetus leucocephalus</i> bald eagle	FDR/SE G5/S3 FP	Ocean shore, lake margins, and rivers for both nesting and wintering. Most nests within 1 mile of water. Nests in large, old-growth, or dominant live tree with open branches, especially ponderosa pine. Roosts communally in winter.	<b>Not Expected;</b> suitable breeding and foraging habitat is not present.	<b>Not Expected;</b> suitable breeding and foraging habitatis not present.	<b>Not Expected;</b> suitable breeding and foraging habitatis not present.	<b>Not Expected;</b> suitable breeding and foraging habitatis not present.	<b>Not Expected;</b> suitable breeding and foraging habitatis not present.	<b>Not Expected;</b> suitable breeding and foraging habitatis not present.	<b>Not Expected;</b> suitable breeding and foraging habitatis not present.	<b>Not Expected;</b> suitable breeding and foraging habitatis not present.	<b>Not Expected;</b> suitable breeding and foraging habitatis not present.	<b>Not Expected;</b> suitable breeding and foraging habitatis not present.	<b>Not Expected;</b> suitable breeding and foraging habitat is not present.

Sonoma County  
Rezone Sites for Housing Project

Scientific Name Common Name	Status Fed/ State ESA CDFW	Habitat Requirements	GEY	GUE	LAR	FOR	GRA	SAN	GLE	AGU	PEN	PET	SON
<i>Laterallus jamaicensis coturniculus</i> California black rail	None/ST G3T1/S1 FP	Inhabits freshwater marshes, wet meadows and shallow margins of saltwater marshes bordering larger bays. Needs water depths of about 1 inch that do not fluctuate during the year and dense vegetation for nesting habitat.	<b>Not Expected;</b> suitable breeding and foraging habitat is not present.	<b>Not Expected;</b> suitable breeding and foraging habitat is not present.	<b>Not Expected;</b> suitable breeding and foraging habitat is not present.	<b>Not Expected;</b> suitable breeding and foraging habitat is not present.	<b>Not Expected;</b> suitable breeding and foraging habitat is not present.	<b>Not Expected;</b> suitable breeding and foraging habitat is not present.	<b>Not Expected;</b> suitable breeding and foraging habitat is not present.	<b>Not Expected;</b> suitable breeding and foraging habitat is not present.	<b>Not Expected;</b> suitable breeding and foraging habitat is not present.	<b>Not Expected;</b> 4 CNDDDB occurrences within 5 miles but suitable breeding and foraging habitat is not present.	<b>Not Expected;</b> suitable breeding and foraging habitat is not present.
<i>Melospiza melodiasamuelsis</i> San Pablo songsparrow	None/None G5T2/S2 SSC	Resident of salt marshes along the north side of San Francisco and San Pablo bays. Inhabits tidal sloughs in the Salicornia marshes; nests in Grindelia bordering slough channels.	<b>Not Expected;</b> suitable breeding and foraging habitat is not present.	<b>Not Expected;</b> suitable breeding and foraging habitat is not present.	<b>Not Expected;</b> suitable breeding and foraging habitat is not present.	<b>Not Expected;</b> suitable breeding and foraging habitat is not present.	<b>Not Expected;</b> suitable breeding and foraging habitat is not present.	<b>Not Expected;</b> suitable breeding and foraging habitat is not present.	<b>Not Expected;</b> suitable breeding and foraging habitat is not present.	<b>Not Expected;</b> suitable breeding and foraging habitat is not present.	<b>Not Expected;</b> 1 historical CNDDDB occurrence approximately 5 miles south of site (1940) and suitable breeding and foraging habitat is not present.	<b>Not Expected;</b> 1 historical CNDDDB occurrence approximately 2 miles east of site (1940) but suitable breeding and foraging habitat is not present.	<b>Not Expected;</b> 2 historical CNDDDB occurrences within 5 miles (1901, 1947) and suitable breeding and foraging habitat is not present.
<i>Nannopterum auritum</i> double-crested cormorant	None/None G5/S4 WL	Colonial nester on coastal cliffs, offshore islands, and along lake margins in the interior of the state. Nests along coast on sequestered islets, usually on ground with sloping surface, or in tall trees along lake margins.	<b>Not Expected;</b> suitable breeding and foraging habitat is not present.	<b>Not Expected;</b> suitable breeding and foraging habitat is not present.	<b>Not Expected;</b> suitable breeding and foraging habitat is not present.	<b>Not Expected;</b> suitable breeding and foraging habitat is not present.	<b>Not Expected;</b> suitable breeding and foraging habitat is not present.	<b>Not Expected;</b> suitable breeding and foraging habitat is not present.	<b>Not Expected;</b> suitable breeding and foraging habitat is not present.	<b>Not Expected;</b> suitable breeding and foraging habitat is not present.	<b>Not Expected;</b> suitable breeding and foraging habitat is not present.	<b>Not Expected;</b> suitable breeding and foraging habitat is not present.	<b>Not Expected;</b> suitable breeding and foraging habitat is not present.
<i>Pandion haliaetus</i> osprey	None/None G5/S4 WL	Ocean shore, bays, freshwater lakes, and larger streams. Large nests built in tree-tops within 15 miles of a good fish-producing body of water.	<b>Not Expected;</b> suitable breeding and foraging habitat is not present.	<b>Low Potential;</b> 3 CNDDDB occurrences including one occurrence approximately 2.4 miles east of site along Russian River.	<b>Not Expected;</b> suitable breeding and foraging habitat is not present.	<b>Not Expected;</b> 2 CNDDDB occurrences within 5 miles of site but no suitable breeding and foraging habitat.	<b>Not Expected;</b> 1 CNDDDB occurrence within 5 miles of site but suitable breeding and foraging habitat is not present.	<b>Not Expected;</b> suitable breeding and foraging habitat is not present.	<b>Not Expected;</b> suitable breeding and foraging habitat is not present.	<b>Not Expected;</b> suitable breeding and foraging habitat is not present.	<b>Not Expected;</b> suitable breeding and foraging habitat is not present.	<b>Not Expected;</b> suitable breeding and foraging habitat is not present.	<b>Not Expected;</b> suitable breeding and foraging habitat is not present.
<i>Pelecanus occidentalis californicus</i> California brown pelican	FDR/SDR G4T3T4/S3 FP	Colonial nester on coastal islands just outside the surf line. Nests on coastal islands of small to moderate size which afford immunity from attack by ground-dwelling predators. Roosts communally.	<b>Not Expected;</b> suitable breeding and foraging habitat is not present.	<b>Not Expected;</b> suitable breeding and foraging habitat is not present.	<b>Not Expected;</b> suitable breeding and foraging habitat is not present.	<b>Not Expected;</b> suitable breeding and foraging habitat is not present.	<b>Not Expected;</b> suitable breeding and foraging habitat is not present.	<b>Not Expected;</b> suitable breeding and foraging habitat is not present.	<b>Not Expected;</b> suitable breeding and foraging habitat is not present.	<b>Not Expected;</b> suitable breeding and foraging habitat is not present.	<b>Not Expected;</b> suitable breeding and foraging habitat is not present.	<b>Not Expected;</b> suitable breeding and foraging habitat is not present.	<b>Not Expected;</b> suitable breeding and foraging habitat is not present.
<i>Progne subis</i> purple martin	None/None G5/S3 SSC	Inhabits woodlands, low elevation coniferous forest of Douglas-fir, ponderosa pine, and Monterey pine. Nests in old woodpecker cavities mostly; also in human-made structures. Nest often located in tall, isolated tree/snag.	<b>Low Potential;</b> suitable breeding and foraging habitat is present.	<b>Low Potential;</b> suitable breeding and foraging habitat is present.	<b>Low Potential;</b> suitable breeding and foraging habitat is present.	<b>Low Potential;</b> suitable breeding and foraging habitat is present.	<b>Low Potential;</b> suitable breeding and foraging habitat is present.	<b>Low Potential;</b> suitable breeding and foraging habitat is present.	<b>Low Potential;</b> suitable breeding and foraging habitat is present.	<b>Low Potential;</b> suitable breeding and foraging habitat is present.	<b>Low Potential;</b> suitable breeding and foraging habitat is present.	<b>Low Potential;</b> suitable breeding and foraging habitat is present.	<b>Low Potential;</b> suitable breeding and foraging habitat is present.



Scientific Name Common Name	Status Fed/ State ESA CDFW	Habitat Requirements	GEY	GUE	LAR	FOR	GRA	SAN	GLE	AGU	PEN	PET	SON
<i>Rallus obsoletus</i> California Ridgway's rail	FE/SE G3T1/S1 FP	Salt water and brackish marshes traversed by tidal sloughs in the vicinity of San Francisco Bay. Associated with abundant growths of pickleweed, but feeds away from cover on invertebrates from mud-bottomed sloughs.	<b>Not Expected;</b> suitable breeding and foraging habitatis not present.	<b>Not Expected;</b> suitable breeding and foraging habitatis not present.	<b>Not Expected;</b> suitable breeding and foraging habitat is not present.	<b>Not Expected;</b> suitable breeding and foraging habitatis not present.	<b>Not Expected;</b> suitable breeding and foraging habitatis not present.	<b>Not Expected;</b> suitable breeding and foraging habitat is not present.	<b>Not Expected;</b> suitable breeding and foraging habitatis not present.	<b>Not Expected;</b> suitable breeding and foraging habitatis not present.	<b>Not Expected;</b> suitable breeding and foraging habitat is not present.	<b>Not Expected;</b> suitable breeding and foraging habitatis not present.	<b>Not Expected;</b> 1 CNDDDB occurrence within 5 miles of site but suitable breeding and foraging habitat is not present.
<i>Riparia riparia</i> bank swallow	None/ST G5/S2	Colonial nester; nests primarily in riparian and other lowland habitats west of the desert. Requires vertical banks/cliffs with fine-textured/sandy soils near streams, rivers, lakes, ocean to dig nesting hole.	<b>Not Expected;</b> suitable breeding habitat is not present.	<b>Not Expected;</b> suitable breeding habitat is not present.	<b>Not Expected;</b> suitable breeding habitat is not present.	<b>Not Expected;</b> suitable breeding habitat is not present.	<b>Not Expected;</b> suitable breeding habitat is not present.	<b>Not Expected;</b> suitable breeding habitat is not present.	<b>Not Expected;</b> 1 CNDDDB occurrence within 5 miles but suitable breeding habitat is not present.	<b>Not Expected;</b> 1 historical CNDDDB occurrence (1893) but suitable breeding habitat is not present.	<b>Not Expected;</b> suitable breeding habitat is not present.	<b>Not Expected;</b> suitable breeding habitat is not present.	<b>Not Expected;</b> 1 historical CNDDDB occurrence (1893) but suitable breeding habitat is not present.
<i>Strix occidentalis</i> northern spotted owl	FT/ST G3G4T3/S2	Old-growth forests or mixed stands of old-growth and mature trees. Occasionally in younger forests with patches of big trees. High, multistory canopy dominated by big trees, many trees with cavities or broken tops, woody debris, and space under canopy.	<b>Not Expected;</b> no CNDDDB spotted owl observations within 5 miles of site and suitable breeding and foraging habitatis not present.	<b>Low Potential;</b> CNDDDB spotted owl observations within 5 miles, including one observation approximately 0.5 miles south, but suitable breeding and foraging habitatis not present.	<b>Not Expected;</b> suitable breeding and foraging habitat is not present, and the site is isolated by development.	<b>Low Potential;</b> CNDDDB spotted owl observations approximately 1 mile west of site but suitable breeding and foraging habitatis not present.	<b>Not Expected;</b> CNDDDB spotted owl observations approximately 2.3 miles west but suitable breeding and foraging habitatis not present.	<b>Not Expected;</b> no CNDDDB spotted owl observations within 5 miles and suitable breeding and foraging habitat is not present.	<b>Not Expected;</b> CNDDDB spotted owl observations approximately 1.7 miles southwest but suitable breeding and foraging habitatis not present.	<b>Not Expected;</b> CNDDDB spotted owl observations in Sonoma Mountains approximately 3.3 miles east but suitable breeding and foraging habitatis not present.	<b>Not Expected;</b> no CNDDDB spotted owl observations within 5 miles of site and suitable breeding and foraging habitat is not present.	<b>Not Expected;</b> no CNDDDB spotted owl observations within 5 miles of site and suitable breeding and foraging habitatis not present.	<b>Not Expected;</b> CNDDDB spotted owl observations approximately 2.8 miles northeast but suitable breeding and foraging habitat is not present.
<b>Mammals</b>													
<i>Antrozous pallidus</i> pallid bat	None/None G4/S3 SSC	Deserts, grasslands, shrublands, woodlands and forests. Most common in open, dry habitats with rocky areas for roosting. Roosts must protect bats from high temperatures. Very sensitive to disturbance of roosting sites.	<b>Low Potential;</b> 4 CNDDDB occurrences within 5 miles of site and suitable habitatis present.	<b>Low Potential;</b> 1 CNDDDB occurrence approximately 4.9 miles southeast and suitable habitatis present.	<b>Low Potential;</b> 1 CNDDDB occurrence approximately 4.7 miles northeast and suitable habitatis present.	<b>Moderate Potential;</b> 2 CNDDDB occurrences within 5 miles of site, including one historical occurrence within the BSA and suitable habitat is present.	<b>Low Potential;</b> 2 CNDDDB occurrences within 5 miles and suitable habitat is present.	<b>Low Potential;</b> suitable habitatis present.	<b>Low Potential;</b> 1 CNDDDB occurrence approximately 1.3 miles west and suitable habitat is present.	<b>Low Potential;</b> 4 CNDDDB occurrences within 5 miles of site, including 1 occurrence approximately 0.7 miles south and suitable habitat is present.	<b>Low Potential;</b> 1 CNDDDB occurrence approximately 4.9 miles south and suitable habitat is present.	<b>Low Potential;</b> suitable habitatis present.	<b>Low Potential;</b> 3 CNDDDB occurrences within 5 miles of site, including 1 occurrence approximately 0.6 miles southwest and suitable habitatis present.
<i>Aplodontia rufa</i> Point Reyes mountain beaver	None/None G5T2/S2 SSC	Coastal area of Point Reyes in areas of springs or seepages. North-facing slopes of hills and gullies in areas overgrown with sword ferns and thimbleberries.	<b>Not Expected;</b> suitable breeding and foraging habitat is not present.	<b>Not Expected;</b> suitable breeding and foraging habitatis not present.	<b>Not Expected;</b> suitable breeding and foraging habitatis not present.	<b>Not Expected;</b> suitable breeding and foraging habitatis not present.	<b>Not Expected;</b> suitable breeding and foraging habitatis not present.	<b>Not Expected;</b> suitable breeding and foraging habitat is not present.	<b>Not Expected;</b> suitable breeding and foraging habitatis not present.	<b>Not Expected;</b> suitable breeding and foraging habitatis not present.	<b>Not Expected;</b> suitable breeding and foraging habitatis not present.	<b>Not Expected;</b> suitable breeding and foraging habitatis not present.	<b>Not Expected;</b> suitable breeding and foraging habitatis not present.

Sonoma County  
**Rezone Sites for Housing Project**

Scientific Name Common Name	Status Fed/ State ESA CDFW	Habitat Requirements	GEY	GUE	LAR	FOR	GRA	SAN	GLE	AGU	PEN	PET	SON
<i>Arborimus pomo</i> Sonoma tree vole	None/None G3/S3 SSC	North coast fog belt from Oregon border to Sonoma County. In Douglas-fir, redwood & montane hardwood-conifer forests. Feeds almost exclusively on Douglas-fir needles. Will occasionally take needles of grand fir, hemlock or spruce.	<b>Not Expected;</b> suitable breeding and foraging habitat is not present.	<b>Low Potential;</b> 6 CNDDDB occurrences within 5 miles and suitable habitat is present.	<b>Not Expected;</b> suitable breeding and foraging habitat is not present.	<b>Low Potential;</b> 1 CNDDDB occurrence within 5 miles and suitable habitat is present.	<b>Not Expected;</b> 2 CNDDDB occurrences within 5 miles of site but suitable breeding and foraging habitat is not present.	<b>Not Expected;</b> suitable breeding and foraging habitat is not present.	<b>Not Expected;</b> suitable breeding and foraging habitat is not present.	<b>Not Expected;</b> suitable breeding and foraging habitat is not present.	<b>Not Expected;</b> suitable breeding and foraging habitat is not present.	<b>Not Expected;</b> suitable breeding and foraging habitat is not present.	<b>Not Expected;</b> suitable breeding and foraging habitat is not present.
<i>Corynorhinus townsendii</i> Townsend's big-eared bat	None/None G4/S2 SSC	Throughout California in a wide variety of habitats. Most common in mesic sites. Roosts in the open, hanging from walls and ceilings. Roosting sites limiting. Extremely sensitive to human disturbance.	<b>Low Potential;</b> suitable habitat is present.	<b>Low Potential;</b> 1 CNDDDB occurrence approximately 2.2 miles north and suitable habitat is present.	<b>Low Potential;</b> 2 CNDDDB occurrences within 5 miles and suitable habitat is present.	<b>Low Potential;</b> 1 CNDDDB occurrence approximately 4.6 miles north and suitable habitat is present.	<b>Low Potential;</b> suitable habitat is present.	<b>Low Potential;</b> suitable habitat is present.	<b>Low Potential;</b> suitable habitat is present.	<b>Low Potential;</b> suitable habitat is present.	<b>Low Potential;</b> 1 CNDDDB occurrence approximately 4 miles south and suitable habitat is present.	<b>Low Potential;</b> 1 historical CNDDDB occurrence approximately 2 miles east and suitable habitat is present.	<b>Low Potential;</b> suitable habitat is present.
<i>Lasiurus blossevillii</i> western red bat	None/None G4/S3 SSC	Roosts primarily in trees, 2-40 ft above ground, from sea level up through mixed conifer forests. Prefers habitat edges and mosaics with trees that are protected from above and open below with open areas for foraging.	<b>Low Potential;</b> suitable habitat is present.	<b>Low Potential;</b> 1 CNDDDB occurrence approximately 4.9 miles southeast and suitable habitat is present.	<b>Low Potential;</b> suitable habitat is present.	<b>Low Potential;</b> 1 CNDDDB occurrence approximately 0.7 miles west and suitable habitat is present.	<b>Low Potential;</b> 1 CNDDDB occurrence approximately 3 miles northwest and suitable habitat is present.	<b>Low Potential;</b> suitable habitat is present.	<b>Low Potential;</b> suitable habitat is present.	<b>Low Potential;</b> suitable habitat is present.	<b>Low Potential;</b> suitable habitat is present.	<b>Low Potential;</b> suitable habitat is present.	<b>Low Potential;</b> suitable habitat is present.
<i>Pekania pennanti</i> fisher	None/None G5/S2S3 SSC	Intermediate to large-tree stages of coniferous forests and deciduous-riparian areas with high percent canopy closure. Uses cavities, snags, logs and rocky areas for cover and denning. Needs large areas of mature, dense forest.	<b>Not Expected;</b> suitable breeding and foraging habitat is not present.	<b>Not Expected;</b> suitable breeding and foraging habitat is not present.	<b>Not Expected;</b> suitable breeding and foraging habitat is not present.	<b>Not Expected;</b> suitable breeding and foraging habitat is not present.	<b>Not Expected;</b> suitable breeding and foraging habitat is not present.	<b>Not Expected;</b> suitable breeding and foraging habitat is not present.	<b>Not Expected;</b> suitable breeding and foraging habitat is not present.	<b>Not Expected;</b> suitable breeding and foraging habitat is not present.	<b>Not Expected;</b> suitable breeding and foraging habitat is not present.	<b>Not Expected;</b> suitable breeding and foraging habitat is not present.	<b>Not Expected;</b> suitable breeding and foraging habitat is not present.
<i>Reithrodontomys raviventris</i> salt-marsh harvestmouse	FE/SE G1G2/S1S2 FP	Only in the saline emergent wetlands of San Francisco Bay and its tributaries. Pickleweed is primary habitat, but may occur in other marsh vegetation types and in adjacent upland areas. Does not burrow; builds loosely organized nests. Requires higher areas for flood escape.	<b>Not Expected;</b> suitable wetland habitat is not present.	<b>Not Expected;</b> suitable wetland habitat is not present.	<b>Not Expected;</b> suitable wetland habitat is not present.	<b>Not Expected;</b> suitable wetland habitat is not present.	<b>Not Expected;</b> suitable wetland habitat is not present.	<b>Not Expected;</b> suitable wetland habitat is not present.	<b>Not Expected;</b> suitable wetland habitat is not present.	<b>Not Expected;</b> suitable wetland habitat is not present.	<b>Not Expected;</b> 1 CNDDDB occurrence approximately 4.8 miles southeast of site but suitable wetland habitat is not present.	<b>Not Expected;</b> 2 CNDDDB occurrences within 5 miles of site but suitable wetland habitat is not present.	<b>Not Expected;</b> suitable wetland habitat is not present.
<i>Sorex ornatus sinuosus</i> Suisun shrew	None/None G5T1T2Q/S1S2 SSC	Tidal marshes of the northern shores of San Pablo and Suisun bays. Require dense low-lying cover and driftwood and other litter above the mean high tide line for nesting and foraging.	<b>Not Expected;</b> suitable tidal marsh habitat is not present.	<b>Not Expected;</b> suitable tidal marsh habitat is not present.	<b>Not Expected;</b> suitable tidal marsh habitat is not present.	<b>Not Expected;</b> suitable tidal marsh habitat is not present.	<b>Not Expected;</b> suitable tidal marsh habitat is not present.	<b>Not Expected;</b> suitable tidal marsh habitat is not present.	<b>Not Expected;</b> suitable tidal marsh habitat is not present.	<b>Not Expected;</b> suitable tidal marsh habitat is not present.	<b>Not Expected;</b> suitable tidal marsh habitat is not present.	<b>Not Expected;</b> suitable tidal marsh habitat is not present.	<b>Not Expected;</b> suitable tidal marsh habitat is not present.

Scientific Name Common Name	Status Fed/ State ESA CDFW	Habitat Requirements	GEY	GUE	LAR	FOR	GRA	SAN	GLE	AGU	PEN	PET	SON
<i>Taxidea taxus</i> American badger	None/None G5/S3 SSC	Most abundant in drier open stages of most shrub, forest, and herbaceous habitats, with friable soils. Needs sufficient food, friable soils and open, uncultivated ground. Preys on burrowing rodents. Digs burrows.	<b>Not Expected;</b> suitable habitats not present.	<b>Not Expected;</b> suitable habitats not present.	<b>Not Expected;</b> suitable habitats not present.	<b>Not Expected;</b> suitable habitats not present.	<b>Not Expected; 2</b> CNDDC occurrences within 5 miles but suitable habitat is not present.	<b>Not Expected; 3</b> CNDDC occurrences within 5 miles but suitable habitat is not present.	<b>Not Expected; 1</b> CNDDB occurrence approximately 3.8 miles southwest of site but suitable habitat is not present.	<b>Not Expected;</b> suitable habitats not present.	<b>Not Expected; 4</b> CNDDB occurrences within 5 miles of site, including one occurrence approximately 0.8 miles southwest of site but suitable habitat is not present.	<b>Moderate Potential; 1</b> CNDDB occurrence approximately 400 feet north of site and suitable open habitat is present.	<b>Not Expected;</b> suitable habitats not present.
FT = Federally Threatened      SE = State Endangered FC = Federal Candidate Species      ST = State Threatened      FE = Federally Endangered      SR = State Rare FS = Federally Sensitive      SS = State Sensitive G-Rank/S-Rank = Global Rank and State Rank as per NatureServe and CDFW's CNDDB RareFind3 SSC = CDFW Species of Special Concern      FP = Fully Protected WL = Watch List DPS = Distinct Population Segment			USGS 7.5-minute quadrangles Reviewed: Geyserville (3812268), Cazadero (3812351), Healdsburg (3812257), Guerneville (3812258), Camp Meeker (3812248), Sebastopol (3812247), Santa Rosa (3812246), Cotati (3812236), Glen Ellen (3812235), Petaluma (3812226), Sonoma (3812234), Cloverdale (3812371), Asti (3812278), The Geysers (3812277), Jimtown (3812267), Warm Springs Dam (3812361), Tombs Creek (3812362), Arched Rock (3812342), Duncans Mills (3812341), Bodega Head (3812331), Valley Ford (3812238), Two Rock (3812237), Point Reyes NE (3812227), Inverness (3812217), San Geronimo (3812216), Novato (3812215), Petaluma River (3812225), Sears Point (3812224), Cuttings Wharf (3812223), Napa (3812233), Yountville (3812243), Rutherford (3812244), Kenwood (3812245), Calistoga (3812255), Mark West Springs (3812256), Mount St. Helena (3812266), Fort Ross (3812352)										

*This page intentionally left blank.*

# Appendix GEO

---

Paleontological Technical Information

## Appendix GEO: Paleontological Technical Information

### **Quaternary Young Alluvial Fan and Fluvial Deposits**

Middle to late Holocene alluvial fan and fluvial deposits (Q, Qal), mapped extensively throughout the Geyserville, Guerneville, Larkfield, Graton, and Santa Rosa Potential Sites, are composed of unconsolidated to moderately consolidated medium to coarse-grained sand, silt, and gravel. Middle to late Holocene alluvial fan deposits are typically too young (i.e., less than 5,000 years old) to preserve paleontological resources and are also determined to have a low paleontological sensitivity according to SVP (2010) standards. However, middle to late Holocene alluvial and fluvial deposits may grade downward into more fine-grained deposits of early Holocene to late Pleistocene age (e.g., Qo) that could preserve fossil remains at shallow or unknown depths. Quaternary young alluvial fan and fluvial deposits (Q, Qal) are assigned a low paleontological sensitivity at the surface, and a high paleontological sensitivity at depths below 5 feet.

### **Quaternary Old Alluvium**

Late to middle Pleistocene alluvium (Qo), which is mapped extensively throughout the Agua Caliente, Santa Rosa, and Sonoma Potential Sites consists of well consolidated, crudely stratified, light yellowish-brown, texturally massive to faintly laminated, poorly sorted, fine- to coarse-grained sand with sparsely distributed pebble beds (Blake et al. 2002; Wagner and Bortugno 1982). Quaternary old (early Holocene to Pleistocene) fine-grained alluvial deposits have a well-documented record of abundant and diverse vertebrate fauna recorded throughout California (Paleobiology Database 2020). Jefferson (2010) has reported numerous vertebrate fossil taxa from Sonoma County and neighboring counties including horse, tapir, bison, camelid, deer, mastodon, mammoth, ground sloth, canine, rabbit, and rodent. Late to middle Pleistocene alluvium (Qo) is assigned a high paleontological sensitivity.

### **Quaternary Old Alluvial and Marine Terrace Deposits**

Middle to early Pleistocene marine terrace deposits (Qt), mapped within a Guerneville Potential Site (GUE-1), consist of siliceous, fine-grained marine sediments and terrestrial alluvium that accumulated on a series of wave-cut platforms formed during late Pleistocene. Pleistocene terrace deposits have a record of vertebrate fossil preservation in California and have produced scientifically significant specimens from multiple localities. In coastal California, Pleistocene marine terrace deposits have yielded vertebrate fossil specimens of camel, horse, ground sloth, whale, and dolphin, shark, and fish (Jefferson 2010; Woodring et al. 1946). Middle to early Pleistocene marine terrace deposits (Qt) are assigned a high paleontological sensitivity.

### **Pleistocene Huichica and Glen Ellen Formations**

Pleistocene Huichica and Glen Ellen Formations (QT), mapped within the Glen Ellen Potential Sites, consist of brown- to buff weathering, interbedded siltstone, fine- to coarse-grained sandstone, pebbly and cobbly sandstone, conglomerate, and tuff (Blake et al. 2002; Wagner and Bortugno 1982). A review of the museum records maintained in the University of California Museum of Paleontology (UCMP) online collections database identified several fossil localities from Pleistocene Huichica and Glen Ellen formations within Sonoma County, which produced several horse teeth, freshwater molluscs, plant remains, and diatoms (UCMP locality V90056) (UCMP 2020). Pleistocene Huichica and Glen Ellen Formations (QT) are assigned a high paleontological sensitivity.

## **Pleistocene to Pliocene Petaluma Formation**

The mostly non-marine Pleistocene to Pliocene Petaluma Formation (Pp), mapped extensively within the Penngrove Potential Sites, has a maximum thickness of about 4,000 feet and consists primarily of clay, sandstone, and minor conglomerate (Blake et al. 2002; Wagner and Bortugno 1982). According to the museum records maintained in the UCMP online collections database, at least nine vertebrate localities were identified from the Petaluma Formation (UCMP 2020), which yielded fossil specimens of rabbit (Leporidae), horse (*Equus*, *Neohipparion gidleyi*), turtle (Testudines), camel (Camelidae), rhinoceros (Rhinocerotidae) within Sonoma County. Pleistocene to Pliocene Petaluma Formation (Pp) is assigned a high paleontological sensitivity.

## **Late Pliocene to late Miocene Wilson Grove Formation**

Late Pliocene to late Miocene Wilson Grove Formation (Twg, Pwg), mapped within the Graton, Forestville, and Petaluma Potential Sites, consists of fine grained, well sorted, massive to poorly bedded, light gray to light yellow-brown marine sandstone with thin lenses of pebble conglomerate. According to the museum records maintained in the UCMP online collections database, UCMP localities V81135 and V92001 produced fossil specimens of cartilaginous fish (*Cetorhinus maximus*, *Isurus oxyrinchus*, *Hexanchus griseus*) and bony fish (*Sardinops*, *Sarda*, *Merluccius*) from the Wilson Grove Formation within Sonoma County (UCMP 2020). Late Pliocene to late Miocene Wilson Grove Formation (Twg, Pwg) is assigned a high paleontological sensitivity.

## **Pliocene to Miocene Sonoma Volcanics**

Pliocene to Miocene Sonoma Volcanics (Psv, Tsb), mapped within a Petaluma Potential Site (PET-4), consists of basalt, andesite, and rhyolite lavas interbedded with debris avalanche deposits. Certain facies, such as the basaltic and andesitic lava flows are extremely unlikely to yield fossils, whereas others such as tuffs, mudflows, and lacustrine facies have yielded significant fossils within Sonoma County. Given the lithology, Pliocene to Miocene Sonoma Volcanics (Psv, Tsb) underlying PET-4 have no paleontological sensitivity since the physical parameters of their formation are not conducive to fossil preservation. Pliocene to Miocene Sonoma Volcanics (Psv, Tsb) have no paleontological sensitivity.

## **Late Eocene to Late Cretaceous Franciscan Complex**

Late Eocene to Late Cretaceous metasedimentary rocks of the Franciscan Complex (Tsb, TKfs, KJfs, KJfm), mapped within a Guerneville Potential Site (GUE-3), consist of submetamorphosed eugeosynclinal marine sedimentary and mafic igneous rocks, including dark gray to black metabasalt greenstone. Late Eocene to Late Cretaceous metasedimentary rocks from the Franciscan Complex formed from the cooling of molten rock that was subsequently metamorphosed. The high-heat and high-pressure conditions in which these rocks formed are not suitable for life or fossilization. Consequently, metasedimentary rocks from the Franciscan Complex (Tsb, TKfs, KJfs, KJfm) have no paleontological sensitivity (SVP 2020).

## **Early Cretaceous to Late Jurassic Great Valley Complex**

Early Cretaceous to Late Jurassic rocks from the Great Valley Complex (KJgvc), mapped within a Geyserville Potential Site (GEY-4), consist of conglomerate, sandstone, siltstone, and shale. Early Cretaceous to Late Jurassic rocks from the Great Valley Complex have yielded several paleontological resources throughout California (Blake et al. 2000; 2002). A search of the paleontological locality records maintained in the online Paleobiology Database indicates that Early Cretaceous to Late Jurassic rocks

from the Great Valley Complex have rendered various significant fossil specimens of extinct cephalopod (Ammonoidea), sea urchin (Echinoidea), and cartilaginous fish (Elasmobranchii) within neighboring counties (Paleobiology Database 2020). Early Cretaceous to Late Jurassic rocks from the Great Valley Complex (KJgvc) are assigned a high paleontological sensitivity.

### **Depth to Paleontologically Sensitive Units**

Quaternary young (middle to late Holocene) alluvial fan and fluvial deposits (Q, Qal) have a low paleontological sensitivity at the surface as defined by SVP (2010) standards; however, middle to late Holocene deposits may grade downward into more fine-grained, fossiliferous deposits of early Holocene to late Pleistocene age (i.e., Qo, Qt), late Pliocene to late Miocene (i.e., Twg, Pwg), or Early Cretaceous to Late Jurassic (KJgvc) at shallow or unknown depths. Accurately assessing the boundaries between younger and older units within the Potential Sites is generally not possible without site-specific stratigraphic<sup>1</sup> data, some form of radiometric dating<sup>2</sup> or fossil analysis, so conservative estimates of the depth at which paleontologically sensitive units may occur reduces potential for impacts to paleontological resources. The depths at which these units become old enough to yield fossils is highly variable, but generally does not occur at depths of less than 5 feet. Given the proximity of geologic units with high paleontological sensitivity (i.e., Qo, Qt, Twg, and KJgvc) mapped near the Geyserville, Guerneville, Larkfield, Graton, and Santa Rosa Potential Sites, early Holocene to late Pleistocene age (i.e., Qo, Qt), late Pliocene to late Miocene (i.e., Twg), and/or Early Cretaceous to Late Jurassic (KJgvc) deposits are likely present at relatively shallow (i.e., between 5 to 10 feet) depth below younger alluvial sediments (Q, Qal). As noted above, early Holocene to late Pleistocene age, late Pliocene to late Miocene, and Early Cretaceous to Late Jurassic (KJgvc) sedimentary deposits have a well-documented record of abundant and diverse vertebrate fauna throughout California (Jefferson 2010; Paleobiology Database 2020; UCMP 2020). Therefore, areas mapped as Quaternary young (middle to late Holocene) alluvial fan and fluvial deposits (Q, Qal) are assigned a high paleontological sensitivity at depths greater than 5 feet (SVP 2020).

---

<sup>1</sup> Rock layers in the geologic units below the Potential Sites.

<sup>2</sup> Technique to determine the age of the geologic units below the Potential Sites.



# Appendix NOI

---

Construction Noise Calculations and Operational Equipment Specification Sheets

Roadway Construction Noise Model (RCNM),Version 1.1

Report date: 5/6/2020  
 Case Description: Sonoma County Rezoning

---- Receptor #1 ----

Description	Land Use	Baselines (dBA)		
		Daytime	Evening	Night
Residential	Residential	80	80	80

Description	Impact Device	Usage(%)	Equipment		Receptor Distance (feet)	Estimated Shielding (dBA)
			Spec Lmax (dBA)	Actual Lmax (dBA)		
Blasting	Yes	1	94		25	0

Calculated (dBA)

Equipment	*Lmax	Leq
Blasting	100	80
Total	100	80

\*Calculated Lmax is the Loudest value.

Roadway Construction Noise Model (RCNM), Version 1.1

Report date: 5/6/2020  
 Case Description: Sonoma County Rezoning

---- Receptor #1 ----

Description	Land Use	Baselines (dBA)		
		Daytime	Evening	Night
Residential	Residential	80	80	80

Description	Impact Device	Usage(%)	Equipment		Receptor Distance (feet)	Estimated Shielding (dBA)
			Spec Lmax (dBA)	Actual Lmax (dBA)		
Blasting	Yes	1	94	94	50	0

Calculated (dBA)

Equipment	*Lmax	Leq
Blasting	94	74
Total	94	74

\*Calculated Lmax is the Loudest value.

Roadway Construction Noise Model (RCNM), Version 1.1

Report date: 5/6/2020  
 Case Description: Sonoma County Rezoning

---- Receptor #1 ----

Description	Land Use	Baselines (dBA)		
		Daytime	Evening	Night
Residential	Residential	80	80	80

Description	Impact Device	Usage(%)	Equipment		Receptor Distance (feet)	Estimated Shielding (dBA)
			Spec Lmax (dBA)	Actual Lmax (dBA)		
Hydra Break Ram	Yes	10	90	90	25	0

Calculated (dBA)

Equipment	*Lmax	Leq
Hydra Break Ram	96	86
Total	96	86

\*Calculated Lmax is the Loudest value.

Roadway Construction Noise Model (RCNM), Version 1.1

Report date: 5/6/2020  
 Case Description: Sonoma County Rezoning

---- Receptor #1 ----

Description	Land Use	Baselines (dBA)		
		Daytime	Evening	Night
Residential	Residential	80	80	80

Description	Impact Device	Usage(%)	Equipment		Receptor Distance (feet)	Estimated Shielding (dBA)
			Spec Lmax (dBA)	Actual Lmax (dBA)		
Hydra Break Ram	Yes	10	90	90	50	0

Calculated (dBA)

Equipment	*Lmax	Leq
Hydra Break Ram	90	80
Total	90	80

\*Calculated Lmax is the Loudest value.

Roadway Construction Noise Model (RCNM), Version 1.1

Report date: 5/6/2020  
 Case Description: Sonoma County Rezoning

---- Receptor #1 ----

Description	Land Use	Baselines (dBA)		
		Daytime	Evening	Night
Residential	Residential	80	80	80

Description	Impact Device	Usage(%)	Equipment			
			Spec Lmax (dBA)	Actual Lmax (dBA)	Receptor Distance (feet)	Estimated Shielding (dBA)
Excavator	No	40		80.7	50	0
Front End Loader	No	40		79.1	50	0
Dump Truck	No	40		76.5	50	0

Calculated (dBA)

Equipment	*Lmax	Leq
Excavator	80.7	76.7
Front End Loader	79.1	75.1
Dump Truck	76.5	72.5
Total	80.7	79.9

\*Calculated Lmax is the Loudest value.

Roadway Construction Noise Model (RCNM),Version 1.1

Report date: 5/6/2020  
 Case Description: Sonoma County Rezoning

---- Receptor #1 ----

Description	Land Use	Baselines (dBA)		
		Daytime	Evening	Night
Residential	Residential	80	80	80

Description	Impact Device	Usage(%)	Equipment			
			Spec Lmax (dBA)	Actual Lmax (dBA)	Receptor Distance (feet)	Estimated Shielding (dBA)
Impact Pile Driver	Yes	20		101.3	50	0

Calculated (dBA)

Equipment	*Lmax	Leq
Impact Pile Driver	101.3	94.3
Total	101.3	94.3

\*Calculated Lmax is the Loudest value.

## ELECTRICAL DATA

38HDR UNIT SIZE	V-PH-Hz	VOLTAGE RANGE*		COMPRESSOR		OUTDOOR FAN MOTOR			MIN CKT AMPS	FUSE/ HACR BKR AMPS
		Min	Max	RLA	LRA	FLA	NEC Hp	kW Out		
018	208/230-1-60	187	253	9.0	48.0	0.80	0.125	0.09	12.1	20
024	208/230-1-60	187	253	12.8	58.3	0.80	0.125	0.09	16.8	25
030	208/230-1-60	187	253	14.1	73.0	1.45	0.25	0.19	19.1	30
036	208/230-1-60	187	253	14.1	77.0	1.45	0.25	0.19	19.1	30
	208/230-3-60	187	253	9.0	71.0	1.45	0.25	0.19	12.7	20
	460-3-60	414	506	5.6	38.0	0.80	0.25	0.19	7.8	15
048	208/230-1-60	187	253	21.8	117.0	1.45	0.25	0.19	28.7	50
	208/230-3-60	187	253	13.7	83.1	1.45	0.25	0.19	18.6	30
	460-3-60	414	506	6.2	41.0	0.80	0.25	0.19	8.6	15
060	208/230-1-60	187	253	26.4	134.0	1.45	0.25	0.19	34.5	60
	208/230-3-60	187	253	16.0	110.0	1.45	0.25	0.19	21.5	35
	460-3-60	414	506	7.8	52.0	0.80	0.25	0.19	10.6	15

\* Permissible limits of the voltage range at which the unit will operate satisfactorily

FLA - Full Load Amps

HACR - Heating, Air Conditioning, Refrigeration

LRA - Locked Rotor Amps

NEC - National Electrical Code

RLA - Rated Load Amps (compressor)

NOTE: Control circuit is 24-V on all units and requires external power source. Copper wire must be used from service disconnect to unit. All motors/compressors contain internal overload protection.

38HDR

## SOUND LEVEL

Unit Size	Standard Rating (dB)	Typical Octave Band Spectrum ( dBA ) (without tone adjustment)						
		125	250	500	1000	2000	4000	8000
018	68	52.0	57.5	60.5	63.5	60.5	57.5	46.5
024	69	57.5	61.5	63.0	61.0	60.0	56.0	45.0
030	72	56.5	63.0	65.0	66.0	64.0	62.5	57.0
036	72	65.0	61.5	63.5	65.0	64.5	61.0	54.5
048	72	58.5	61.0	64.0	67.5	66.0	64.0	57.0
060	72	63.0	61.5	64.0	66.5	66.0	64.5	55.5

## CHARGING SUBCOOLING (TXV-TYPE EXPANSION DEVICE)

UNIT SIZE-VOLTAGE, SERIES	REQUIRED SUBCOOLING °F (°C)
018	12 (6.7)
024	12 (6.7)
030	12 (6.7)
036	12 (6.7)
048	12 (6.7)
060	12 (6.7)



## 20/22 kW

### GUARDIAN® SERIES Residential Standby Generators Air-Cooled Gas Engine

#### INCLUDES:

- True Power™ Electrical Technology
- Two-line multilingual digital LCD Evolution™ controller (English/Spanish/French/Portuguese)
- 200 amp service rated smart switch transfer switch available
- Electronic governor
- Standard Wi-Fi® connectivity
- System status & maintenance interval LED indicators
- Sound attenuated enclosure
- Flexible fuel line connector
- Natural gas or LP gas operation
- 5 Year limited warranty
- Listed and labeled by the Southwest Research Institute allowing installation as close as 18 in (457 mm) to a structure.\*  
\*Must be located away from doors, windows, and fresh air intakes and in accordance with local codes.  
[https://assets.swri.org/library/DirectoryOfListedProducts/ConstructionIndustry/973\\_DoC\\_204\\_13204-01-01\\_Rev9.pdf](https://assets.swri.org/library/DirectoryOfListedProducts/ConstructionIndustry/973_DoC_204_13204-01-01_Rev9.pdf)

#### Standby Power Rating

G007038-1, G007039-1, G007038-3, G007039-3 (Aluminum - Bisque) - 20 kW 60 Hz  
G007042-2, G007043-2, G007042-3, G007043-3 (Aluminum - Bisque) - 22 kW 60 Hz



Note: CETL or CUL certification only applies to unbundled units and units packaged with limited circuit switches. Units packaged with the Smart Switch are ETL or UL certified in the USA only.

## FEATURES

- **INNOVATIVE ENGINE DESIGN & RIGOROUS TESTING** are at the heart of Generac's success in providing the most reliable generators possible. Generac's G-Force engine lineup offers added peace of mind and reliability for when it's needed the most. The G-Force series engines are purpose built and designed to handle the rigors of extended run times in high temperatures and extreme operating conditions.
- **TRUE POWER™ ELECTRICAL TECHNOLOGY:** Superior harmonics and sine wave form produce less than 5% Total Harmonic Distortion for utility quality power. This allows confident operation of sensitive electronic equipment and micro-chip based appliances, such as variable speed HVAC systems.
- **TEST CRITERIA:**
  - ✓ **PROTOTYPE TESTED**                      ✓ **NEMA MG1-22 EVALUATION**
  - ✓ **SYSTEM TORSIONAL TESTED**        ✓ **MOTOR STARTING ABILITY**
- **MOBILE LINK® CONNECTIVITY:** FREE with select Guardian Series Home standby generators, Mobile Link Wi-Fi allows users to monitor generator status from anywhere in the world using a smartphone, tablet, or PC. Easily access information such as the current operating status and maintenance alerts. Users can connect an account to an authorized service dealer for fast, friendly, and proactive service. With Mobile Link, users are taken care of before the next power outage.
- **SOLID-STATE, FREQUENCY COMPENSATED VOLTAGE REGULATION:** This state-of-the-art power maximizing regulation system is standard on all Generac models. It provides optimized FAST RESPONSE to changing load conditions and MAXIMUM MOTOR STARTING CAPABILITY by electronically torque-matching the surge loads to the engine. Digital voltage regulation at ±1%.
- **SINGLE SOURCE SERVICE RESPONSE** from Generac's extensive dealer network provides parts and service know-how for the entire unit, from the engine to the smallest electronic component.
- **GENERAC TRANSFER SWITCHES:** Long life and reliability are synonymous with GENERAC POWER SYSTEMS. One reason for this confidence is that the GENERAC product line is offered with its own transfer systems and controls for total system compatibility.



\*Assembled in the USA using domestic and foreign parts.

**Engine**

- Generac G-Force design
- “Spiny-lok” cast iron cylinder walls
- Electronic ignition/spark advance
- Full pressure lubrication system
- Low oil pressure shutdown system
- High temperature shutdown

Maximizes engine “breathing” for increased fuel efficiency. Plateau honed cylinder walls and plasma moly rings help the engine run cooler, reducing oil consumption and resulting in longer engine life.

Rigid construction and added durability provide long engine life.

These features combine to assure smooth, quick starting every time.

Pressurized lubrication to all vital bearings means better performance, less maintenance, and longer engine life. Now featuring up to a 2 year/200 hour oil change interval.

Shutdown protection prevents catastrophic engine damage due to low oil.

Prevents damage due to overheating.

**Generator**

- Revolving field
- Skewed stator
- Displaced phase excitation
- Automatic voltage regulation
- UL 2200 listed

Allows for a smaller, light weight unit that operates 25% more efficiently than a revolving armature generator.

Produces a smooth output waveform for compatibility with electronic equipment.

Maximizes motor starting capability.

Regulating output voltage to  $\pm 1\%$  prevents damaging voltage spikes.

For your safety.

**Transfer Switch (if applicable)**

- Fully automatic
- NEMA 3R
- Remote mounting

Transfers vital electrical loads to the energized source of power.

Can be installed inside or outside for maximum flexibility.

Mounts near an existing distribution panel for simple, low-cost installation.

**Evolution™ Controls**

- AUTO/MANUAL/OFF illuminated buttons
- Two-line multilingual LCD display
- Sealed, raised buttons
- Utility voltage sensing
- Generator voltage sensing
- Utility interrupt delay
- Engine warm-up
- Engine cool-down
- Programmable exercise
- Smart battery charger
- Main line circuit breaker
- Electronic governor

Selects the operating mode and provides easy, at-a-glance status indication in any condition.

Provides homeowners easily visible logs of history, maintenance, and events up to 50 occurrences.

Smooth, weather-resistant user interface for programming and operations.

Constantly monitors utility voltage, setpoints 65% dropout, 80% pick-up, of standard voltage.

Constantly monitors generator voltage to verify the cleanest power delivered to the home.

Prevents nuisance start-ups of the engine, adjustable 2-1500 seconds from the factory default setting of 5 seconds by a qualified dealer.

Verifies engine is ready to assume the load, setpoint approximately 5 seconds.

Allows engine to cool prior to shutdown, setpoint approximately 1 minute.

Operates engine to prevent oil seal drying and damage between power outages by running the generator for 5 minutes every other week. Also offers a selectable setting for weekly or monthly operation providing flexibility and potentially lower fuel costs to the owner.

Delivers charge to the battery only when needed at varying rates depending on outdoor air temperature. Compatible with lead acid and AGM-style batteries.

Protects generator from overload.

Maintains constant 60 Hz frequency.

**Unit**

- SAE weather protective enclosure
- Enclosed critical grade muffler
- Small, compact, attractive

Sound attenuated enclosures ensure quiet operation and protection against mother nature, withstanding winds up to 150 mph (241 km/h). Hinged key locking roof panel for security. Lift-out front for easy access to all routine maintenance items. Electrostatically applied textured epoxy paint for added durability.

Quiet, critical grade muffler is mounted inside the unit to prevent injuries.

Makes for an easy, eye appealing installation, as close as 18 in (457 mm) away from a structure.

## 20/22 kW

**Installation System**

- 14 in (35.6 cm) flexible fuel line connector  
Listed ANSI Z21.75/CSA 6.27 outdoor appliance connector for the required connection to the gas supply piping.
- Integral sediment trap  
Meets IFGC and NFPA 54 installation requirements.

**Connectivity (Wi-Fi equipped models only)**

- Ability to view generator status  
Monitor generator with a smartphone, tablet, or computer at any time via the Mobile Link application for complete peace of mind.
- Ability to view generator Exercise/Run and Total Hours  
Review the generator's complete protection profile for exercise hours and total hours.
- Ability to view generator maintenance information  
Provides maintenance information for the specific model generator when scheduled maintenance is due.
- Monthly report with previous month's activity  
Detailed monthly reports provide historical generator information.
- Ability to view generator battery information  
Built in battery diagnostics displaying current state of the battery.
- Weather information  
Provides detailed local ambient weather conditions for generator location.

**20/22 kW**

**Generator**

Model	G007038-1, G007039-1 (20 kW)	G007042-2, G007043-2 (22 kW)	G007038-3, G007039-3 (20 kW)	G007042-3, G007043-3 (22 kW)
Rated maximum continuous power capacity (LP)	20,000 Watts*	22,000 Watts*	20,000 Watts*	22,000 Watts*
Rated maximum continuous power capacity (NG)	19,000 Watts*	19,500 Watts*	18,000 Watts*	19,500 Watts*
Rated voltage	240			
Rated maximum continuous load current – 240 volts (LP/NG)	83.3 / 75.0	91.7 / 81.3	83.3 / 75.0	91.7 / 81.3
Total Harmonic Distortion	Less than 5%			
Main line circuit breaker	90 amp	100 amp	90 amp	100 amp
Phase	1			
Number of rotor poles	2			
Rated AC frequency	60 Hz			
Power factor	1.0			
Battery requirement (not included)	12 Volts, Group 26R 540 CCA minimum or Group 35AGM 650 CCA minimum			
Unit weight (lb / kg)	448 / 203	466 / 211	436 / 198	445 / 202
Dimensions (L x W x H) in / cm	48 x 25 x 29 / 121.9 x 63.5 x 73.7			
Sound output in dB(A) at 23 ft (7 m) with generator operating at normal load**	67	67	67	67
Sound output in dB(A) at 23 ft (7 m) with generator in Quiet-Test™ low-speed exercise mode**	55	57	55	57
Exercise duration	5 min			

**Engine**

Engine type	GENERAC G-Force 1000 Series			
Number of cylinders	2			
Displacement	999 cc			
Cylinder block	Aluminum w/ cast iron sleeve			
Valve arrangement	Overhead valve			
Ignition system	Solid-state w/ magneto			
Governor system	Electronic			
Compression ratio	9.5:1			
Starter	12 VDC			
Oil capacity including filter	Approx. 1.9 qt / 1.8 L			
Operating rpm	3,600			
Fuel consumption				
Natural gas	ft <sup>3</sup> /hr (m <sup>3</sup> /hr)			
	1/2 Load	204 (5.78)	228 (6.46)	164 (4.64)
	Full Load	301 (8.52)	327 (9.26)	287 (8.13)
Liquid propane	ft <sup>3</sup> /hr (gal/hr) [L/hr]			
	1/2 Load	87 (2.37) [8.99]	92 (2.53) [9.57]	86 (2.36) [8.95]
	Full Load	130 (3.56) [13.48]	142 (3.90) [14.77]	136 (3.74) [14.15]
				142 (3.90) [14.77]

Note: **Fuel pipe must be sized for full load.** Required fuel pressure to generator fuel inlet at all load ranges - 3.5–7 in water column (0.87–1.74 kPa) for NG, 10–12 in water column (2.49–2.99 kPa) for LP gas. For BTU content, multiply ft<sup>3</sup>/hr x 2500 (LP) or ft<sup>3</sup>/hr x 1000 (NG). For Megajoule content, multiply m<sup>3</sup>/hr x 93.15 (LP) or m<sup>3</sup>/hr x 37.26 (NG).

**Controls**

Two-line plain text multilingual LCD	Simple user interface for ease of operation.
Mode buttons: AUTO	Automatic start on utility failure. Weekly, Bi-weekly, or Monthly selectable exerciser.
MANUAL	Start with starter control, unit stays on. If utility fails, transfer to load takes place.
OFF	Stops unit. Power is removed. Control and charger still operate.
Ready to Run/Maintenance messages	Standard
Engine run hours indication	Standard
Programmable start delay between 2–1500 seconds	Standard (programmable by dealer only)
Utility Voltage Loss/Return to Utility adjustable (brownout setting)	From 140–171 V / 190–216 V
Future Set Capable Exerciser/Exercise Set Error warning	Standard
Run/Alarm/Maintenance logs	50 events each
Engine start sequence	Cyclic cranking: 16 sec on, 7 rest (90 sec maximum duration).
Starter lock-out	Starter cannot re-engage until 5 sec after engine has stopped.
Smart Battery Charger	Standard
Charger Fault/Missing AC warning	Standard
Low Battery/Battery Problem Protection and Battery Condition indication	Standard
Automatic Voltage Regulation with Over and Under Voltage Protection	Standard
Under-Frequency/Overload/Stepper Overcurrent Protection	Standard
Safety Fused/Fuse Problem Protection	Standard
Automatic Low Oil Pressure/High Oil Temperature Shutdown	Standard
Overcrank/Overspeed (@ 72 Hz)/rpm Sense Loss Shutdown	Standard
High Engine Temperature Shutdown	Standard
Internal Fault/Incorrect Wiring protection	Standard
Common external fault capability	Standard
Field upgradable firmware	Standard

\*\*Sound levels are taken from the front of the generator. Sound levels taken from other sides of the generator may be higher depending on installation parameters. Rating definitions - Standby: Applicable for supplying emergency power for the duration of the utility power outage. No overload capability is available for this rating. (All ratings in accordance with BS5514, ISO3046 and DIN6271). \* Maximum kilovolt amps and current are subject to and limited by such factors as fuel BTU/megajoule content, ambient temperature, altitude, engine power and condition, etc. Maximum power decreases approximately 3.5% for each 1,000 ft (304.8 m) above sea level; and also will decrease approximately 1% for each 10 °F (6 °C) above 60 °F (16 °C).

# 20/22 kW

# Switch Options

### Service Rated Smart Switch Features

- Includes digital power management technology (DPM) standard.
- Intelligently manages up to four air conditioner loads with no additional hardware.
- Up to eight additional large (240 VAC) loads can be managed when used in conjunction with Smart Management Modules (SMMs).
- Electrically operated, mechanically-held contacts for fast, clean connections.
- Rated for all classes of load, 100% equipment rated, both inductive and resistive.
- 2-pole, 250 VAC contactors.
- Service equipment rated, dual coil design.
- Rated for both aluminum and copper conductors.
- Main contacts are silver plated or silver alloy to resist welding and sticking.
- NEMA/UL 3R aluminum outdoor enclosure allows for indoor or outdoor mounting flexibility.

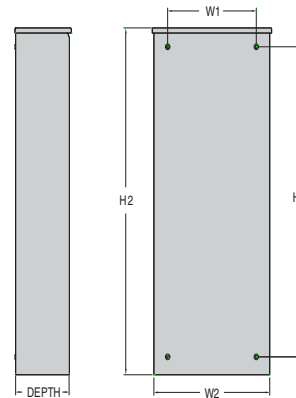
<b>Model</b>	G007039-1 (20 kW) G007043-2 (22 kW) G007039-3 (20 kW) G007043-3 (22 kW)
No. of poles	2
Current rating (amps)	200
Voltage rating (VAC)	120/240, 1Ø
Utility voltage monitor (fixed)*	
-Pick-up	80%
-Dropout	65%
Return to Utility*	Approx. 13 sec
Exercises bi-weekly for 5 minutes*	Standard
E/TL or UL listed	Standard
Enclosure type	NEMA/UL 3R
Circuit breaker protected	22,000
Lug range	250 MCM - #6

\*Function of Evolution controller  
Exercise can be set to weekly or monthly

### Dimensions

200 Amps 120/240, 1Ø Open Transition Service Rated					
	Height		Width		Depth
	H1	H2	W1	W2	
in	26.75	30.1	10.5	13.5	6.91
cm	67.95	76.45	26.67	34.29	17.55

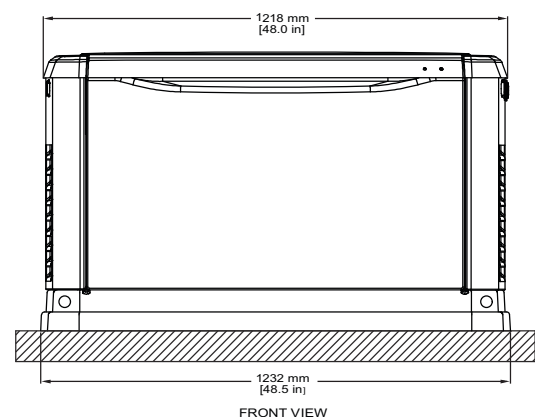
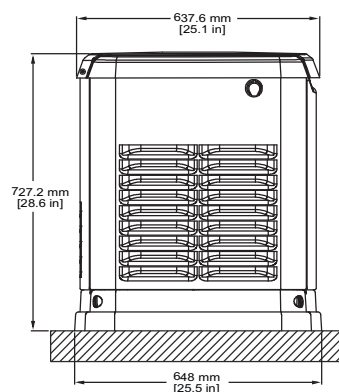
Wire Ranges		
Conductor Lug	Neutral Lug	Ground Lug
400 MCM - #4	350 MCM - #6	2/0 - #14



Model #	Product	Description
G005819-0	26R Wet Cell Battery	Every standby generator requires a battery to start the system. Generac offers the recommended 26R wet cell battery for use with all air-cooled standby product (excluding PowerPact®).
G007101-0	Battery Pad Warmer	Pad warmer rests under the battery. Recommended for use if temperature regularly falls below 0 °F (-18 °C). (Not necessary for use with AGM-style batteries).
G007102-0	Oil Warmer	Oil warmer slips directly over the oil filter. Recommended for use if temperature regularly falls below 0 °F (-18 °C).
G007103-1	Breather Warmer	Breather warmer is for use in extreme cold weather applications. For use with Evolution controllers only in climates where heavy icing occurs.
G005621-0	Auxiliary Transfer Switch Contact Kit	The auxiliary transfer switch contact kit allows the transfer switch to lock out a single large electrical load that may not be needed. Not compatible with 50 amp pre-wired switches.
G007027-0 - Bisque	Fascia Base Wrap Kit (Standard on 22 kW)	The fascia base wrap snaps together around the bottom of the new air-cooled generators. This offers a sleek, contoured appearance as well as offering protection from rodents and insects by covering the lifting holes located in the base.
G005703-0 - Bisque	Touch-Up Paint Kit	If the generator enclosure is scratched or damaged, it is important to touch up the paint to protect from future corrosion. The touch-up paint kit includes the necessary paint to correctly maintain or touch up a generator enclosure.
G006485-0	Scheduled Maintenance Kit	Generac's scheduled maintenance kit provides all the items necessary to perform complete routine maintenance on a Generac automatic standby generator (oil not included).
G007005-0	Wi-Fi LP Tank Fuel Level Monitor	The Wi-Fi enabled LP tank fuel level monitor provides constant monitoring of the connected LP fuel tank. Monitoring the LP tank's fuel level is an important step in verifying the generator is ready to run during an unexpected power failure. Status alerts are available through a free application to notify users when the LP tank is in need of a refill.
G007000-0 (50 amp) G007006-0 (100 amp)	Smart Management Module	Smart Management Modules (SMM) are used to optimize the performance of a standby generator. It manages large electrical loads upon startup and sheds them to aid in recovery when overloaded. In many cases, using SMM's can reduce the overall size and cost of the system.
G007169-0	Mobile Link® Cellular Accessories	The Mobile Link family of Cellular Accessories allows users to monitor generator status from anywhere in the world, using a smart phone, tablet, or PC. Easily access information such as the current operating status and maintenance alerts. Users can connect an account with an authorized service dealer for fast, friendly, and proactive service. With Mobile Link, users are taken care of before the next power outage.

## Dimensions & UPCs

Model	UPC
G007038-1	696471074185
G007038-3	696471074185
G007039-1	696471074192
G007039-3	696471074192
G007042-2	696471074208
G007042-3	696471074208
G007043-2	696471074215
G007043-3	696471074215



Dimensions shown are approximate. See installation manual for exact dimensions. DO NOT USE THESE DIMENSIONS FOR INSTALLATION PURPOSES.

# Appendix NOP

---

Notice of Preparation

**Sonoma County Housing Element Update EIR  
Notice of Preparation (NOP) and Scoping Comments**

The County of Sonoma distributed an NOP of the Program EIR for a 30-day agency and public review period (June 15, 2022 to July 15, 2022). In addition, the County held a virtual Scoping Meeting on June 28, 2022. The comments contained herein were submitted to the County during the NOP comment period for consideration in preparation of the DEIR.





## NOTICE OF PREPARATION OF PROGRAM EIR AND NOTICE OF PROGRAM EIR PUBLIC SCOPING MEETING

### Sonoma County Housing Element Update Program EIR

**Date:** June 15, 2022

**To:** State Clearinghouse, Responsible and Trustee Agencies, and Interested Parties and Organizations

**Project Title:** Sonoma County Housing Element Update

**Comment Period:** June 15, 2022 through July 15, 2022

**Scoping Meeting:** VIRTUAL, Tuesday, June 28, 2022, at 6:00 p.m. PST

**Lead Agency:** County of Sonoma

**Project Location:** Countywide (refer to Figure 1)

**Lead Agency Contact:** Eric Gage, Planner III  
County of Sonoma  
2550 Ventura Avenue  
Santa Rosa, California 95403  
[PermitSonoma-Housing@sonoma-county.org](mailto:PermitSonoma-Housing@sonoma-county.org)

The Sonoma County Permit and Resource Management Department (Permit Sonoma) is preparing an update to the Housing Element of the Sonoma County General Plan 2020 and has determined that a Program Environmental Impact Report (EIR) will be necessary to evaluate environmental impacts of the Housing Element Update. The County requests comments and guidance on the scope and content of the Program EIR from responsible and trustee agencies, interested public agencies, organizations, and the general public in compliance with the California Environmental Quality Act (CEQA; California Public Resources Code, Section 21000 et seq.), and California Code of Regulations, Title 14, Division 6, Chapter 3 (State CEQA Guidelines). The County prepared this Notice of Preparation (NOP) in accordance with CEQA Guidelines Sections 15082(a) and 15375.

This notice provides a summary of the Housing Element Update project; includes the County's preliminary identification of the potential environmental issues to be analyzed in the EIR; and provides information on how to comment on the scope of the EIR and how to participate in the Public Scoping Meeting.



**NOTICE OF PREPARATION OF A DRAFT ENVIRONMENTAL IMPACT REPORT  
SONOMA COUNTY HOUSING ELEMENT UPDATE**

The County invites any and all input and comments regarding the preparation of the Program EIR. If applicable, please indicate a contact person for your agency or organization. If your agency is a responsible agency as defined by CEQA Guidelines Section 15381, your agency may use the environmental documents prepared by the County when considering permits or approvals for action regarding the project.

**Public Scoping Meeting:**

The County will hold a virtual scoping meeting to provide an opportunity for agency staff and interested members of the public to submit verbal comments on the scope of the environmental issues to be addressed in the EIR. The virtual scoping meeting will be held on **Tuesday, June 28, 2022, at 6:00 p.m.**

**PST.** To join the meeting by computer or provide comment by phone, use the Zoom link or phone number on the Housing Element webpage:

<https://permitsonoma.org/regulationsandinitiatives/housing/housingelement#events>.

The scoping meeting will begin with a presentation followed by a question and answer session.

The scoping presentation will be recorded and available to view after June 30, 2022 on: <https://www.youtube.com/c/PermitSonoma/videos>.

If you have questions regarding this NOP or the scoping meeting, please contact Eric Gage at 707-565-1391 or via email at [PermitSonoma-Housing@sonoma-county.org](mailto:PermitSonoma-Housing@sonoma-county.org).

**Written Comments:** Please submit written comments within 30 days of the date of this notice by 5:00 p.m. on July 15, 2022, via email to [PermitSonoma-Housing@sonoma-county.org](mailto:PermitSonoma-Housing@sonoma-county.org) or by regular mail to Permit Sonoma, Attn: Eric Gage, 2550 Ventura Avenue, Santa Rosa, California 95403.

**Proposed Project:**

The Sonoma County Permit and Resource Management Department (Permit Sonoma) is preparing its 6<sup>th</sup> Cycle Housing Element Update, which will result in a series of zoning changes and a General Plan Amendment necessary to accommodate the County's Regional Housing Needs Allocation (RHNA). The RHNA is the number of dwelling units assigned to each jurisdiction by state and regional agencies that each city and county must plan for. The County is not responsible to construct the housing, but must identify and zone sites that can accommodate the assigned number of units for the duration of the 8-year Housing Element Cycle. For the current 5<sup>th</sup> RHNA cycle ending in 2022, the County was allocated a total of 515 units to be accommodated in its Housing Element inventory of adequate sites. The County's 6<sup>th</sup> Cycle RHNA is 3,881 dwelling units.

The Housing Element update presents a comprehensive set of housing policies and actions for the years 2023-2031 and will encompass all of unincorporated Sonoma County. The Housing Element update will be based on the County's final RHNA, which determined that the County needs to identify and zone sites for approximately 3,881 residential units, plus a buffer of some number of units to ensure ongoing compliance with the No Net Loss provisions of State housing law. The County expects to exceed the growth forecasts in General Plan 2020. Due to the anticipated increase in residents beyond current forecasts, the County has determined that a Program EIR will be the best document to comply with CEQA.

In order to accommodate as many as 3,881 new units, Sonoma County may be required to find additional sites – some in areas not previously targeted as inventory sites – as well as rezone other areas. The County



**Sonoma County Permit and Resource Management Department**  
2550 Ventura Avenue Santa Rosa CA 95403-2859 (707) 565-1900  
[www.PermitsSonoma.org](http://www.PermitsSonoma.org)



anticipates a rezoning effort targeted in designated Urban Service Areas throughout unincorporated Sonoma County and the environmental analysis will also include the proposed rezoning effort.

**Project Background:** The County of Sonoma is updating its housing element as required by State law. This process is an opportunity for the County to examine all the policies, market conditions, and other forces that contribute to an adequate supply of housing homes for everyone in the community, regardless of income.

Under California law, the housing element is one of the seven mandated elements of the general plan and must be updated on a set schedule. A housing element is required by State law (“Housing Element law”) to establish policies and programs that will support the provision of an adequate housing supply for citizens of all income levels.

The housing element typically includes:

1. **Housing Needs Assessment:** Examine demographic, employment, and housing trends and conditions that affect the housing needs of the community.
2. **Evaluation of Past Performance:** Review the prior housing element to measure progress in implementing policies and programs.
3. **Housing Sites Inventory:** Identify locations of available sites for housing development or redevelopment to ensure that there is adequate capacity to address the Regional Housing Needs Allocation.
4. **Community Outreach and Engagement:** Implement a robust community outreach and engagement program, with a particular focus on outreach to traditionally underrepresented groups.
5. **Constraints Analysis:** Analyze and recommend remedies for existing and potential governmental and nongovernmental barriers to housing development.
6. **Policies and Programs:** Establish policies and programs to fulfill the identified housing needs.

In 2020, Permit Sonoma initiated the Rezoning Sites for Housing Project, and it circulated a Draft EIR for the project in May 2021 (SCH No. 2020030351). However, following circulation of that Draft EIR, Permit Sonoma determined that due to the imminent Housing Element Update it would not move forward with rezoning the 59 sites identified as a part of this effort as a separate project and instead would incorporate rezoning of these sites as one component of the broader Housing Element update. Accordingly, the Board of Supervisors did not certify the Rezoning Sites for Housing Project Draft EIR. Just as the Housing Element Update is a different project from the Rezoning Sites project, the EIR for the Housing Element Update will be a new and distinct document. To that end, the Housing Element Update EIR will incorporate some information from the Rezoning Sites Draft EIR, as appropriate, but it will be a new and distinct document that analyzes the environmental effects of the comprehensive Housing Element Update throughout the County.

**Project Location:** Housing Element policies and programs will apply countywide, and the County boundaries are shown in Figure 1.



**Project Alternatives:** The EIR will evaluate a reasonable range of project alternatives that, consistent with CEQA, meet most of the project objectives and reduce or avoid potential environmental effects, including a required No Project Alternative.

**Next Steps:** The County will issue a Notice of Availability of a Draft EIR at that time to inform the public and interested agencies, groups, and individuals of how to access the Draft EIR and provide comments.

When the Draft EIR is completed, it will be available for review at Permit Sonoma, located at 2550 Ventura Avenue, Santa Rosa, California 95403 and online at:  
<https://permitsonoma.org/regulationsandinitiatives/housing/housingelement>.

***Potential Environmental Effects:***

The EIR will describe the reasonably foreseeable and potentially significant adverse effects of the proposed project (both direct and indirect). The EIR also will evaluate the cumulative impacts of the project when considered in conjunction with other related past, present, and reasonably foreseeable future projects. The County anticipates that the proposed project could result in potentially significant environmental impacts in the following topic areas, which will be further evaluated in the EIR.

- |                                 |                                |
|---------------------------------|--------------------------------|
| Aesthetics/Visual               | Noise                          |
| Air Quality                     | Population and Housing         |
| Biological Resources            | Public Services and Recreation |
| Cultural Resources              | Transportation                 |
| Energy                          | Tribal Cultural Resources      |
| Geology and Soils               | Utilities and Service Systems  |
| Greenhouse Gas Emissions        | Wildfire                       |
| Hazards and Hazardous Materials | Cumulative Effects             |
| Hydrology and Water Quality     | Growth Inducing Effects        |
| Land Use and Planning           |                                |

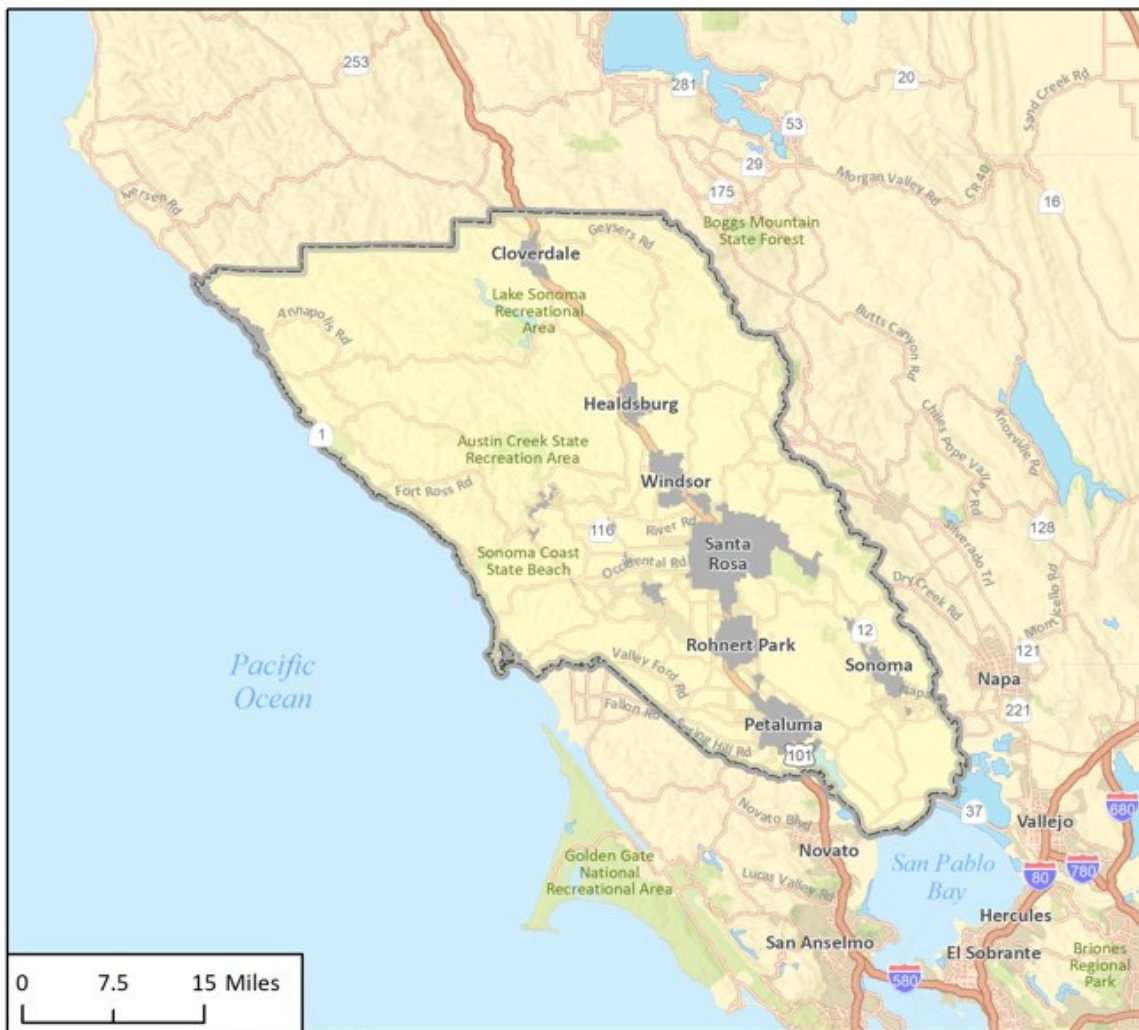
---

Eric Gage, Planner III




---

Date

Figure 1



Basemap provided by Esri and its licensors © 2022.

-  Project Location
  -  Sonoma County
  -  Incorporated Cities
- N

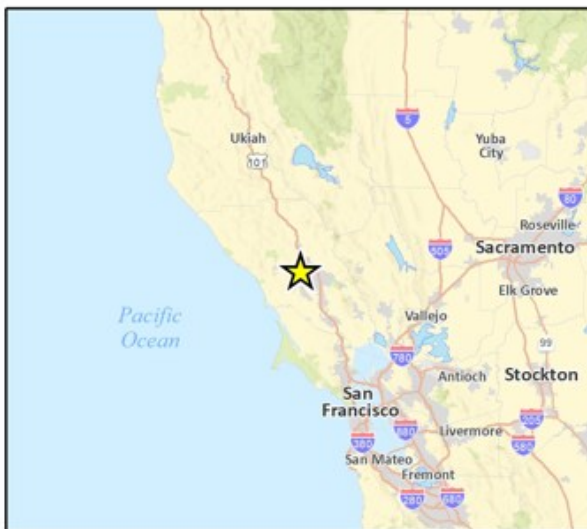


Fig. 1 Regional Location

## California Department of Transportation

DISTRICT 4  
OFFICE OF TRANSIT AND COMMUNITY PLANNING  
P.O. BOX 23660, MS-10D | OAKLAND, CA 94623-0660  
[www.dot.ca.gov](http://www.dot.ca.gov)



July 26, 2022

SCH #: 2022060323  
GTS #: 04-SON-2022-00683  
GTS ID: 26749  
Co/Rt/Pm: SON/VAR/VAR

Eric Gage, Planner III  
County of Sonoma  
2550 Ventura Avenue  
Santa Rosa, CA 95403

### **Re: Sonoma County Housing Element Update Notice of Preparation (NOP) for Draft Environmental Impact Report (DEIR)**

Dear Eric Gage:

Thank you for including the California Department of Transportation (Caltrans) in the environmental review process for the Sonoma County Housing Element Update Project. We are committed to ensuring that impacts to the State's multimodal transportation system and to our natural environment are identified and mitigated to support a safe, sustainable, integrated and efficient transportation system. The following comments are based on our review of the June 2022 NOP.

#### **Project Understanding**

The Sonoma County Permit and Resource Management Department (Permit Sonoma) is preparing its 6th Cycle Housing Element Update, which will result in a series of zoning changes and a General Plan Amendment necessary to accommodate the County's Regional Housing Needs Allocation (RHNA). The RHNA is the number of dwelling units assigned to each jurisdiction by state and regional agencies that each city and county must plan for. The County is not responsible to construct the housing but must identify and zone sites that can accommodate the assigned number of units for the duration of the 8-year Housing Element Cycle. For the current 5th RHNA cycle ending in 2022, the County was allocated a total of 515 units to be accommodated in its Housing Element inventory of adequate sites. The County's 6th Cycle RHNA is 3,881 dwelling units.

#### **Travel Demand Analysis**

With the enactment of Senate Bill (SB) 743, Caltrans is focused on maximizing efficient development patterns, innovative travel demand reduction strategies, and

multimodal improvements. For more information on how Caltrans assesses Transportation Impact Studies, please review Caltrans' Transportation Impact Study Guide ([link](#)). Please note that current and future land use projects proposed near and adjacent to the State Transportation Network (STN) may be assessed, in part, through the TISG.

### **Transportation Impact Fees**

We encourage a sufficient allocation of fair share contributions toward multi-modal and regional transit improvements to fully mitigate cumulative impacts to regional transportation. We also strongly support measures to increase sustainable mode shares, thereby reducing VMT. Caltrans welcomes the opportunity to work with the City and local partners to secure the funding for needed mitigation. Traffic mitigation or cooperative agreements are examples of such measures.

### **Lead Agency**

As the Lead Agency, the County of Sonoma is responsible for all project mitigation, including any needed improvements to the STN. The project's fair share contribution, financing, scheduling, implementation responsibilities and lead agency monitoring should be fully discussed for all proposed mitigation measures.

### **Equitable Access**

If any Caltrans facilities are impacted by the project, those facilities must meet American Disabilities Act (ADA) Standards after project completion. As well, the project must maintain bicycle and pedestrian access during construction. These access considerations support Caltrans' equity mission to provide a safe, sustainable, and equitable transportation network for all users.

Thank you again for including Caltrans in the environmental review process. Should you have any questions regarding this letter, or for future notifications and requests for review of new projects, please email [LDR-D4@dot.ca.gov](mailto:LDR-D4@dot.ca.gov).

Sincerely,



MARK LEONG  
District Branch Chief  
Local Development Review

c: State Clearinghouse



## NATIVE AMERICAN HERITAGE COMMISSION

June 16, 2022

Eric Gage  
County of Sonoma  
2550 Ventura Avenue  
Santa Rosa, CA 95403

**Re: 2022060323, Housing Element Update Project, Sonoma County**

Dear Mr. Gage:

The Native American Heritage Commission (NAHC) has received the Notice of Preparation (NOP), Draft Environmental Impact Report (DEIR) or Early Consultation for the project referenced above. The California Environmental Quality Act (CEQA) (Pub. Resources Code §21000 et seq.), specifically Public Resources Code §21084.1, states that a project that may cause a substantial adverse change in the significance of a historical resource, is a project that may have a significant effect on the environment. (Pub. Resources Code § 21084.1; Cal. Code Regs., tit.14, §15064.5 (b) (CEQA Guidelines §15064.5 (b)). If there is substantial evidence, in light of the whole record before a lead agency, that a project may have a significant effect on the environment, an Environmental Impact Report (EIR) shall be prepared. (Pub. Resources Code §21080 (d); Cal. Code Regs., tit. 14, § 5064 subd.(a)(1) (CEQA Guidelines §15064 (a)(1)). In order to determine whether a project will cause a substantial adverse change in the significance of a historical resource, a lead agency will need to determine whether there are historical resources within the area of potential effect (APE).

CEQA was amended significantly in 2014. Assembly Bill 52 (Gatto, Chapter 532, Statutes of 2014) (AB 52) amended CEQA to create a separate category of cultural resources, "tribal cultural resources" (Pub. Resources Code §21074) and provides that a project with an effect that may cause a substantial adverse change in the significance of a tribal cultural resource is a project that may have a significant effect on the environment. (Pub. Resources Code §21084.2). Public agencies shall, when feasible, avoid damaging effects to any tribal cultural resource. (Pub. Resources Code §21084.3 (a)). **AB 52 applies to any project for which a notice of preparation, a notice of negative declaration, or a mitigated negative declaration is filed on or after July 1, 2015.** If your project involves the adoption of or amendment to a general plan or a specific plan, or the designation or proposed designation of open space, on or after March 1, 2005, it may also be subject to Senate Bill 18 (Burton, Chapter 905, Statutes of 2004) (SB 18). **Both SB 18 and AB 52 have tribal consultation requirements.** If your project is also subject to the federal National Environmental Policy Act (42 U.S.C. § 4321 et seq.) (NEPA), the tribal consultation requirements of Section 106 of the National Historic Preservation Act of 1966 (154 U.S.C. 300101, 36 C.F.R. §800 et seq.) may also apply.

The NAHC recommends consultation with California Native American tribes that are traditionally and culturally affiliated with the geographic area of your proposed project as early as possible in order to avoid inadvertent discoveries of Native American human remains and best protect tribal cultural resources. Below is a brief summary of portions of AB 52 and SB 18 as well as the NAHC's recommendations for conducting cultural resources assessments.

**Consult your legal counsel about compliance with AB 52 and SB 18 as well as compliance with any other applicable laws.**[AB 52](#)

CHAIRPERSON  
**Laura Miranda**  
Luiseño

VICE CHAIRPERSON  
**Reginald Pagaling**  
Chumash

PARLIAMENTARIAN  
**Russell Attebery**  
Karuk

SECRETARY  
**Sara Dutschke**  
Miwok

COMMISSIONER  
**William Mungary**  
Paiute/White Mountain  
Apache

COMMISSIONER  
**Isaac Bojorquez**  
Ohlone-Costanoan

COMMISSIONER  
**Buffy McQuillen**  
Yokayo Pomo, Yuki,  
Nomlaki

COMMISSIONER  
**Wayne Nelson**  
Luiseño

COMMISSIONER  
**Stanley Rodriguez**  
Kumeyaay

EXECUTIVE SECRETARY  
**Raymond C.  
Hitchcock**  
Miwok/Nisenan

**NAHC HEADQUARTERS**  
1550 Harbor Boulevard  
Suite 100  
West Sacramento,  
California 95691  
(916) 373-3710  
[nahc@nahc.ca.gov](mailto:nahc@nahc.ca.gov)  
[NAHC.ca.gov](http://NAHC.ca.gov)



AB 52 has added to CEQA the additional requirements listed below, along with many other requirements:

- 1. Fourteen Day Period to Provide Notice of Completion of an Application/Decision to Undertake a Project:** Within fourteen (14) days of determining that an application for a project is complete or of a decision by a public agency to undertake a project, a lead agency shall provide formal notification to a designated contact of, or tribal representative of, traditionally and culturally affiliated California Native American tribes that have requested notice, to be accomplished by at least one written notice that includes:

  - a. A brief description of the project.
  - b. The lead agency contact information.
  - c. Notification that the California Native American tribe has 30 days to request consultation. (Pub. Resources Code §21080.3.1 (d)).
  - d. A "California Native American tribe" is defined as a Native American tribe located in California that is on the contact list maintained by the NAHC for the purposes of Chapter 905 of Statutes of 2004 (SB 18). (Pub. Resources Code §21073).
- 2. Begin Consultation Within 30 Days of Receiving a Tribe's Request for Consultation and Before Releasing a Negative Declaration, Mitigated Negative Declaration, or Environmental Impact Report:** A lead agency shall begin the consultation process within 30 days of receiving a request for consultation from a California Native American tribe that is traditionally and culturally affiliated with the geographic area of the proposed project. (Pub. Resources Code §21080.3.1, subds. (d) and (e)) and prior to the release of a negative declaration, mitigated negative declaration or Environmental Impact Report. (Pub. Resources Code §21080.3.1(b)).

  - a. For purposes of AB 52, "consultation shall have the same meaning as provided in Gov. Code §65352.4 (SB 18). (Pub. Resources Code §21080.3.1 (b)).
- 3. Mandatory Topics of Consultation If Requested by a Tribe:** The following topics of consultation, if a tribe requests to discuss them, are mandatory topics of consultation:

  - a. Alternatives to the project.
  - b. Recommended mitigation measures.
  - c. Significant effects. (Pub. Resources Code §21080.3.2 (a)).
- 4. Discretionary Topics of Consultation:** The following topics are discretionary topics of consultation:

  - a. Type of environmental review necessary.
  - b. Significance of the tribal cultural resources.
  - c. Significance of the project's impacts on tribal cultural resources.
  - d. If necessary, project alternatives or appropriate measures for preservation or mitigation that the tribe may recommend to the lead agency. (Pub. Resources Code §21080.3.2 (a)).
- 5. Confidentiality of Information Submitted by a Tribe During the Environmental Review Process:** With some exceptions, any information, including but not limited to, the location, description, and use of tribal cultural resources submitted by a California Native American tribe during the environmental review process shall not be included in the environmental document or otherwise disclosed by the lead agency or any other public agency to the public, consistent with Government Code §6254 (r) and §6254.10. Any information submitted by a California Native American tribe during the consultation or environmental review process shall be published in a confidential appendix to the environmental document unless the tribe that provided the information consents, in writing, to the disclosure of some or all of the information to the public. (Pub. Resources Code §21082.3 (c)(1)).
- 6. Discussion of Impacts to Tribal Cultural Resources in the Environmental Document:** If a project may have a significant impact on a tribal cultural resource, the lead agency's environmental document shall discuss both of the following:

  - a. Whether the proposed project has a significant impact on an identified tribal cultural resource.
  - b. Whether feasible alternatives or mitigation measures, including those measures that may be agreed to pursuant to Public Resources Code §21082.3, subdivision (a), avoid or substantially lessen the impact on the identified tribal cultural resource. (Pub. Resources Code §21082.3 (b)).

- 7. Conclusion of Consultation:** Consultation with a tribe shall be considered concluded when either of the following occurs:
- a.** The parties agree to measures to mitigate or avoid a significant effect, if a significant effect exists, on a tribal cultural resource; or
  - b.** A party, acting in good faith and after reasonable effort, concludes that mutual agreement cannot be reached. (Pub. Resources Code §21080.3.2 (b)).
- 8. Recommending Mitigation Measures Agreed Upon in Consultation in the Environmental Document:** Any mitigation measures agreed upon in the consultation conducted pursuant to Public Resources Code §21080.3.2 shall be recommended for inclusion in the environmental document and in an adopted mitigation monitoring and reporting program, if determined to avoid or lessen the impact pursuant to Public Resources Code §21082.3, subdivision (b), paragraph 2, and shall be fully enforceable. (Pub. Resources Code §21082.3 (a)).
- 9. Required Consideration of Feasible Mitigation:** If mitigation measures recommended by the staff of the lead agency as a result of the consultation process are not included in the environmental document or if there are no agreed upon mitigation measures at the conclusion of consultation, or if consultation does not occur, and if substantial evidence demonstrates that a project will cause a significant effect to a tribal cultural resource, the lead agency shall consider feasible mitigation pursuant to Public Resources Code §21084.3 (b). (Pub. Resources Code §21082.3 (e)).
- 10. Examples of Mitigation Measures That, If Feasible, May Be Considered to Avoid or Minimize Significant Adverse Impacts to Tribal Cultural Resources:**
- a.** Avoidance and preservation of the resources in place, including, but not limited to:
    - i.** Planning and construction to avoid the resources and protect the cultural and natural context.
    - ii.** Planning greenspace, parks, or other open space, to incorporate the resources with culturally appropriate protection and management criteria.
  - b.** Treating the resource with culturally appropriate dignity, taking into account the tribal cultural values and meaning of the resource, including, but not limited to, the following:
    - i.** Protecting the cultural character and integrity of the resource.
    - ii.** Protecting the traditional use of the resource.
    - iii.** Protecting the confidentiality of the resource.
  - c.** Permanent conservation easements or other interests in real property, with culturally appropriate management criteria for the purposes of preserving or utilizing the resources or places.
  - d.** Protecting the resource. (Pub. Resource Code §21084.3 (b)).
  - e.** Please note that a federally recognized California Native American tribe or a non-federally recognized California Native American tribe that is on the contact list maintained by the NAHC to protect a California prehistoric, archaeological, cultural, spiritual, or ceremonial place may acquire and hold conservation easements if the conservation easement is voluntarily conveyed. (Civ. Code §815.3 (c)).
  - f.** Please note that it is the policy of the state that Native American remains and associated grave artifacts shall be repatriated. (Pub. Resources Code §5097.991).
- 11. Prerequisites for Certifying an Environmental Impact Report or Adopting a Mitigated Negative Declaration or Negative Declaration with a Significant Impact on an Identified Tribal Cultural Resource:** An Environmental Impact Report may not be certified, nor may a mitigated negative declaration or a negative declaration be adopted unless one of the following occurs:
- a.** The consultation process between the tribes and the lead agency has occurred as provided in Public Resources Code §21080.3.1 and §21080.3.2 and concluded pursuant to Public Resources Code §21080.3.2.
  - b.** The tribe that requested consultation failed to provide comments to the lead agency or otherwise failed to engage in the consultation process.
  - c.** The lead agency provided notice of the project to the tribe in compliance with Public Resources Code §21080.3.1 (d) and the tribe failed to request consultation within 30 days. (Pub. Resources Code §21082.3 (d)).

The NAHC's PowerPoint presentation titled, "Tribal Consultation Under AB 52: Requirements and Best Practices" may be found online at: [http://nahc.ca.gov/wp-content/uploads/2015/10/AB52TribalConsultation\\_CalEPAPDF.pdf](http://nahc.ca.gov/wp-content/uploads/2015/10/AB52TribalConsultation_CalEPAPDF.pdf)

## SB 18

SB 18 applies to local governments and requires local governments to contact, provide notice to, refer plans to, and consult with tribes prior to the adoption or amendment of a general plan or a specific plan, or the designation of open space. (Gov. Code §65352.3). Local governments should consult the Governor's Office of Planning and Research's "Tribal Consultation Guidelines," which can be found online at: [https://www.opr.ca.gov/docs/09\\_14\\_05\\_Updated\\_Guidelines\\_922.pdf](https://www.opr.ca.gov/docs/09_14_05_Updated_Guidelines_922.pdf).

Some of SB 18's provisions include:

1. **Tribal Consultation:** If a local government considers a proposal to adopt or amend a general plan or a specific plan, or to designate open space it is required to contact the appropriate tribes identified by the NAHC by requesting a "Tribal Consultation List." If a tribe, once contacted, requests consultation the local government must consult with the tribe on the plan proposal. **A tribe has 90 days from the date of receipt of notification to request consultation unless a shorter timeframe has been agreed to by the tribe.** (Gov. Code §65352.3 (a)(2)).
2. **No Statutory Time Limit on SB 18 Tribal Consultation.** There is no statutory time limit on SB 18 tribal consultation.
3. **Confidentiality:** Consistent with the guidelines developed and adopted by the Office of Planning and Research pursuant to Gov. Code §65040.2, the city or county shall protect the confidentiality of the information concerning the specific identity, location, character, and use of places, features and objects described in Public Resources Code §5097.9 and §5097.993 that are within the city's or county's jurisdiction. (Gov. Code §65352.3 (b)).
4. **Conclusion of SB 18 Tribal Consultation:** Consultation should be concluded at the point in which:
  - a. The parties to the consultation come to a mutual agreement concerning the appropriate measures for preservation or mitigation; or
  - b. Either the local government or the tribe, acting in good faith and after reasonable effort, concludes that mutual agreement cannot be reached concerning the appropriate measures of preservation or mitigation. (Tribal Consultation Guidelines, Governor's Office of Planning and Research (2005) at p. 18).

Agencies should be aware that neither AB 52 nor SB 18 precludes agencies from initiating tribal consultation with tribes that are traditionally and culturally affiliated with their jurisdictions before the timeframes provided in AB 52 and SB 18. For that reason, we urge you to continue to request Native American Tribal Contact Lists and "Sacred Lands File" searches from the NAHC. The request forms can be found online at: <http://nahc.ca.gov/resources/forms/>.

### NAHC Recommendations for Cultural Resources Assessments

To adequately assess the existence and significance of tribal cultural resources and plan for avoidance, preservation in place, or barring both, mitigation of project-related impacts to tribal cultural resources, the NAHC recommends the following actions:

1. Contact the appropriate regional California Historical Research Information System (CHRIS) Center ([https://ohp.parks.ca.gov/?page\\_id=30331](https://ohp.parks.ca.gov/?page_id=30331)) for an archaeological records search. The records search will determine:
  - a. If part or all of the APE has been previously surveyed for cultural resources.
  - b. If any known cultural resources have already been recorded on or adjacent to the APE.
  - c. If the probability is low, moderate, or high that cultural resources are located in the APE.
  - d. If a survey is required to determine whether previously unrecorded cultural resources are present.
2. If an archaeological inventory survey is required, the final stage is the preparation of a professional report detailing the findings and recommendations of the records search and field survey.
  - a. The final report containing site forms, site significance, and mitigation measures should be submitted immediately to the planning department. All information regarding site locations, Native American human remains, and associated funerary objects should be in a separate confidential addendum and not be made available for public disclosure.
  - b. The final written report should be submitted within 3 months after work has been completed to the appropriate regional CHRIS center.

3. Contact the NAHC for:
  - a. A Sacred Lands File search. Remember that tribes do not always record their sacred sites in the Sacred Lands File, nor are they required to do so. A Sacred Lands File search is not a substitute for consultation with tribes that are traditionally and culturally affiliated with the geographic area of the project's APE.
  - b. A Native American Tribal Consultation List of appropriate tribes for consultation concerning the project site and to assist in planning for avoidance, preservation in place, or, failing both, mitigation measures.
  
4. Remember that the lack of surface evidence of archaeological resources (including tribal cultural resources) does not preclude their subsurface existence.
  - a. Lead agencies should include in their mitigation and monitoring reporting program plan provisions for the identification and evaluation of inadvertently discovered archaeological resources per Cal. Code Regs., tit. 14, §15064.5(f) (CEQA Guidelines §15064.5(f)). In areas of identified archaeological sensitivity, a certified archaeologist and a culturally affiliated Native American with knowledge of cultural resources should monitor all ground-disturbing activities.
  - b. Lead agencies should include in their mitigation and monitoring reporting program plans provisions for the disposition of recovered cultural items that are not burial associated in consultation with culturally affiliated Native Americans.
  - c. Lead agencies should include in their mitigation and monitoring reporting program plans provisions for the treatment and disposition of inadvertently discovered Native American human remains. Health and Safety Code §7050.5, Public Resources Code §5097.98, and Cal. Code Regs., tit. 14, §15064.5, subdivisions (d) and (e) (CEQA Guidelines §15064.5, subds. (d) and (e)) address the processes to be followed in the event of an inadvertent discovery of any Native American human remains and associated grave goods in a location other than a dedicated cemetery.

If you have any questions or need additional information, please contact me at my email address:  
[Cameron.Vela@nahc.ca.gov](mailto:Cameron.Vela@nahc.ca.gov).

Sincerely,

*Cameron Vela*

Cameron Vela  
Cultural Resources Analyst

cc: State Clearinghouse

---

**From:** Eric Gage <Eric.Gage@sonoma-county.org>  
**Sent:** Thursday, June 30, 2022 9:58 AM  
**To:** Eric Gage  
**Subject:** Rick Coates - HE Scoping

-----Original Message-----

From: Rick Coates <rcoates@sonic.net>  
Sent: Tuesday, June 28, 2022 2:56 PM  
To: PermitSonoma-Housing <PermitSonoma-Housing@sonoma-county.org>  
Subject: Scoping for Housing Element of GP

EXTERNAL

The EIR for the Housing Element of the General Plan should evaluate the following:

The comparative advantages of building housing near train stations versus bus stops. Specifically the comparative likelihood that residents will use transit.

The projected effect on VMT. Will it decrease VMT as required?

The projected effect on GHG emissions. This includes travel emissions and construction emissions.

Evaluate the fire potential of any location selected in light of major fire history.

Rick Coates  
707-632-6070 or rcoates@sonic.net

THIS EMAIL ORIGINATED OUTSIDE OF THE SONOMA COUNTY EMAIL SYSTEM.

Warning: If you don't know this email sender or the email is unexpected, do not click any web links, attachments, and never give out your user ID or password.

# Appendix NRG

---

Energy Calculation Sheets

# Rezoning Sites for Housing

Last Updated: October 26, 2020

Compression-Ignition Engine Brake-Specific Fuel Consumption (BSFC) Factors [1]:

HP: 0 to 100	0.0588	HP: Greater than 100	0.0529
--------------	--------	----------------------	--------

*Values above are expressed in gallons per horsepower-hour/BSFC.*

CONSTRUCTION EQUIPMENT						
Construction Equipment	#	Hours per Day	Horsepower	Load Factor	Construction Phase	Fuel Used (gallons)
Concrete/Industrial Saws	1	8	81	0.73	Demo	4,169.67
Excavators	3	8	158	0.38	Demo	11,425.15
Rubber Tired Dozer	2	8	247	0.40	Demo	12,533.92
Rubber Tired Dozer	3	8	247	0.40	Site Prep	18,800.89
Tractors/Loaders/Backhoes	4	8	97	0.37	Site Prep	10,123.43
Excavators	2	8	158	0.38	Grading	22,850.31
Graders	1	8	187	0.41	Grading	14,589.72
Rubber Tired Dozer	1	8	247	0.40	Grading	18,800.89
Scrapers	2	8	367	0.48	Grading	67,043.81
Tractors/Loaders/Backhoes	2	8	97	0.37	Grading	15,185.15
Cranes	1	7	231	0.29	Building	24,787.17
Forklifts	3	8	89	0.20	Building	25,104.08
Generator Sets	1	8	84	0.74	Building	29,222.27
Tractors/Loaders/Backhoes	3	7	97	0.37	Building	44,290.01
Welders	1	8	46	0.45	Building	9,731.36
Air Compressors	1	6	78	0.48	Arch Coating	3,960.24
Pavers	2	8	130	0.42	Paving	13,853.29
Paving Equipment	2	8	132	0.36	Paving	12,056.93
Rollers	2	8	80	0.38	Paving	8,574.88
<b>Total Fuel Used</b>						<b>367,103.15</b>
						<b>(Gallons)</b>

Construction Phase	Days of Operation
Demolition Phase	150
Site Preparation Phase	150
Grading Phase	450
Building Construction Phase	1,000
Paving Phase	300
Architectural Coating Phase	300
Total Days	2,350

### WORKER TRIPS

Constuction Phase	MPG [2]	Trips	Trip Length (miles)	Fuel Used (gallons)
Demolition	24.4	15	10.8	995.90
Site Prep Phase	24.4	18	10.8	1,195.08
Grading Phase	24.4	20	10.8	3,983.61
Building Phase	24.4	1,071	10.8	474,049.18
Paving Phase	24.4	15	10.8	1,991.80
Architectural Coating Phase	24.4	214	10.8	28,416.39
<b>Total</b>				<b>510,631.97</b>

### HAULING AND VENDOR TRIPS

Trip Class	MPG [2]	Trips	Trip Length (miles)	Fuel Used (gallons)
<b>HAULING TRIPS</b>				
Demolition	7.5	3,411	20.0	9,096.00
Site Prep Phase	7.5	-	20.0	-
Grading Phase	7.5	10,800	20.0	28,800.00
Building Phase	7.5	-	20.0	-
Paving Phase	7.5	-	20.0	-
Architectural Coating Phase	7.5	-	20.0	-
<b>Total</b>				<b>37,896.00</b>

<b>VENDOR TRIPS</b>				
Demolition	7.5	-	7.3	-
Site Prep Phase	7.5	-	7.3	-
Grading Phase	7.5	-	7.3	-
Building Phase	7.5	318	7.3	309,520.00
Paving Phase	7.5	-	7.3	-
Architectural Coating Phase	7.5	-	7.3	-
<b>Total</b>				<b>309,520.00</b>

<b>Total Gasoline Consumption (gallons)</b>	<b>510,631.97</b>
<b>Total Diesel Consumption (gallons)</b>	<b>714,519.15</b>

**Sources:**

[1] United States Environmental Protection Agency. 2018. *Exhaust and Crankcase Emission Factors for Nonroad Compression-Ignition Engines in MOVES2014b* . July 2018. Available at: <https://nepis.epa.gov/Exe/ZyPDF.cgi?Dockkey=P100UXEN.pdf>.

[2] United States Department of Transportation, Bureau of Transportation Statistics. 2018. *National Transportation Statistics 2018* . Available at: <https://www.bts.gov/topics/national-transportation-statistics>.



# Rezoning Sites for Housing

Last Updated: October 26, 2020

**Populate one of the following tables (Leave the other blank):**

<b>Annual VMT</b>	<b>OR</b>	<b>Daily Vehicle Trips</b>
Annual VMT: 34,011,855		Daily Vehicle Trips: Average Trip Distance:

Fleet Class	Fleet Mix	Fuel Economy (MPG)	
Light Duty Auto (LDA)	0.625329	Passenger Vehicles	24.4
Light Duty Truck 1 (LDT1)	0.031298	Light-Med Duty Trucks	17.9
Light Duty Truck 2 (LDT2)	0.162135	Heavy Trucks/Other	7.5
Medium Duty Vehicle (MDV)	0.089092	Motorcycles	44.0
Light Heavy Duty 1 (LHD1)	0.014618		
Light Heavy Duty 2 (LHD2)	0.004632		
Medium Heavy Duty (MHD)	0.032111		
Heavy Heavy Duty (HHD)	0.030354		
Other Bus (OBUS)	0.003196		
Urban Bus (UBUS)	0.001373		
School Bus (SBUS)	0.000897		
Motorhome (MH)	0.000662		
Motorcycle (MCY)	0.004305		

Fleet Mix					
Vehicle Type	Percent	Fuel Type	Annual VMT: VMT	Vehicle Trips: VMT	Fuel Consumption (Gallons)
Passenger Vehicles	62.53%	<i>Gasoline</i>	21,268,599	0.00	871,663.90
Light-Medium Duty Trucks	28.25%	<i>Gasoline</i>	9,609,199	0.00	536,826.78
Heavy Trucks/Other	8.78%	<i>Diesel</i>	2,987,703	0.00	398,360.45
Motorcycle	0.43%	<i>Gasoline</i>	146,421	0.00	3,327.75

<b>Total Gasoline Consumption (gallons)</b>	<b>1,411,818.43</b>
<b>Total Diesel Consumption (gallons)</b>	<b>398,360.45</b>

# Appendix TRA

---

Transportation Impact Assessment

# Memorandum

Date: August 26, 2020  
To: Darcy Kremin, Rincon Consultants, Inc.  
From: Ashlee Takushi and Ian Barnes, PE, Fehr & Peers  
Subject: **Summary of Transportation Assessment for Sonoma Housing Rezone Project**

WC20-3682

## Introduction and Background

Fehr & Peers has completed a transportation assessment of the Sonoma County Housing Rezone project, which aims to modify zoning at 59 Potential Sites throughout the unincorporated area of Sonoma County. The modifications to zoning allow for additional housing units to be developed beyond those currently envisioned as part of the County's adopted General Plan; accordingly, the effects of these additional housing units on the transportation system are required to be analyzed at a programmatic level. The assessment is comprised of two parts:

- An analysis of total home-based residential vehicle-miles traveled (VMT) per resident, as required by the California Environmental Quality Act (CEQA)
- An informational analysis of the program's projected effects on operations at select intersections in the County's circulation system (this analysis is not subject to CEQA per CEQA Guidelines Section 21099(b)(2))

The near-term baseline conditions (i.e. Existing Conditions) referred to in this assessment reflect conditions that prevailed prior to the COVID-19 pandemic which substantially affected transportation conditions within the study area during the spring and summer of 2020. The VMT data, traffic counts and other data used within the evaluation were collected prior to the pandemic. Subsequent forecasts of future conditions are based off models and predictions which do not account for the current, or potential on-going, effects that the pandemic may have on transportation demand. As the predominant effects of the pandemic have been an overall decrease in travel activity within the study area, this assessment likely provides a conservative estimate of transportation conditions.

The remainder of this memorandum outlines the assumptions, methods and outcomes of the analyses described.



## CEQA Vehicle-Miles Traveled Analysis

Senate Bill 743 (Steinberg, 2013) instructed the State Office of Planning and Research (OPR) to update the CEQA Guidelines to remove congestion-based analysis (such as Level of Service analysis) from CEQA Transportation analysis, and to install a new metric (vehicle-miles traveled, or VMT). The intent of SB 743 was to encourage infill development, promote healthier communities through active transportation (e.g. walking and bicycling), and align CEQA Transportation analysis to aid California in meeting greenhouse gas reduction targets set by other pieces of legislation (i.e. AB 32). Ultimately, SB 743 has shifted CEQA transportation analysis from measuring the effects on a project on drivers, to measuring the environmental effects of driving generated by a project. Adopted in December 2018, Section 15064.3 of the CEQA Guidelines notes that vehicle-miles traveled (VMT) is the most appropriate metric for the analysis of impacts in the Transportation section of CEQA analysis.

VMT measures the amount of driving that a project generates. For example, a project generating 100 total (inbound and outbound) vehicle trips per day that travel an average of 5.0 miles per trip results in 500 project-generated VMT per day. VMT has historically been used in CEQA as an input for the Air Quality and Greenhouse Gas sections, but VMT can also show how efficient the connection between the transportation system and existing or proposed land uses is. For the purposes of analyzing the CEQA Transportation impacts of residential projects, the VMT generated by the project is converted to an efficiency metric by dividing the amount of VMT generated by the number of residents; efficiency metrics are used in CEQA Transportation VMT analysis because the goal of the analysis is to show whether or not a particular development will generate low enough VMT to aid the State in meeting its climate targets relative to projected growth in population, employment, etc.

The State Office of Planning and Research (OPR) has provided guidance in its *Technical Advisory on Evaluating Transportation Impacts in CEQA* (December 2018) as to how the analysis of VMT could be performed and what CEQA thresholds of significance could be applied. The guidance in the *Technical Advisory* is non-binding; however, County staff have given direction that the metrics, methods and thresholds provided in the *Technical Advisory* should be used in the analysis. Based on this direction from the County in its capacity as a lead agency for CEQA purposes, the VMT analysis of the proposed program includes the following approach:

- Metric: Total weekday home-based VMT per resident
- Method: Sonoma County Transportation Authority (SCTA) countywide travel demand model



- Threshold: 15 percent below regional baseline (nine-county Bay Area) total weekday home-based VMT per resident<sup>1</sup>
- Analysis Scenario: Impacts evaluated against the near-term baseline (i.e. a Cumulative analysis is not required)

The summer 2020 version of the SCTA model has been refined to reflect a Year 2015 base year as well as to incorporate “Big Data” trip length estimates at the model gateways. The incorporation of Big Data trip length estimates provides a more precise understanding of the length of trips that occur beyond the County boundary, thus alleviating the trip length truncation issues associated with earlier versions of the model. New housing units were modeled assuming that 90 percent of the units would take the characteristics of multifamily housing, while the remaining 10 percent of the units would take the characteristics of single-family housing. These assumptions, while conservative, did not materially affect the outcomes of the VMT analysis (described further in this memorandum).

Based on data from MTC Travel Model One, the baseline value of the nine-county Bay Area average total home-based VMT per resident is 15.3. A threshold of 15 percent below this value is 13.0. The analysis is performed at the near-term baseline level; a Cumulative scenario analysis is also provided. Year 2015 conditions (as reflected in the SCTA and MTC models) was used as the baseline year because (1) the 2015 horizon year reflects conditions before the 2017 and 2019 Sonoma County wildfires and ongoing recovery effects, and (2) the 2015 horizon year reflects conditions before the COVID-19 pandemic, which has substantially altered transportation conditions in Sonoma County. Given that travel characteristics (i.e. trip lengths) in 2015 and 2016 are likely to be substantially similar as there were no major transportation network improvements nor major changes in the prevailing economic activity pattern, the Year 2015 horizon year is the most appropriate baseline year given current travel demand model information and the typical practice of avoiding the defining of baseline transportation conditions for periods when factors outside of economic activity or transportation network changes result in major disruptions to typical transportation conditions.

### **Potential Screening Opportunities**

VMT screening is a process related to reviewing the location and operating parameters of land use projects and programs to determine if a project or program does not need to perform a VMT analysis because it is presumed to generate a low amount of VMT. The *Technical Advisory* provides a number of potential screening criteria, including:

---

<sup>1</sup> The *Technical Advisory* notes that for land use projects or programs located in the unincorporated areas of a county that is included in an MPO region, the threshold should be based on (1) the region (i.e. MPO) VMT per capita or (2) the aggregate population-weighted VMT per capita of all incorporated cities and towns in the region (i.e. MPO).



- Development in a low VMT generating area per the SCTA travel model (relative to suggested CEQA impact criteria presented in the *Technical Advisory*)
- Development located within a 0.5 mile walkshed of an existing major transit stop or existing stop along a high-quality transit corridor
- Development in infill locations that are (1) 100 percent affordable and (2) in an area where a jobs/housing imbalance exists such that the infill development would promote shorter commute trips
- Small developments that generate or attract fewer than 110 trips per day (about 17 residential units in suburban areas)

All Potential Sites under consideration do not meet the transit proximity or low VMT generating area definitions. Depending on the conditions placed on the Potential Sites, some sites may qualify for the affordable infill housing exemption, and some sites may be sufficiently small that they do not generate more than 110 trips per day. Based on the proposed zoning changes, it is anticipated that the following parcels would generate less than 110 trips per day if they were to be built out at the density proposed under the Program: GLE-2, LAR-4, PEN-1, and PEN-3. Projects on these sites may be exempted from required mitigation if a significant VMT impact is found (discussed later in this document).

Given the programmatic effort envisioned as part of the project, it was assumed that all Potential Sites would be incorporated into the analysis, including those that are small enough to potentially meet the small development screening criteria discussed above. Entitlements for development on sites rezoned as part of the program may then tier off of this transportation assessment and the EIR for the program as a whole.

### Program-Level VMT Analysis

Home-based VMT per resident data from the July 2020 version of the SCTA model (the most recent available version) were output for the Base Year (Year 2015), Base Year plus Program, Cumulative (Year 2040), and Cumulative plus Program scenarios. Data from program-affected traffic analysis zones (TAZs) in the model were considered as part of the analysis. The results of the analysis are presented below in **Table 1**.

**Table 1: Home-Based Residential VMT per Resident Analysis**

Scenario	Program TAZs		Impact?
	Total Home-Based VMT per Resident	Threshold Value	
Base Year (Year 2015)	16.4	N/A	N/A
Base Year + Program	16.0	13.0	<b>Yes</b>
Cumulative (Year 2040)	14.8	N/A	N/A
Cumulative + Program	14.8	13.0	<b>Yes</b>

Source: Fehr & Peers, July 2020.



As noted in **Table 1**, the program's effect on VMT in the affected TAZs is a small decrease in average total home-based VMT per resident. However, the resulting value of 16.0 is greater than the threshold value of 13.0, and thus the program would result in a **significant impact**. It is noted that the net change VMT value for the "new" housing units was about 14.7, which is above the threshold value. The Cumulative scenario analysis showed a minor reduction in total home-based VMT per resident (less than 0.1); if Cumulative scenario analysis is considered to be part of the CEQA analysis, then it would also be considered a **significant impact**.

### Mitigation Measures

Based on the results in **Table 1**, mitigation measures, if feasible, would need to reduce program TAZ VMT per resident by 3.0 VMT per resident, which represents a reduction of about 18.8 percent below the Base Year plus Program value of 16.0 VMT per resident. If mitigation measures were to be designed to reduce solely the net increment of change in VMT per resident (13.0), this 1.7 VMT per resident reduction represents an 11.5 percent reduction in the Base Year plus Program value of 14.7.

Transportation Demand Management (TDM) strategies work best when they are applied at a city or regional scale and when the travel characteristics of the users or tenants of a site are known. The proposed program aims to rezone 59 Potential Sites in 11 distinct subareas throughout Sonoma County, and the timeline for construction of the housing units envisioned as part of this program is unknown. Because of the large-scale geographic spread of the Potential Sites, and uncertainty regarding the buildout of the Potential Sites, the County should consider implementing a TDM ordinance or other TDM-related policies as part of the next General Plan update.

Additionally, the effectiveness of TDM measures for land use projects in unincorporated areas of Sonoma County is difficult to quantify as the literature documenting the effectiveness of land use project-level TDM strategies are generally related to suburban and urban areas, not unincorporated areas. Studies<sup>2</sup> show the maximum VMT reduction that can be expected for projects located within suburban settings in California ranges from 5 to 10 percent. The requirement to reduce daily VMT and vehicle trips by 11.5 percent (depending on the calculation method chosen) exceeds the range of trip reduction for communities similar to Sonoma County. However, while the level of VMT reduction associated with TDM measures are unlikely to mitigate the program's impact to a less-than-significant level, CEQA requires that feasible mitigation measures be implemented to reduce a project or program's level of impact.

---

<sup>2</sup> *Quantifying Greenhouse Gas Mitigation Measures: A Resource for Local Government to Assess Emission Reductions from Greenhouse Gas Mitigation Measures*, California Air Pollution Control Officers Association, August, 2010, page 55.



**Mitigation Measure 1: TDM Program.** Prior to issuance of building permits, project applicants shall develop a TDM program for the proposed project, including any anticipated phasing, and shall submit the TDM Program to the County Department of Transportation and Public Works for review and approval. The TDM Program shall identify trip reduction strategies as well as mechanisms for funding and overseeing the delivery of trip reduction programs and strategies. The TDM Program shall be designed to achieve the following trip reduction, as required to meet thresholds identified by OPR:

- Reduce daily VMT and vehicle trips, as forecast for the project, by 11.5 percent.

Trip reduction strategies may include, but are not limited to, the following:

1. Provision of bus stop improvements or on-site mobility hubs
2. Pedestrian improvements, on-site or off-site, to connect to nearby transit stops, services, schools, shops, etc.
3. Bicycle programs including bike purchase incentives, storage, maintenance programs, and on-site education program
4. Enhancements to countywide bicycle network
5. Parking reductions and/or fees set at levels sufficient to incentivize transit, active transportation, or shared modes
6. Cash allowances, passes, or other public transit subsidies and purchase incentives
7. Enhancements to bus service
8. Implementation of shuttle service
9. Establishment of carpool, buspool, or vanpool programs
10. Vanpool purchase incentives
11. Low emission vehicle purchase incentives/subsidies
12. Compliance with a future County VMT/TDM ordinance
13. Participation in a future County VMT fee program
14. Participate in future VMT exchange or mitigation bank programs

Development at Potential Sites GLE-2, LAR-4, PEN-1 and PEN-3 may be exempt from the development of a TDM program as the weekday trip generation for these developments would be less than 110 trips per weekday under the Program. As the above TDM strategies are heavily dependent on context, a matrix detailing which TDM strategies may be most effective when taking in account local contexts (by Potential Site group) has been included as **Table 2** (presented on page 8).

The VMT forecasts presented in this assessment do not take into consideration some foreseeable travel changes, including increased use of transportation network companies, such as Uber and





Lyft, nor the potential for autonomous vehicles. Although the technology for autonomous vehicles is expected to be available over the planning horizon, the federal and State legal and policy frameworks are uncertain. Initial modeling of an autonomous future indicates that with automated and connected vehicles, the capacity of the existing transportation system would increase as vehicles can travel closer together; however, these efficiencies are only realized when a high percentage of vehicles on the roadway are automated and connected. There is also the potential for vehicle travel to increase with zero-occupancy vehicles on the roadway. Additionally, the VMT forecasts are based on a model that was developed using data reflecting travel conditions before COVID-19; the effects of COVID-19 may be a near-term suppression in travel activity on the basis of reduced economic output and permanently modified travel habits.

However, a TDM program would likely not result in the 11.5 percent or 18.8 percent reductions required, and thus the impact is **significant and unavoidable**.



**Table 2: Potential Effectiveness of TDM Strategies by Potential Site Group**

TDM Strategy	AGU	FOR	GEY	GLE	GRA	GUE	LAR	PEN	PET	SAN	SON
1. Provision of bus stop improvements or on-site mobility hubs	M	M	M	M	M	H	H	H	L	H	H
2. Pedestrian improvements, on-site or off-site, to connect to nearby transit stops, services, schools, shops, etc.	M	H	H	M	M	H	H	H	M	H	H
3. Bicycle programs including bike purchase incentives, storage, maintenance programs, and on-site education program	M	H	H	M	M	H	H	M	M	H	M
4. Enhancements to countywide bicycle network	M	M	M	M	M	M	H	M	M	H	M
5. Parking reductions and/or fees set at levels sufficient to incentivize transit, active transportation, or shared modes	H	H	H	H	H	H	H	H	H	H	H
6. Cash allowances, passes, or other public transit subsidies and purchase incentives	H	H	H	H	H	H	H	H	M	H	H
7. Enhancements to bus service	H	H	H	H	H	H	H	H	M	H	H
8. Implementation of shuttle service	M	H	M	M	M	H	H	H	H	H	H
9. Establishment of carpool, buspool, or vanpool programs	M	M	M	M	M	H	H	H	M	H	H
10. Vanpool purchase incentives	L	L	L	L	L	M	H	M	L	H	M
11. Low emission vehicle purchase incentives/subsidies	H	H	H	H	H	H	H	H	H	H	H
12. Compliance with a future County VMT/TDM ordinance	H	H	H	H	H	H	H	H	H	H	H
13. Participation in a future County VMT fee program	H	H	H	H	H	H	H	H	H	H	H
14. Participate in future VMT exchange or mitigation bank programs	H	H	H	H	H	H	H	H	H	H	H

Notes:

Potential effectiveness ratings: L = low, M = medium, H = high

Based on CAPCOA research, global maximum VMT reduction using all TDM measures for projects in rural and suburban contexts is 5-10 percent

Potential effectiveness of strategies based on Potential Site Group density, access to transit, and nearby destinations within walking or bicycling distance

Source: Fehr & Peers, July 2020.



## Informational (Non-CEQA) Intersection Operations Analysis

Intersection operations analysis was performed at 20 intersections throughout Sonoma County located near the 59 Potential Sites. The 20 intersections, their locations within Sonoma County, and nearby Potential Sites are presented in **Table 3**.

**Table 3: Study Intersections**

No.	Intersection	Intersection Control <sup>1</sup>	Area of County	Adjacent/Nearby Potential Sites
1	Geyserville Ave/Canyon Rd	AWSC	Geyserville	GEY-1 through GEY-4
2	River Rd (SR 116)/Armstrong Woods Rd-First St	Signal	Guerneville <sup>C</sup>	GUE-1 through GUE-4
3	River Rd/Gravenstein Hwy (SR 116)	Signal	Guerneville <sup>C</sup>	GUE-1 through GUE-4
4	Old Redwood Hwy/Fulton Rd	SSSC	Larkfield/Wikiup	LAR-1 through LAR-8
5	Airport Blvd/Fulton Rd	Signal	Larkfield/Wikiup	LAR-1 through LAR-8
6	Old Redwood Hwy/Airport Blvd	Signal	Larkfield/Wikiup	LAR-1 through LAR-8
7	Old Redwood Hwy/Faught Rd	SSSC	Larkfield/Wikiup	LAR-1 through LAR-8
8	Old Redwood Hwy/Wikiup Dr-Mark West Commons Cir	Signal	Larkfield/Wikiup	LAR-1 through LAR-8
9	Front St (SR 116)/Mirabel Rd	SSSC	Forestville <sup>C</sup>	FOR-1 through FOR-6 GUE-1 through GUE-4 <sup>2</sup>
10	Gravenstein Hwy (SR 116)/Graton Rd-Frei Rd	Signal	Graton <sup>C</sup>	GRA-1 through GRA-5
11	Todd Rd/Moorland Ave	SSSC	South Santa Rosa	SAN-1 through SAN-10
12	Todd Rd/South Moorland Ave/US 101 Southbound Ramps	Signal	South Santa Rosa <sup>C</sup>	SAN-1 through SAN-10
13	Todd Rd/Todd Rd Overcrossing	Signal	South Santa Rosa <sup>C</sup>	SAN-1 through SAN-10
14	Todd Rd/Santa Rosa Ave	Signal	South Santa Rosa	SAN-1 through SAN-10
15	Arnold Dr/Warm Springs Rd	AWSC	Glen Ellen	GLE-1 and GLE-2
16	Verano Ave/Riverside Dr	SSSC	Agua Caliente	AGU-1 through AGU-3
17	Adobe Rd/Petaluma Hill Rd-Main St	Signal	Penngrove	PEN-1 through PEN-9
18	Old Redwood Hwy/Main St	Signal	Penngrove	PEN-1 through PEN-9
19	Bodega Ave/Paula Ln	SSSC	Petaluma	PET-1 through PET-4
20	Broadway (SR 12)/Leveroni Rd-Napa Rd	Signal	Sonoma <sup>C</sup>	SON-1 through SON-4

Notes:

1. AWSC = All-Way Stop-Controlled, SSSC= Side-Street Stop-Controlled

2. Potential Sites GUE-1 through GUE-4 also contribute a substantial number of AM and PM peak hour trips to this intersection.

<sup>C</sup> indicates a Caltrans intersection

Source: Fehr & Peers, July 2020.



## Analysis Methods, Parameters and Substantial Effect Criteria

Intersection operations analysis was performed for Existing, Existing plus Program, Cumulative (Year 2040), and Cumulative plus Program Conditions. Year 2040 forecasts were developed using outputs from the SCTA travel demand model, and program-generated traffic volumes were estimated using the outputs from the Base Year (without program) and Base Year plus Program SCTA model runs. Cumulative scenario analysis was performed assuming no changes to intersection configurations or signal timings in order to assess whether they would contribute to projected operations deficiencies related to the County's Level of Service (LOS) D operations policy, and whether projects resulting from the program should contribute funds to previously-identified improvements at intersections that are projected to operate deficiently before the implementation of the program.

The analysis was performed for the weekday AM and PM peak hours, consistent with the County's *Guidelines for Traffic Impact Studies*, which use intersection LOS as a basis for measuring the operating conditions of intersections. The *Highway Capacity Manual, 6<sup>th</sup> Edition* was used as the methodology for the analysis. Delay and LOS definitions are provided in **Attachment A**. The following criteria were used in the analysis to identify substantial operations effects. Intersection improvement measures have been identified in cases where the program would result in substantial intersection operations effects.

### *Signalized Intersections*

A substantial operation effect would occur if:

- For intersections operating acceptably before the addition of program-generated traffic (LOS D or better): The addition of program-generated traffic results in operations degrading from LOS A, B, C, or D to LOS E or F.
- For intersections operating unacceptably before the addition of program-generated traffic (LOS E or LOS F): The addition of program-generated traffic results in an increase in average delay of 5.0 seconds or more.

### *Stop-Controlled Intersections*

A substantial operation effect would occur if:

- For intersections operating acceptably before the addition of program-generated traffic (LOS D or better): The addition of program-generated traffic results in operations degrading from LOS A, B, C, or D to LOS E or F, and the Peak Hour Signal Warrant is met.
- For side-street stop-controlled intersections operating unacceptably before the addition of program-generated traffic (LOS E or LOS F): The addition of program-generated traffic results in an increase in delay on the worst movement or approach of 5.0 seconds or more, and the Peak Hour Signal Warrant is met.



- For all-way stop-controlled intersections operating unacceptably before the addition of program-generated traffic (LOS E or LOS F): The addition of program-generated traffic results in an increase in average delay of 5.0 seconds or more, and the Peak Hour Signal Warrant is met.

### **Near-Term (Existing and Existing plus Program) Conditions Analysis**

This section presents the results of the near-term operations analysis, comprised of Existing Conditions and Existing plus Program Conditions. Because of the long-term nature of the program, the assumption that all development facilitated by the program would occur in the short-term is conservative.

#### *Intersection Operations Analysis*

Intersection operations for Existing Conditions were analyzed using existing signal timing data, lane configurations, and traffic volume data from the StreetLight Data traffic volume estimate database, which leverages location-based service data from cellular devices to estimate traffic volumes. Year 2019 data from non-holiday Tuesdays, Wednesdays and Thursdays from the months of February, March, April, May, September, October, and November were used to estimate traffic volumes for 2019 conditions; the estimates were compared against count data from the County's database or other studies, where available. This approach reflects conditions before the COVID-19 pandemic and associated economic and travel effects. Generally, the StreetLight Data process slightly overestimates traffic volumes against counts; however, because traditional traffic counts are performed for only one day and the StreetLight Data method uses data from nearly 90 days, the StreetLight Data method better accounts for day-to-day fluctuations in traffic volumes. Existing Conditions volumes are presented in **Attachment B as Figure 1**.

Intersection operations Existing with Program Conditions were analyzed by adding program-generated traffic volume (per the SCTA model) to the Existing Conditions models. Existing with Program Conditions traffic volumes are included in **Attachment B as Figure 2**; signal timing and lane configurations were held constant. The results of the near-term intersection operations analysis are presented in **Table 4**. Intersection analysis model outputs are provided in **Attachment C**.



**Table 4: Near-Term Intersection Operations Analysis**

	Intersection	Peak Hour	Existing Conditions		Existing plus Program Conditions		
			Delay <sup>1</sup>	LOS <sup>2</sup>	Delay <sup>1</sup>	LOS <sup>2</sup>	Δ Delay <sup>3</sup>
1	Geyserville Ave/Canyon Rd	AM	8.3	A	8.6	A	+0.3
		PM	8.5	A	8.8	A	+0.3
2	River Rd (SR 116)/Armstrong Woods Rd-First St	AM	8.4	A	9.3	A	+0.9
		PM	8.9	A	9.6	A	+0.7
3	River Rd/Gravenstein Hwy (SR 116)	AM	8.7	A	9.0	A	+0.3
		PM	9.7	A	10.0	B	+0.3
4	Old Redwood Hwy/Fulton Rd	AM	3.6 (26.7)	A (D)	3.7 (27.7)	A (D)	+0.1 (+1.0)
		PM	<b>45.9 (&gt;120)</b>	<b>E (F)</b>	<b>53.0 (&gt;120)</b>	<b>F (F)</b>	<b>**</b>
5	Airport Blvd/Fulton Rd	AM	>120	<b>F</b>	>120	<b>F</b>	<b>+4.9</b>
		PM	<b>107.1</b>	<b>F</b>	<b>111.3</b>	<b>F</b>	<b>+4.2</b>
6	Old Redwood Hwy/Airport Blvd	AM	<b>58.2</b>	<b>E</b>	<b>62.9</b>	<b>E</b>	<b>+4.7</b>
		PM	19.6	B	19.7	B	+0.1
7	Old Redwood Hwy/Faught Rd	AM	<b>41.5 (&gt;120)</b>	<b>E (F)</b>	<b>46.8 (&gt;120)</b>	<b>E (F)</b>	<b>**</b>
		PM	<b>22.2 (&gt;120)</b>	<b>C (F)</b>	<b>24.7 (&gt;120)</b>	<b>C (F)</b>	<b>**</b>
8	Old Redwood Hwy/Wikiup Dr-Mark West Commons Cir	AM	16.1	B	20.3	C	+4.2
		PM	15.3	B	18.3	B	+3.0
9	Front St (SR 116)/Mirabel Rd	AM	9.7 (24.9)	A (C)	<b>15.0 (39.0)</b>	<b>B (E)</b>	<b>+5.3 (+14.1)</b>
		PM	4.5 (15.5)	A (C)	5.4 (18.8)	A (C)	+0.9 (+3.3)
10	Gravenstein Hwy (SR 116)/Graton Rd-Frei Rd	AM	15.2	B	15.7	B	+0.5
		PM	16.4	B	16.9	B	+0.5
11	Todd Rd/Moorland Ave	AM	<b>87.9 (&gt;120)</b>	<b>F (F)</b>	<b>&gt;120 (&gt;120)</b>	<b>F (F)</b>	<b>**</b>
		PM	<b>&gt;120 (&gt;120)</b>	<b>F (F)</b>	<b>&gt;120 (&gt;120)</b>	<b>F (F)</b>	<b>**</b>
12	Todd Rd/South Moorland Ave/US 101 Southbound Ramps	AM	21.4	C	36.1	D	+14.7
		PM	29.7	C	<b>56.7</b>	<b>E</b>	<b>+27.0</b>
13	Todd Rd/Todd Rd Overcrossing	AM	9.0	A	10.0	A	+1.0
		PM	9.6	A	10.8	B	+1.2
14	Todd Rd/Santa Rosa Ave	AM	20.6	C	23.0	C	+2.4
		PM	31.9	C	36.8	D	+4.9
15	Arnold Dr/Warm Springs Rd	AM	11.4	B	11.4	B	+0.0
		PM	11.0	B	11.2	B	+0.2
16	Verano Ave/Riverside Dr	AM	<b>11.3 (44.9)</b>	<b>B (E)</b>	<b>15.3 (64.6)</b>	<b>C (F)</b>	<b>+4.0 (+19.7)</b>
		PM	<b>31.3 (&gt;120)</b>	<b>D (F)</b>	<b>53.1 (&gt;120)</b>	<b>F (F)</b>	<b>**</b>
17	Adobe Rd/Petaluma Hill Rd-Main St	AM	47.4	D	53.5	D	+6.1
		PM	>120	<b>F</b>	>120	<b>F</b>	<b>+4.0</b>
18	Old Redwood Hwy/Main St	AM	14.0	B	14.7	B	+0.7
		PM	23.8	C	26.3	C	+2.5
19	Bodega Ave/Paula Ln	AM	1.5 (21.7)	A (C)	2.8 (28.7)	A (D)	+1.3 (+7.0)
		PM	1.0 (16.3)	A (C)	2.1 (20.9)	A (C)	+1.1 (+4.6)



**Table 4: Near-Term Intersection Operations Analysis**

	Intersection	Peak Hour	Existing Conditions		Existing plus Program Conditions		
			Delay <sup>1</sup>	LOS <sup>2</sup>	Delay <sup>1</sup>	LOS <sup>2</sup>	Δ Delay <sup>3</sup>
20	Broadway (SR 12)/Leveroni Rd- Napa Rd	AM	49.3	D	50.1	D	+0.8
		PM	45.8	D	46.0	D	+0.2

Notes:

**Bold** indicates operations below the County's LOS D standard. **Bold and highlighted** indicates a substantial operations effect.

1. Delay for signalized intersections and All-Way Stop-Controlled intersections presented whole-intersection average delay. Delay for Side-Street Stop-Controlled intersections presented as: whole-intersection average delay (delay on worst movement or single-lane approach).

2. LOS per *Highway Capacity Manual, 6<sup>th</sup> Edition*

3. Change in delay between Existing plus Program Conditions and Existing Conditions

\*\* indicates that the Synchro program is indicating that the intersection is supersaturated, and the change in delay values are likely greater than 5.0 seconds on the worst movement or single-lane approach.

Source: Fehr & Peers, July 2020.

### Signal Warrant Analysis

The Peak Hour Signal Warrant (Warrant 3B) analysis was performed for intersections that operate unacceptably with respect to the County's LOS D operations standard under Existing Conditions or Existing plus Program Conditions. Signal warrant worksheets are provided in **Attachment D**. Traffic volumes at the following intersections meet the Peak Hour Signal Warrant for the time periods noted:

- Old Redwood Highway/Fulton Road (Existing Conditions, PM peak hour)
- Front Street (SR 116)/Mirabel Road (Existing plus Program Conditions, AM peak hour)
- Todd Road/Moorland Avenue (Existing Conditions, AM and PM peak hours)

Traffic volumes at all other unsignalized intersections operating unacceptably do not meet the Peak Hour Signal Warrant under Existing Conditions or Existing plus Program Conditions.

### Findings

Based on the results in **Table 4** and the Peak Hour Signal Warrant analysis, the program would have a substantial effect on intersection operations at the following locations during the time periods noted:

- Intersection 4: Old Redwood Highway/Fulton Road (PM peak hour) – The addition of traffic from Potential Sites LAR-1 through LAR-8 exacerbates unacceptable LOS F conditions by increasing delay by more than 5.0 seconds and the Peak Hour Signal Warrant is met.
- Intersection 9: Front Street (SR 116)/Mirabel Road (AM Peak hour) – The addition of traffic from Potential Sites FOR-1 through FOR-6 and Potential Sites GUE-1 through GUE-4



- causes operations to degrade from an acceptable LOS C to an unacceptable LOS E and the Peak Hour Signal Warrant is met.
- Intersection 11: Todd Road/Moorland Avenue (AM and PM peak hours) – The addition of traffic from Potential Sites SAN-1 through SAN-10 exacerbates unacceptable LOS E/F conditions by increasing delay by more than 5.0 seconds and the Peak Hour Signal Warrant is met.
  - Intersection 12: Todd Road/South Moorland Avenue/US 101 southbound ramps (PM peak hour) – The addition of traffic from Potential Sites SAN-1 through SAN-10 causes operations at the intersection to degrade from an acceptable LOS C to an unacceptable LOS E.

It is noted that the substantial effects at Old Redwood Highway/Fulton Road and Todd Road/Moorland Avenue are cases where the intersection operates unacceptably before the development at Potential Sites LAR-1 through LAR-8 and Potential Sites SAN-1 through SAN-10 (respectively). The substantial effects at Front Street (SR 116)/Mirabel Road is a case where development at Potential Sites FOR-1 through FOR-6 and Potential Sites GUE-1 through GUE-4 results in a new deficiency; a similar situation occurs for the intersection of Todd Road/South Moorland Avenue/US 101 southbound ramps with respect to the addition of traffic generated by Potential Sites SAN-1 through SAN-10.

Because all of the development is not anticipated to be built in the near-term, the substantial effects noted above may take years to materialize. Thus, no near-term intersection improvements have been identified as required, and the Cumulative scenario improvements will be the main focus of improvements for further consideration.

### **Cumulative (Year 2040) Conditions Analysis**

This section presents the results of the Cumulative (Year 2040) operations analysis, comprised of Cumulative (without Program) Conditions and Cumulative plus Program Conditions. The Cumulative (Year 2040) horizon assumes that all long-range development (except the program being studied) from all agencies in Sonoma County is built, as modeled in the SCTA model. The analysis assumes that the transportation network and signal timing parameters are held to Existing Conditions to provide a conservative baseline and to assess if development proposed by the program should contribute to planned transportation system improvements already in the project pipeline.

#### *Intersection Operations Analysis*

Intersection operations Cumulative Conditions were analyzed by growing Existing Conditions volumes using growth factors derived from SCTA model outputs; traffic volume information for Cumulative Conditions are included in **Attachment B as Figure 3**. Cumulative with Program Conditions traffic volumes are included in **Attachment B as Figure 4**. The results of the





Cumulative intersection operations analysis are presented in **Table 5**. Intersection analysis model outputs are provided in **Attachment C**.

**Table 5: Cumulative Conditions Intersection Operations Analysis**

	Intersection	Peak Hour	Cumulative Conditions		Cumulative plus Program Conditions		
			Delay <sup>1</sup>	LOS <sup>2</sup>	Delay <sup>1</sup>	LOS <sup>2</sup>	Δ Delay <sup>3</sup>
1	Geyserville Ave/Canyon Rd	AM	9.2	A	9.5	A	+0.3
		PM	9.4	A	9.8	A	+0.4
2	River Rd (SR 116)/Armstrong Woods Rd-First St	AM	10.9	B	12.9	B	+2.0
		PM	10.8	B	12.4	B	+1.6
3	River Rd/Gravenstein Hwy (SR 116)	AM	10.6	B	11.1	B	+0.5
		PM	12.6	B	14.2	B	+1.6
4	Old Redwood Hwy/Fulton Rd	AM	<b>12.7 (113.8)</b>	<b>B (F)</b>	<b>13.8 (&gt;120)</b>	<b>B (F)</b>	<b>**</b>
		PM	<b>&gt;120 (&gt;120)</b>	<b>F (F)</b>	<b>&gt;120 (&gt;120)</b>	<b>F (F)</b>	<b>**</b>
5	Airport Blvd/Fulton Rd	AM	<b>&gt;120</b>	<b>F</b>	<b>&gt;120</b>	<b>F</b>	<b>+5.3</b>
		PM	<b>&gt;120</b>	<b>F</b>	<b>&gt;120</b>	<b>F</b>	<b>+4.0</b>
6	Old Redwood Hwy/Airport Blvd	AM	<b>&gt;120</b>	<b>F</b>	<b>&gt;120</b>	<b>F</b>	<b>+3.7</b>
		PM	37.8	D	38.7	D	+0.9
7	Old Redwood Hwy/Faught Rd	AM	<b>&gt;120 (&gt;120)</b>	<b>F (F)</b>	<b>&gt;120 (&gt;120)</b>	<b>F (F)</b>	<b>**</b>
		PM	<b>&gt;120 (&gt;120)</b>	<b>F (F)</b>	<b>&gt;120 (&gt;120)</b>	<b>F (F)</b>	<b>**</b>
8	Old Redwood Hwy/Wikiup Dr-Mark West Commons Cir	AM	39.2	D	51.4	D	+12.2
		PM	<b>64.9</b>	<b>E</b>	<b>72.8</b>	<b>E</b>	<b>+7.9</b>
9	Front St (SR 116)/Mirabel Rd	AM	<b>100.5 (&gt;120)</b>	<b>F (F)</b>	<b>&gt;120 (&gt;120)</b>	<b>F (F)</b>	<b>**</b>
		PM	<b>18.7 (78.4)</b>	<b>C (F)</b>	<b>31.9 (&gt;120)</b>	<b>C (F)</b>	<b>**</b>
10	Gravenstein Hwy (SR 116) /Graton Rd-Frei Rd	AM	24.2	C	27.1	C	+2.9
		PM	35.3	D	36.7	D	+1.4
11	Todd Rd/Moorland Ave	AM	<b>&gt;120 (&gt;120)</b>	<b>F (F)</b>	<b>&gt;120 (&gt;120)</b>	<b>F (F)</b>	<b>**</b>
		PM	<b>&gt;120 (&gt;120)</b>	<b>F (F)</b>	<b>&gt;120 (&gt;120)</b>	<b>F (F)</b>	<b>**</b>
12	Todd Rd/South Moorland Ave/US 101 Southbound Ramps	AM	41.5	D	<b>69.6</b>	<b>E</b>	<b>+28.1</b>
		PM	<b>75.0</b>	<b>E</b>	<b>&gt;120</b>	<b>F</b>	<b>+48.3</b>
13	Todd Rd/Todd Rd Overcrossing	AM	9.7	A	10.8	B	+1.1
		PM	10.1	B	11.6	B	+1.5
14	Todd Rd/Santa Rosa Ave	AM	23.2	C	26.4	C	+3.2
		PM	41.0	D	47.3	D	+6.3
15	Arnold Dr/Warm Springs Rd	AM	13.6	B	13.7	B	+0.1
		PM	13.5	B	13.6	B	+0.1
16	Verano Ave/Riverside Dr	AM	<b>26.6 (113.9)</b>	<b>D (F)</b>	<b>38.8 (&gt;120)</b>	<b>E (F)</b>	<b>**</b>
		PM	<b>91.5 (&gt;120)</b>	<b>F (F)</b>	<b>&gt;120 (&gt;120)</b>	<b>F (F)</b>	<b>**</b>
17	Adobe Rd/Petaluma Hill Rd-Main St	AM	<b>&gt;120</b>	<b>F</b>	<b>&gt;120</b>	<b>F</b>	<b>+12.1</b>
		PM	<b>&gt;120</b>	<b>F</b>	<b>&gt;120</b>	<b>F</b>	<b>+4.6</b>



**Table 5: Cumulative Conditions Intersection Operations Analysis**

Intersection	Peak Hour	Cumulative Conditions		Cumulative plus Program Conditions		
		Delay <sup>1</sup>	LOS <sup>2</sup>	Delay <sup>1</sup>	LOS <sup>2</sup>	Δ Delay <sup>3</sup>
18 Old Redwood Hwy/Main St	AM	27.4	C	33.4	C	+6.0
	PM	<b>90.0</b>	<b>F</b>	<b>97.4</b>	<b>F</b>	<b>+7.4</b>
19 Bodega Ave/Paula Ln	AM	2.2 (27.5)	A (D)	<b>3.9 (39.4)</b>	<b>A (E)</b>	<b>+1.7 (+11.9)</b>
	PM	1.5 (21.0)	A (C)	2.8 (28.5)	A (D)	+1.3 (+7.5)
20 Broadway (SR 12)/Leveroni Rd-Napa Rd	AM	<b>66.2</b>	<b>E</b>	<b>66.9</b>	<b>E</b>	<b>+0.7</b>
	PM	<b>59.3</b>	<b>E</b>	<b>59.5</b>	<b>E</b>	<b>+0.2</b>

Notes:

**Bold** indicates operations below the County's LOS D standard. **Bold and highlighted** indicates a substantial operations effect.

1. Delay for signalized intersections and All-Way Stop-Controlled intersections presented whole-intersection average delay. Delay for Side-Street Stop-Controlled intersections presented as: whole-intersection average delay (delay on worst movement or single-lane approach).

2. LOS per *Highway Capacity Manual, 6<sup>th</sup> Edition*

3. Change in delay between Cumulative plus Program and Cumulative Conditions

\*\* indicates that the Synchro program is indicating that the intersection is supersaturated, and the change in delay values are likely greater than 5.0 seconds on the worst movement or single-lane approach.

Source: Fehr & Peers, July 2020.

### Signal Warrant Analysis

The Peak Hour Signal Warrant (Warrant 3B) analysis was performed for intersections that operate unacceptably with respect to the County's LOS D operations standard under Cumulative Conditions or Cumulative plus Program Conditions. Signal warrant worksheets are provided in **Attachment D**. Traffic volumes at the following intersections meet the Peak Hour Signal Warrant for the time periods noted:

- Old Redwood Highway/Fulton Road (Cumulative Conditions, AM and PM peak hours)
- Old Redwood Highway/Faught Road (Cumulative Conditions, AM and PM peak hours)
- Front Street (SR 116)/Mirabel Road (Cumulative Conditions, AM and PM peak hours)
- Todd Road/Moorland Avenue (Cumulative Conditions, AM and PM peak hours)
- Verano Avenue/Riverside Drive (Cumulative Conditions, PM peak hour)

Traffic volumes at all other unsignalized intersections operating unacceptably do not meet the Peak Hour Signal Warrant under Cumulative Conditions or Cumulative plus Program Conditions.

### Findings

Based on the results in **Table 5** and the Peak Hour Signal Warrant analysis, the program would have a substantial effect on intersection operations at the following locations during the time periods noted:



- Intersection 4: Old Redwood Highway/Fulton Road (AM and PM peak hours) – The addition of traffic development at Potential Sites LAR-1 through LAR-8 exacerbates unacceptable LOS F conditions by increasing the delay by more than 5.0 seconds and the Peak Hour Signal Warrant is met.
- Intersection 5: Airport Boulevard/Fulton Road (AM peak hour) – The addition of traffic development at Potential Sites LAR-1 through LAR-8 exacerbates unacceptable LOS F conditions by increasing the delay by more than 5.0 seconds.
- Intersection 7: Old Redwood Highway/Faught Road (AM and PM peak hours) - The addition of traffic development at Potential Sites LAR-1 through LAR-8 exacerbates unacceptable LOS F conditions by increasing the delay by more than 5.0 seconds and the Peak Hour Signal Warrant is met.
- Intersection 8: Old Redwood Highway/Wikiup Drive-Mark West Commons Circle (PM peak hour) - The addition of traffic development at Potential Sites LAR-1 through LAR-8 exacerbates unacceptable LOS F conditions by increasing the delay by more than 5.0 seconds.
- Intersection 9: Front Street (SR 116)/Mirabel Road (AM and PM peak hours) – The addition of traffic development at Potential Sites FOR-1 through FOR-6 and Potential Sites GUE-1 through GUE-4 exacerbates unacceptable LOS F conditions by increasing the delay by more than 5.0 seconds and the Peak Hour Signal Warrant is met.
- Intersection 11: Todd Road/Moorland Avenue (AM and PM peak hours) – The addition of traffic development at Potential Sites SAN-1 through SAN-10 exacerbates unacceptable LOS F conditions by increasing the delay by more than 5.0 seconds and the Peak Hour Signal Warrant is met.
- Intersection 12: Todd Road/South Moorland Avenue/US 101 southbound ramps (AM and PM peak hours) – The addition of traffic development at Potential Sites SAN-1 through SAN-10 exacerbates unacceptable LOS F conditions by increasing the delay by more than 5.0 seconds.
- Intersection 16: Verano Avenue/Riverside Drive (AM and PM peak hours) - The addition of traffic development at Potential Sites AGU-1 through AGU-3 exacerbates unacceptable LOS F conditions by increasing the delay by more than 5.0 seconds and the Peak Hour Signal Warrant is met.
- Intersection 17: Old Adobe Road/Petaluma Hill Road-Main Street (AM peak hour) - The addition of traffic development at Potential Sites PEN-1 through PEN-9 exacerbates unacceptable LOS F conditions by increasing the delay by more than 5.0 seconds.
- Intersection 18: Old Redwood Highway/Main Street (PM peak hour) - The addition of traffic development at Potential Sites PEN-1 through PEN-9 exacerbates unacceptable LOS F conditions by increasing the delay by more than 5.0 seconds.

It is noted that the identified substantial effects under Cumulative Conditions are almost exclusively cases where the program would exacerbate operations that would already be unacceptable prior to the addition of program traffic (i.e. intersections are projected to operate at



LOS E or F without the implementation of the program). Generally, this suggests that the projects should be conditioned to contribute a fair share amount towards improvements. The identified improvements to improve conditions at the identified locations of substantial effects are presented in the next subsection.

#### *Improvement Measures*

As noted previously, buildout of the program will take years to complete, and thus the program's effects on operations at study intersections will similarly take years to occur. Therefore, the improvements noted below have been developed to alleviate the effects of the program under Cumulative conditions. Many of the improvements, once implemented, will positively affect transportation for existing and future drivers as well as bicyclists and pedestrians. Funding arrangements should be considered on a fair-share basis as the substantial effects indicated are generally related to the exacerbation of operations estimated to be deficient prior to the addition of program-generated traffic volumes. The County may choose to require that projects directly fund the improvements, with reimbursements at later dates, or the County may choose to incorporate these improvements into the County's existing AB1600 development impact fee program.

#### *Intersection 4 – Old Redwood Highway/Fulton Road (Potential Sites LAR-1 through LAR-8)*

Old Redwood Highway/Fulton Road is a side-street stop-controlled intersection that operates unacceptably under Cumulative Conditions in both the AM and PM peak hours; the intersection meets the Peak Hour Signal Warrant under both the AM and PM peak hour. The improvement measure is for program-related development to fund the construction of a traffic signal or roundabout at the intersection. Construction of a signal would result in the intersection operating at LOS B conditions in both the AM and PM peak hours. Construction of a roundabout would result in LOS A operations in the AM peak hour and LOS D operations in the PM peak hour.

#### *Intersection 5 – Old Redwood Highway/Airport Boulevard (Potential Sites LAR-1 through LAR-8)*

Old Redwood Highway/Fulton Road is a signalized intersection that operates unacceptably under Cumulative Conditions in both the AM and PM peak hours; substantial intersection operations effects occur during the AM peak hour only. The improvement measure is for program-related development to fund periodic signal timing adjustments at the intersection. While the intersection operations would remain at an unacceptable LOS F, the signal timing adjustments would result in an average intersection delay value that is lower than the Cumulative (without Program Conditions) value (225.5 seconds of delay after retiming versus 230.4 seconds of delay under Cumulative Conditions). Major widening of the intersection would need to occur in order to return the intersection to acceptable (LOS D or better) operations.



#### Intersection 7 – Old Redwood Highway/Faught Road (Potential Sites LAR-1 through LAR-8)

Old Redwood Highway/Faught Road is a side-street stop-controlled intersection that operates unacceptably under Cumulative Conditions in both the AM and PM peak hours; the intersection meets the Peak Hour Signal Warrant under both the AM and PM peak hour. The improvement measure is for program-related development to fund the construction of a traffic signal at the intersection; a roundabout is not advised because the intersection is between two existing signalized intersections. Construction of a signal would result in the intersection operating at LOS D conditions in the AM peak hour and LOS C conditions in the PM peak hour.

#### Intersection 8 – Old Redwood Highway/Wikiup Drive-Mark West Commons Circle (Potential Sites LAR-1 through LAR-8)

Old Redwood Highway/Wikiup Drive-Mark West Commons Circle is a signalized intersection that operates unacceptably under Cumulative Conditions in the PM peak hour; substantial intersection operations effects occur during the PM peak hour only. The improvement measure is for program-related development to fund periodic signal timing adjustments at the intersection. Implementing signal timing adjustments would return PM peak hour operations to LOS D conditions.

#### Intersection 9 – Front Street (SR 116)/Mirabel Road (Potential Sites FOR-1 through FOR-6 and GUE-1 through GUE-4)

Front Street (SR 116)/Mirabel Road is a side-street stop-controlled intersection that operates unacceptably under Cumulative Conditions in both the AM and PM peak hours; the intersection meets the Peak Hour Signal Warrant under both the AM and PM peak hour. The improvement measure is for program-related development to fund the construction of a traffic signal or roundabout at the intersection. Construction of a signal would result in the intersection operating at LOS B conditions in both the AM and PM peak hours. Construction of a roundabout would result in LOS B operations in the AM peak hour and LOS B operations in the PM peak hour.

#### Intersection 11 – Todd Road/Moorland Avenue (Potential Sites SAN-1 through SAN-10)

Todd Road/Moorland Avenue is a side-street stop-controlled intersection that operates unacceptably under Cumulative Conditions in both the AM and PM peak hours; the intersection meets the Peak Hour Signal Warrant under both the AM and PM peak hour. The improvement measure is for program-related development to fund the construction of the following improvements:

- A traffic signal at the intersection, including protected left turns for eastbound and westbound Todd Road and split phases for the northbound and southbound movements
- Modify striping on westbound Todd Road to accommodate a left turn lane, a through lane, and a right turn lane



A roundabout is not advised because the intersection is located very near to an existing traffic signal. Construction of a signal and associate striping improvements would result in the intersection operating at LOS C conditions in the AM peak hour and LOS D in the PM peak hour.

#### Intersection 12 – Todd Road/South Moorland Avenue/US 101 Southbound Ramps (Potential Sites SAN-1 through SAN-10)

Todd Road/South Moorland Avenue/US 101 Southbound Ramps is a signalized intersection that operates unacceptably under Cumulative Conditions in both the AM and PM peak hours. The improvement measure is for program-related development to fund the following improvements:

- Modification of the traffic signal to include an eastbound right turn overlap phase
- Modification of striping on the northbound approach to include one left turn lane, one through-left turn shared lane, and one right turn lane
- Widening of westbound Todd Road leaving the intersection to accommodate two receiving lanes (would be consistent with mitigation measure proposed for Intersection 11)
- Updates to signal timing at intersection

Construction of the proposed improvements would result in LOS C operations in the AM peak hour and LOS D operations in the PM peak hour. Updates to signal timings may require corresponding updates at the nearby intersection of South Moorland Avenue/Todd Road Overcrossing.

#### Intersection 16 – Verano Avenue/Riverside Drive (Potential Sites AGU-1 through AGU-3)

Verano Avenue/Riverside Drive is a side-street stop-controlled intersection that operates unacceptably under Cumulative Conditions in both the AM and PM peak hours; the intersection meets the Peak Hour Signal Warrant in the PM peak hour only. The improvement measure is for program-related development to fund the construction of a slow-speed roundabout at the intersection. Construction of a roundabout would result in the intersection operating at LOS A conditions in the AM peak hour and LOS B conditions and PM peak hours.

#### Intersection 17 – Adobe Road/Petaluma Hill Road-Main Street (Potential Sites PEN-1 through PEN-9)

Adobe Road/Petaluma Hill Road-Main Street is a signalized intersection that operates unacceptably under Cumulative Conditions in both the AM and PM peak hours; substantial intersection operations effects occur during the AM peak hour only. The improvement measure is for program-related development to fund periodic signal timing adjustments at the intersection. While the intersection operations would remain at an unacceptable LOS F, the signal timing adjustments would result in an average intersection delay value that is lower than the Cumulative (without Program Conditions) value (104.8 seconds of delay after retiming versus 188.4 seconds



of delay under Cumulative Conditions). Major widening of the intersection would need to occur in order to return the intersection to acceptable (LOS D or better) operations.

#### Intersection 18 – Old Redwood Highway/Main Street (Potential Sites PEN-1 through PEN-9)

Old Redwood Highway/Main Street is a signalized intersection that operates unacceptably under Cumulative Conditions in the PM peak hour; substantial intersection operations effects occur during the PM peak hour only. The improvement measure is for program-related development to fund periodic signal timing adjustments at the intersection. Implementing signal timing adjustments would return PM peak hour operations to LOS D conditions.

## Conclusions

Results of the VMT analysis indicate that the program would result in significant and unavoidable impacts. Mitigation measures that could be added would likely not result in a substantial enough reduction of VMT needed to meet the threshold values.

The informational operational analysis results suggest that several improvement measures (to be funded on a fair share basis) should be constructed to reduce the program's effect to less-than-substantial levels. Improvement measures are designed with a longer-term horizon in mind, as development under the program is not anticipated to be built in the near-term.

This concludes the transportation assessment of the Sonoma Housing Rezone project transportation assessment. Please call Ian Barnes or Ashlee Takushi at (925) 930-7100 with any questions.

## Attachments

**Attachment A** Intersection Level of Service Definitions

**Attachment B** Volume Figures

**Attachment C** Synchro HCM 6<sup>th</sup> Edition Outputs

**Attachment D** Signal Warrant Analysis Worksheets

**ATTACHMENT A**

**VEHICLE LEVEL OF SERVICE DEFINITIONS**





**Table A1: Signalized Intersection Level of Service Definitions**

Level of Service	Description	Average Control Delay per Vehicle (seconds)
A	Operations with very low delay occurring with favorable progression and/or short cycle lengths.	≤ 10.0
B	Operations with low delay occurring with good progression and/or short cycle lengths.	10.1 to 20.0
C	Operations with average delays resulting from fair progression and/or longer cycle lengths. Individual cycle failures begin to appear.	20.1 to 35.0
D	Operations with longer delays due to a combination of unfavorable progression, long cycle lengths, and high volume-to-capacity (V/C) ratios. Many vehicles stop and individual cycle failures are noticeable.	35.1 to 55.0
E	Operations with high delay values indicating poor progression, long cycle lengths, and high V/C ratios. Individual cycle failures are frequent occurrences.	55.1 to 80.0
F	Operations with delays unacceptable to most drivers occurring due to over-saturation, poor progression, or very long cycle lengths.	> 80.0

Source: *Highway Capacity Manual, 6<sup>th</sup> Edition.*

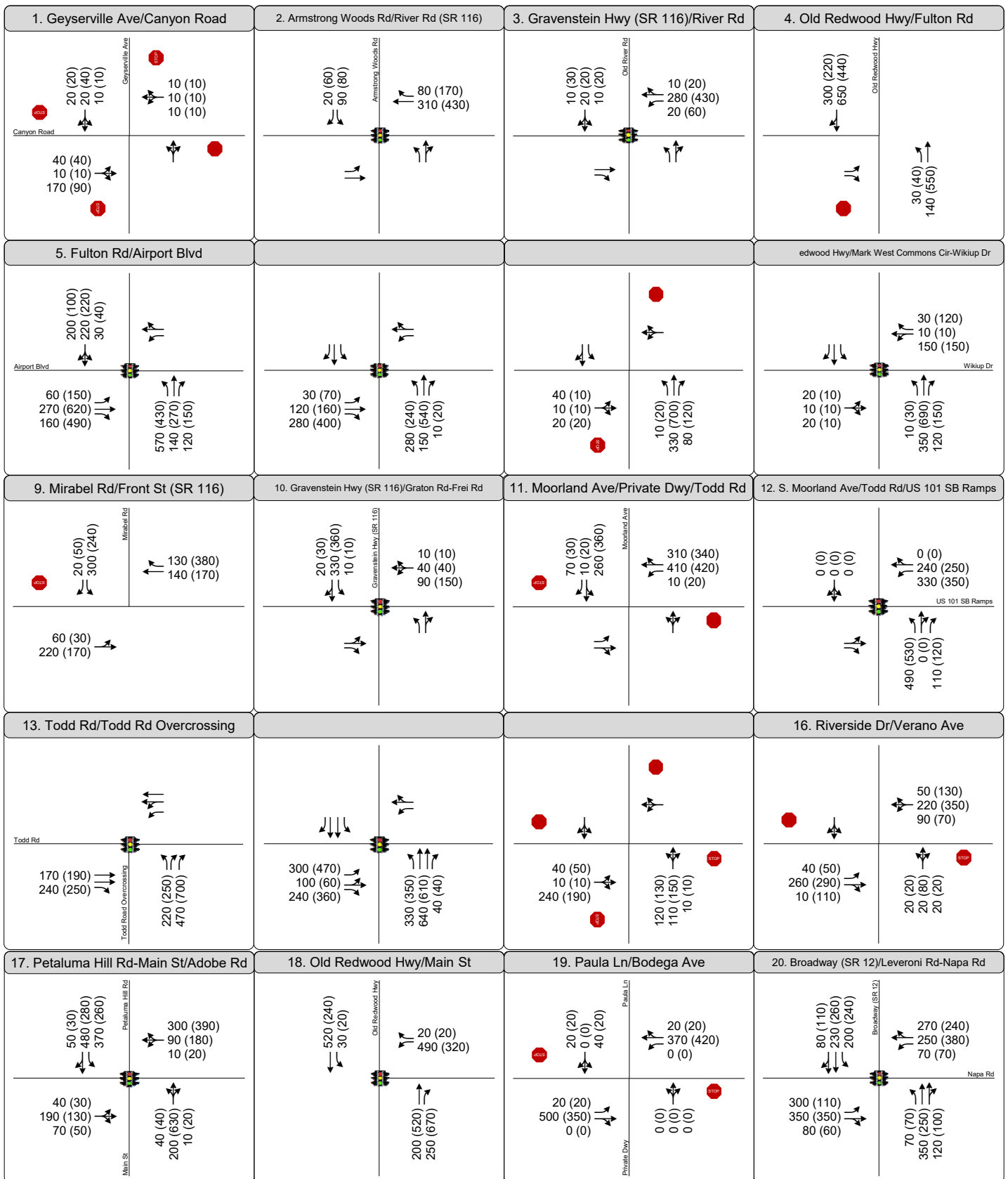
**Table A2: Unsignalized Intersection Level of Service Definitions**

Level of Service	Description	Average Control Delay per Vehicle (seconds)
A	Little or no delay.	≤ 10.0
B	Short traffic delays.	10.1 to 15.0
C	Average traffic delays.	15.1 to 25.0
D	Long traffic delays.	25.1 to 35.0
E	Very long traffic delays.	35.1 to 50.0
F	Extreme traffic delays with intersection capacity exceeded.	> 50.0

Source: *Highway Capacity Manual, 6<sup>th</sup> Edition.*

**ATTACHMENT B**  
**VOLUME FIGURES**





**Legend:**

XX (YY) = AM (PM) Peak hour Volumes

= Signalized Intersection

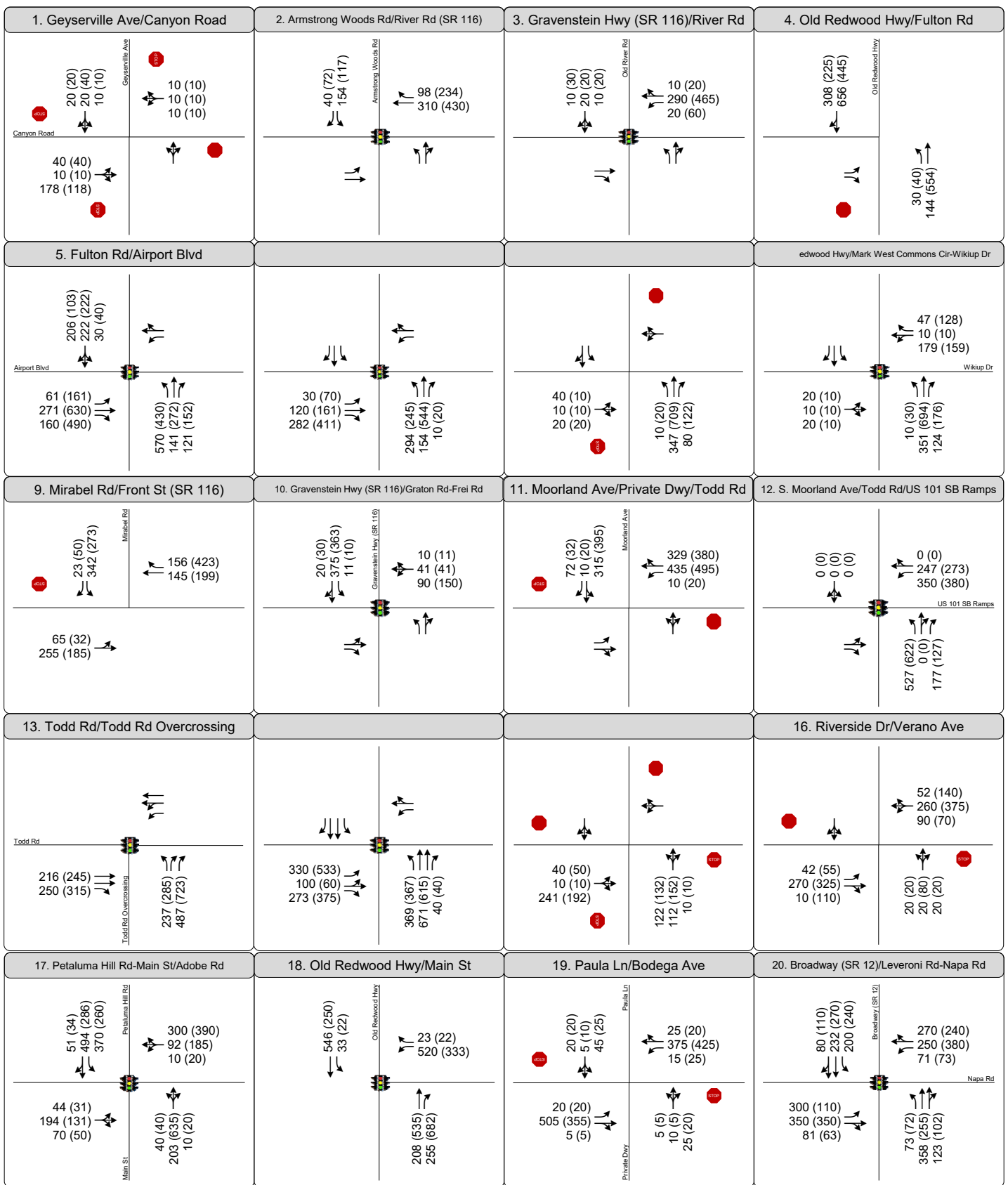
= Stop Sign on Approach



Figure 1

Existing Conditions (Year 2019)

Weekday Peak Hour Intersection Traffic Volumes, Lane Configurations, and Intersection Control Devices



**Legend:**

XX (YY) = AM (PM) Peak hour Volumes

= Signalized Intersection

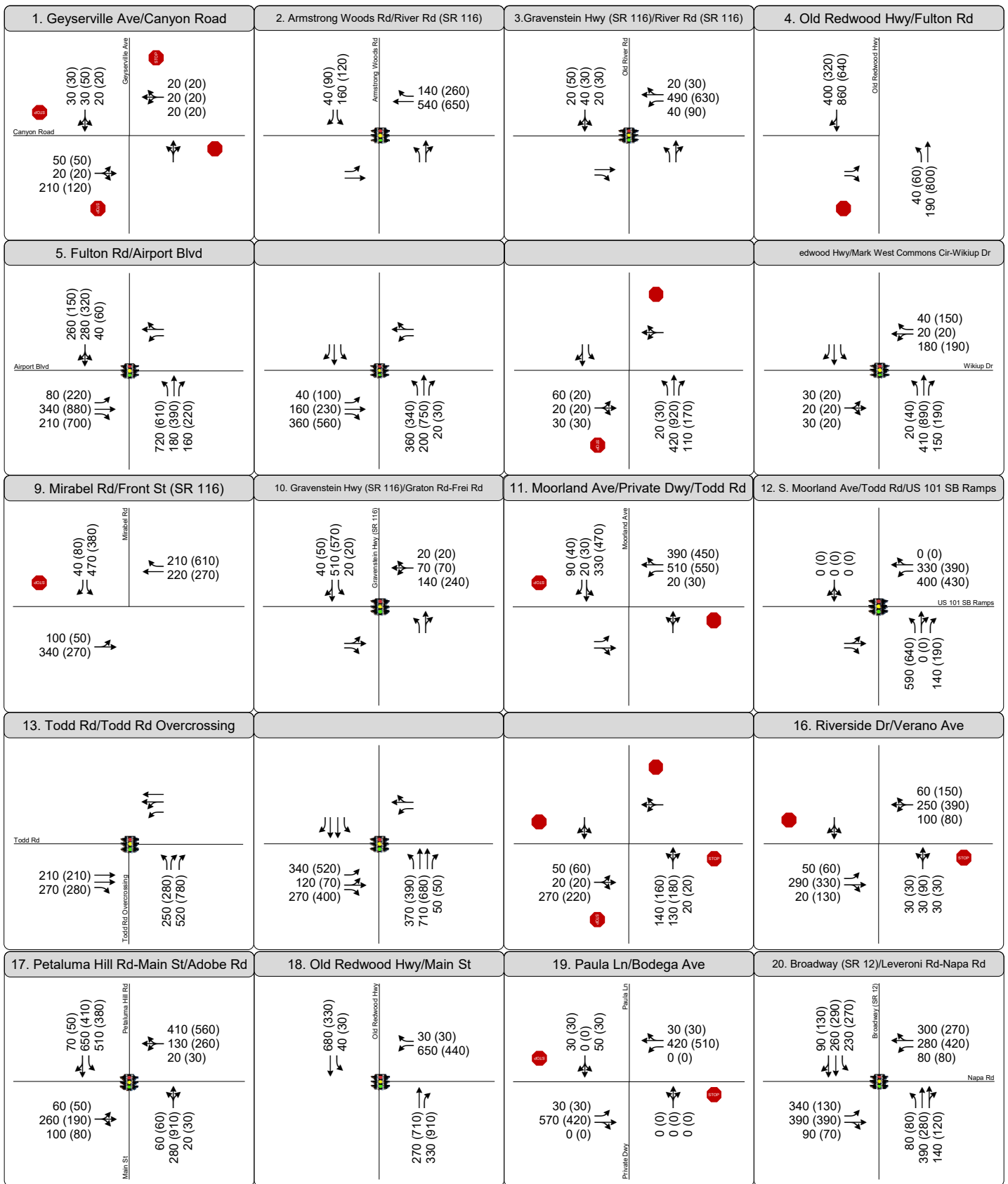
= Stop Sign on Approach

Figure 2

Existing plus Program Conditions

Weekday Peak Hour Intersection Traffic Volumes, Lane Configurations, and Intersection Control Devices





**Legend:**

XX (YY) = AM (PM) Peak hour Volumes

= Signalized Intersection

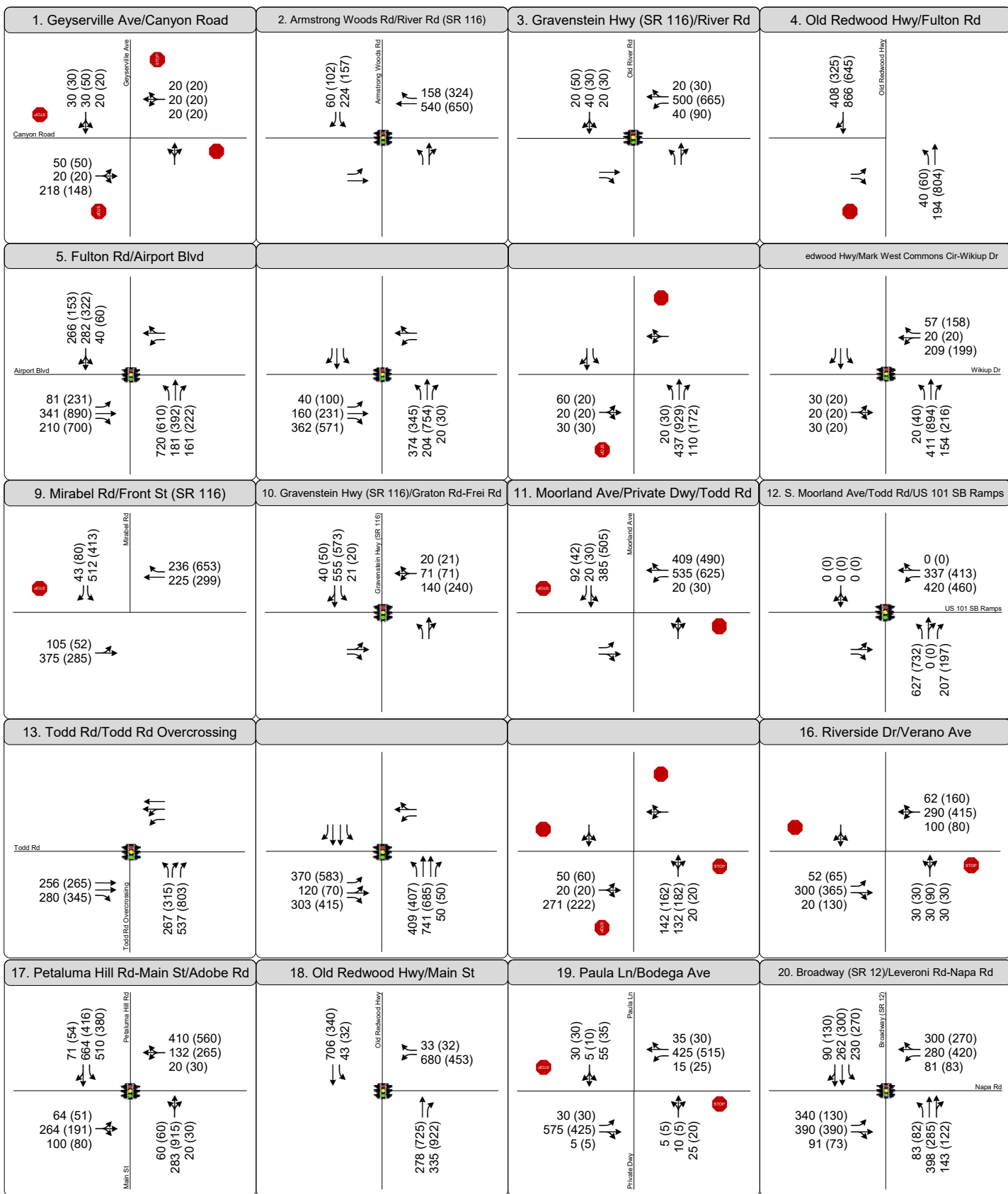
= Stop Sign on Approach

Figure 3

Cumulative Conditions (Year 2040)

Weekday Peak Hour Intersection Traffic Volumes,  
Lane Configurations, and Intersection Control Devices





**Legend:**

XX (YY) = AM (PM) Peak hour Volumes

= Signalized Intersection

= Stop Sign on Approach



Figure 4

Cumulative plus Program Conditions  
 Weekday Peak Hour Intersection Traffic Volumes,  
 Lane Configurations, and Intersection Control Devices

**ATTACHMENT C**

**SYNCHRO HCM 6<sup>TH</sup> EDITION OUTPUTS**



**ATTACHMENT C-1**

**EXISTING CONDITIONS (YEAR 2019) OUPUTS**





HCM 6th AWSC  
 1: Geyserville Ave & Canyon Road

Existing Conditions AM

Intersection	
Intersection Delay, s/veh	8.3
Intersection LOS	A

Movement	EBL	EBT	EBR	WBL	WBT	WBR	NBL	NBT	NBR	SBL	SBT	SBR
Lane Configurations		↕			↕			↕			↕	
Traffic Vol, veh/h	40	10	170	10	10	10	90	20	10	10	20	20
Future Vol, veh/h	40	10	170	10	10	10	90	20	10	10	20	20
Peak Hour Factor	0.92	0.92	0.92	0.92	0.92	0.92	0.92	0.92	0.92	0.92	0.92	0.92
Heavy Vehicles, %	2	2	2	2	2	2	2	2	2	2	2	2
Mvmt Flow	43	11	185	11	11	11	98	22	11	11	22	22
Number of Lanes	0	1	0	0	1	0	0	1	0	0	1	0

Approach	EB	WB	NB	SB
Opposing Approach	WB	EB	SB	NB
Opposing Lanes	1	1	1	1
Conflicting Approach Left	SB	NB	EB	WB
Conflicting Lanes Left	1	1	1	1
Conflicting Approach Right	NB	SB	WB	EB
Conflicting Lanes Right	1	1	1	1
HCM Control Delay	8.4	7.7	8.6	7.8
HCM LOS	A	A	A	A

Lane	NBLn1	EBLn1	WBLn1	SBLn1
Vol Left, %	75%	18%	33%	20%
Vol Thru, %	17%	5%	33%	40%
Vol Right, %	8%	77%	33%	40%
Sign Control	Stop	Stop	Stop	Stop
Traffic Vol by Lane	120	220	30	50
LT Vol	90	40	10	10
Through Vol	20	10	10	20
RT Vol	10	170	10	20
Lane Flow Rate	130	239	33	54
Geometry Grp	1	1	1	1
Degree of Util (X)	0.169	0.265	0.041	0.067
Departure Headway (Hd)	4.669	3.985	4.485	4.464
Convergence, Y/N	Yes	Yes	Yes	Yes
Cap	770	904	800	803
Service Time	2.692	1.998	2.506	2.49
HCM Lane V/C Ratio	0.169	0.264	0.041	0.067
HCM Control Delay	8.6	8.4	7.7	7.8
HCM Lane LOS	A	A	A	A
HCM 95th-tile Q	0.6	1.1	0.1	0.2

HCM 6th Signalized Intersection Summary  
 2: Armstrong Woods Rd & River Rd

Existing Conditions AM



Movement	EBL	EBT	EBR	WBL	WBT	WBR	NBL	NBT	NBR	SBL	SBT	SBR
Lane Configurations	↖	↗			↖	↗	↖	↗		↖	↗	
Traffic Volume (veh/h)	50	300	0	0	310	80	10	20	20	90	0	20
Future Volume (veh/h)	50	300	0	0	310	80	10	20	20	90	0	20
Initial Q (Qb), veh	0	0	0	0	0	0	0	0	0	0	0	0
Ped-Bike Adj(A_pbT)	1.00		1.00	1.00		0.99	0.99		0.99	0.99		0.99
Parking Bus, Adj	1.00	1.00	1.00	1.00	1.00	1.00	1.00	1.00	1.00	1.00	1.00	1.00
Work Zone On Approach	No				No				No			
Adj Sat Flow, veh/h/ln	1870	1870	0	0	1870	1870	1870	1870	1870	1870	1870	1870
Adj Flow Rate, veh/h	54	326	0	0	337	42	11	22	4	98	0	4
Peak Hour Factor	0.92	0.92	0.92	0.92	0.92	0.92	0.92	0.92	0.92	0.92	0.92	0.92
Percent Heavy Veh, %	2	2	0	0	2	2	2	2	2	2	2	2
Cap, veh/h	511	981	0	0	560	471	482	294	53	463	0	300
Arrive On Green	0.08	0.52	0.00	0.00	0.30	0.30	0.19	0.19	0.19	0.19	0.00	0.19
Sat Flow, veh/h	1781	1870	0	0	1870	1572	1394	1537	279	1368	0	1569
Grp Volume(v), veh/h	54	326	0	0	337	42	11	0	26	98	0	4
Grp Sat Flow(s),veh/h/ln	1781	1870	0	0	1870	1572	1394	0	1817	1368	0	1569
Q Serve(g_s), s	0.6	3.3	0.0	0.0	5.1	0.6	0.2	0.0	0.4	2.1	0.0	0.1
Cycle Q Clear(g_c), s	0.6	3.3	0.0	0.0	5.1	0.6	0.3	0.0	0.4	2.5	0.0	0.1
Prop In Lane	1.00		0.00	0.00		1.00	1.00		0.15	1.00		1.00
Lane Grp Cap(c), veh/h	511	981	0	0	560	471	482	0	348	463	0	300
V/C Ratio(X)	0.11	0.33	0.00	0.00	0.60	0.09	0.02	0.00	0.07	0.21	0.00	0.01
Avail Cap(c_a), veh/h	740	1809	0	0	2375	1996	973	0	989	946	0	854
HCM Platoon Ratio	1.00	1.00	1.00	1.00	1.00	1.00	1.00	1.00	1.00	1.00	1.00	1.00
Upstream Filter(I)	1.00	1.00	0.00	0.00	1.00	1.00	1.00	0.00	1.00	1.00	0.00	1.00
Uniform Delay (d), s/veh	6.1	4.5	0.0	0.0	9.9	8.3	11.0	0.0	11.0	12.0	0.0	10.8
Incr Delay (d2), s/veh	0.1	0.2	0.0	0.0	1.0	0.1	0.0	0.0	0.1	0.2	0.0	0.0
Initial Q Delay(d3),s/veh	0.0	0.0	0.0	0.0	0.0	0.0	0.0	0.0	0.0	0.0	0.0	0.0
%ile BackOfQ(50%),veh/ln	0.1	0.7	0.0	0.0	1.7	0.2	0.1	0.0	0.1	0.5	0.0	0.0
Unsig. Movement Delay, s/veh												
LnGrp Delay(d),s/veh	6.2	4.7	0.0	0.0	10.9	8.4	11.0	0.0	11.1	12.2	0.0	10.9
LnGrp LOS	A	A	A	A	B	A	B	A	B	B	A	B
Approach Vol, veh/h	380				379		37				102	
Approach Delay, s/veh	4.9				10.7		11.0				12.2	
Approach LOS	A				B		B				B	
Timer - Assigned Phs	2		4		5	6	8					
Phs Duration (G+Y+Rc), s	22.0		11.0		7.4	14.6	11.0					
Change Period (Y+Rc), s	* 4.7		* 4.7		* 4.7	* 4.7	* 4.7					
Max Green Setting (Gmax), s	* 32		* 18		* 7	* 42	* 18					
Max Q Clear Time (g_c+I1), s	5.3		4.5		2.6	7.1	2.4					
Green Ext Time (p_c), s	2.1		0.2		0.0	2.5	0.1					

Intersection Summary

HCM 6th Ctrl Delay	8.4
HCM 6th LOS	A

Notes

User approved pedestrian interval to be less than phase max green.  
 \* HCM 6th computational engine requires equal clearance times for the phases crossing the barrier.

# HCM 6th Signalized Intersection Summary

## 3: Gravenstein Hwy/Old River Rd & River Rd

Existing Conditions AM



Movement	EBL	EBT	EBR	WBL	WBT	WBR	NBL	NBT	NBR	SBL	SBT	SBR
Lane Configurations		↑	↗	↖	↗	↖	↗	↖			↕	
Traffic Volume (veh/h)	0	300	110	20	280	10	100	30	70	10	20	10
Future Volume (veh/h)	0	300	110	20	280	10	100	30	70	10	20	10
Initial Q (Qb), veh	0	0	0	0	0	0	0	0	0	0	0	0
Ped-Bike Adj(A_pbT)	1.00		0.99	1.00		0.99	0.99		1.00	1.00		0.99
Parking Bus, Adj	1.00	1.00	1.00	1.00	1.00	1.00	1.00	1.00	1.00	1.00	1.00	1.00
Work Zone On Approach		No			No			No			No	
Adj Sat Flow, veh/h/ln	0	1870	1870	1870	1870	1870	1870	1870	1870	1870	1870	1870
Adj Flow Rate, veh/h	0	326	68	22	304	10	109	33	17	11	22	2
Peak Hour Factor	0.92	0.92	0.92	0.92	0.92	0.92	0.92	0.92	0.92	0.92	0.92	0.92
Percent Heavy Veh, %	0	2	2	2	2	2	2	2	2	2	2	2
Cap, veh/h	0	577	485	462	895	29	528	262	135	206	303	22
Arrive On Green	0.00	0.31	0.31	0.05	0.50	0.50	0.22	0.22	0.22	0.22	0.22	0.22
Sat Flow, veh/h	0	1870	1572	1781	1800	59	1373	1163	599	293	1348	99
Grp Volume(v), veh/h	0	326	68	22	0	314	109	0	50	35	0	0
Grp Sat Flow(s),veh/h/ln	0	1870	1572	1781	0	1859	1373	0	1762	1740	0	0
Q Serve(g_s), s	0.0	4.9	1.1	0.2	0.0	3.5	1.6	0.0	0.8	0.0	0.0	0.0
Cycle Q Clear(g_c), s	0.0	4.9	1.1	0.2	0.0	3.5	2.1	0.0	0.8	0.5	0.0	0.0
Prop In Lane	0.00		1.00	1.00		0.03	1.00		0.34	0.31		0.06
Lane Grp Cap(c), veh/h	0	577	485	462	0	924	528	0	396	531	0	0
V/C Ratio(X)	0.00	0.57	0.14	0.05	0.00	0.34	0.21	0.00	0.13	0.07	0.00	0.00
Avail Cap(c_a), veh/h	0	1328	1116	847	0	1320	1437	0	1564	649	0	0
HCM Platoon Ratio	1.00	1.00	1.00	1.00	1.00	1.00	1.00	1.00	1.00	1.00	1.00	1.00
Upstream Filter(I)	0.00	1.00	1.00	1.00	0.00	1.00	1.00	0.00	1.00	1.00	0.00	0.00
Uniform Delay (d), s/veh	0.0	9.8	8.5	6.5	0.0	5.1	10.9	0.0	10.5	10.3	0.0	0.0
Incr Delay (d2), s/veh	0.0	0.9	0.1	0.0	0.0	0.2	0.2	0.0	0.1	0.1	0.0	0.0
Initial Q Delay(d3),s/veh	0.0	0.0	0.0	0.0	0.0	0.0	0.0	0.0	0.0	0.0	0.0	0.0
%ile BackOfQ(50%),veh/ln	0.0	1.7	0.3	0.1	0.0	0.8	0.6	0.0	0.3	0.2	0.0	0.0
Unsig. Movement Delay, s/veh												
LnGrp Delay(d),s/veh	0.0	10.7	8.6	6.6	0.0	5.4	11.1	0.0	10.6	10.4	0.0	0.0
LnGrp LOS		A	B	A	A	A	B	A	B	B	A	A
Approach Vol, veh/h		394			336			159			35	
Approach Delay, s/veh		10.3			5.4			11.0			10.4	
Approach LOS		B			A			B			B	
Timer - Assigned Phs	1	2	4		6		8					
Phs Duration (G+Y+Rc), s	6.4	15.1	12.3		21.5		12.3					
Change Period (Y+Rc), s	4.7	* 4.7	* 4.7		* 4.7		* 4.7					
Max Green Setting (Gmax), s	30	* 24	* 10		* 24		* 30					
Max Q Clear Time (g_c+1/2), s	12.2	6.9	2.5		5.5		4.1					
Green Ext Time (p_c), s	0.0	2.1	0.0		1.8		0.6					

### Intersection Summary

HCM 6th Ctrl Delay	8.7
HCM 6th LOS	A

### Notes

- User approved pedestrian interval to be less than phase max green.
- \* HCM 6th computational engine requires equal clearance times for the phases crossing the barrier.

HCM 6th TWSC  
4: Old Redwood Hwy & Fulton Rd

Existing Conditions AM

Intersection						
Int Delay, s/veh	3.6					
Movement	EBL	EBR	NBL	NBT	SBT	SBR
Lane Configurations	↖	↗	↖	↗	↗	↖
Traffic Vol, veh/h	130	30	30	140	650	300
Future Vol, veh/h	130	30	30	140	650	300
Conflicting Peds, #/hr	0	0	0	0	0	0
Sign Control	Stop	Stop	Free	Free	Free	Free
RT Channelized	-	Stop	-	None	-	None
Storage Length	0	90	70	-	-	100
Veh in Median Storage, #	0	-	-	0	0	-
Grade, %	0	-	-	0	0	-
Peak Hour Factor	92	92	92	92	92	92
Heavy Vehicles, %	2	2	2	2	2	2
Mvmt Flow	141	33	33	152	707	326























Major/Minor	Minor2	Major1	Major2			
Conflicting Flow All	925	707	1033	0	-	0
Stage 1	707	-	-	-	-	-
Stage 2	218	-	-	-	-	-
Critical Hdwy	6.42	6.22	4.12	-	-	-
Critical Hdwy Stg 1	5.42	-	-	-	-	-
Critical Hdwy Stg 2	5.42	-	-	-	-	-
Follow-up Hdwy	3.518	3.318	2.218	-	-	-
Pot Cap-1 Maneuver	299	435	673	-	-	-
Stage 1	489	-	-	-	-	-
Stage 2	818	-	-	-	-	-
Platoon blocked, %				-	-	-
Mov Cap-1 Maneuver	284	435	673	-	-	-
Mov Cap-2 Maneuver	284	-	-	-	-	-
Stage 1	465	-	-	-	-	-
Stage 2	818	-	-	-	-	-

Approach	EB	NB	SB
HCM Control Delay, s	26.7	1.9	0
HCM LOS	D		

Minor Lane/Major Mvmt	NBL	NBT	EBLn1	EBLn2	SBT	SBR
Capacity (veh/h)	673	-	284	435	-	-
HCM Lane V/C Ratio	0.048	-	0.498	0.075	-	-
HCM Control Delay (s)	10.6	-	29.6	13.9	-	-
HCM Lane LOS	B	-	D	B	-	-
HCM 95th %tile Q(veh)	0.2	-	2.6	0.2	-	-

HCM 6th Signalized Intersection Summary  
5: Fulton Rd & Airport Blvd

Existing Conditions AM

												
Movement	EBL	EBT	EBR	WBL	WBT	WBR	NBL	NBT	NBR	SBL	SBT	SBR
Lane Configurations												
Traffic Volume (veh/h)	60	270	160	180	480	20	570	140	120	30	220	200
Future Volume (veh/h)	60	270	160	180	480	20	570	140	120	30	220	200
Initial Q (Qb), veh	0	0	0	0	0	0	0	0	0	0	0	0
Ped-Bike Adj(A_pbT)	1.00		0.99	1.00		0.99	1.00		0.99	1.00		0.99
Parking Bus, Adj	1.00	1.00	1.00	1.00	1.00	1.00	1.00	1.00	1.00	1.00	1.00	1.00
Work Zone On Approach		No			No			No			No	
Adj Sat Flow, veh/h/ln	1870	1870	1870	1870	1870	1870	1870	1870	1870	1870	1870	1870
Adj Flow Rate, veh/h	65	293	38	196	522	21	620	152	34	33	239	194
Peak Hour Factor	0.92	0.92	0.92	0.92	0.92	0.92	0.92	0.92	0.92	0.92	0.92	0.92
Percent Heavy Veh, %	2	2	2	2	2	2	2	2	2	2	2	2
Cap, veh/h	84	378	316	227	497	20	496	521	437	23	164	133
Arrive On Green	0.05	0.20	0.20	0.13	0.28	0.28	0.28	0.28	0.28	0.19	0.19	0.19
Sat Flow, veh/h	1781	1870	1565	1781	1785	72	1781	1870	1571	122	886	719
Grp Volume(v), veh/h	65	293	38	196	0	543	620	152	34	466	0	0
Grp Sat Flow(s),veh/h/ln	1781	1870	1565	1781	0	1857	1781	1870	1571	1728	0	0
Q Serve(g_s), s	3.9	16.0	2.1	11.6	0.0	30.0	30.0	6.9	1.7	20.0	0.0	0.0
Cycle Q Clear(g_c), s	3.9	16.0	2.1	11.6	0.0	30.0	30.0	6.9	1.7	20.0	0.0	0.0
Prop In Lane	1.00		1.00	1.00		0.04	1.00		1.00	0.07		0.42
Lane Grp Cap(c), veh/h	84	378	316	227	0	517	496	521	437	321	0	0
V/C Ratio(X)	0.77	0.78	0.12	0.86	0.00	1.05	1.25	0.29	0.08	1.45	0.00	0.00
Avail Cap(c_a), veh/h	331	521	436	331	0	517	496	521	437	321	0	0
HCM Platoon Ratio	1.00	1.00	1.00	1.00	1.00	1.00	1.00	1.00	1.00	1.00	1.00	1.00
Upstream Filter(I)	1.00	1.00	1.00	1.00	0.00	1.00	1.00	1.00	1.00	1.00	0.00	0.00
Uniform Delay (d), s/veh	50.8	40.7	35.2	46.1	0.0	38.9	38.9	30.6	28.7	43.9	0.0	0.0
Incr Delay (d2), s/veh	5.6	3.1	0.1	10.8	0.0	53.6	128.6	0.1	0.0	220.7	0.0	0.0
Initial Q Delay(d3),s/veh	0.0	0.0	0.0	0.0	0.0	0.0	0.0	0.0	0.0	0.0	0.0	0.0
%ile BackOfQ(50%),veh/ln	1.8	7.4	0.8	5.7	0.0	20.8	30.1	3.0	0.6	28.0	0.0	0.0
Unsig. Movement Delay, s/veh												
LnGrp Delay(d),s/veh	56.3	43.8	35.2	56.9	0.0	92.5	167.5	30.7	28.7	264.6	0.0	0.0
LnGrp LOS	E	D	D	E	A	F	F	C	C	F	A	A
Approach Vol, veh/h		396			739			806			466	
Approach Delay, s/veh		45.1			83.0			135.9			264.6	
Approach LOS		D			F			F			F	
Timer - Assigned Phs	1	2		4	5	6		8				
Phs Duration (G+Y+Rc), s	19.1	27.8		25.1	10.9	36.0		35.8				
Change Period (Y+Rc), s	5.4	6.0		5.1	5.8	6.0		5.8				
Max Green Setting (Gmax), s	20.0	30.0		20.0	20.0	30.0		30.0				
Max Q Clear Time (g_c+I1), s	13.6	18.0		22.0	5.9	32.0		32.0				
Green Ext Time (p_c), s	0.1	0.8		0.0	0.0	0.0		0.0				
<b>Intersection Summary</b>												
HCM 6th Ctrl Delay	129.6											
HCM 6th LOS	F											
<b>Notes</b>												
User approved pedestrian interval to be less than phase max green.												

HCM 6th Signalized Intersection Summary  
6: Old Redwood Hwy & Airport Blvd

Existing Conditions AM



Movement	EBL	EBT	EBR	WBL	WBT	WBR	NBL	NBT	NBR	SBL	SBT	SBR
Lane Configurations												
Traffic Volume (veh/h)	30	120	280	30	240	30	280	150	10	30	660	60
Future Volume (veh/h)	30	120	280	30	240	30	280	150	10	30	660	60
Initial Q (Qb), veh	0	0	0	0	0	0	0	0	0	0	0	0
Ped-Bike Adj(A_pbT)	1.00		0.99	1.00		0.99	1.00		1.00	1.00		0.99
Parking Bus, Adj	1.00	1.00	1.00	1.00	1.00	1.00	1.00	1.00	1.00	1.00	1.00	1.00
Work Zone On Approach		No			No			No			No	
Adj Sat Flow, veh/h/ln	1870	1870	1870	1870	1870	1870	1870	1870	1870	1870	1870	1870
Adj Flow Rate, veh/h	33	130	57	33	261	28	304	163	6	33	717	23
Peak Hour Factor	0.92	0.92	0.92	0.92	0.92	0.92	0.92	0.92	0.92	0.92	0.92	0.92
Percent Heavy Veh, %	2	2	2	2	2	2	2	2	2	2	2	2
Cap, veh/h	45	369	309	45	312	33	339	965	813	45	656	552
Arrive On Green	0.03	0.20	0.20	0.03	0.19	0.19	0.19	0.52	0.52	0.03	0.35	0.35
Sat Flow, veh/h	1781	1870	1565	1781	1659	178	1781	1870	1577	1781	1870	1574
Grp Volume(v), veh/h	33	130	57	33	0	289	304	163	6	33	717	23
Grp Sat Flow(s),veh/h/ln	1781	1870	1565	1781	0	1837	1781	1870	1577	1781	1870	1574
Q Serve(g_s), s	1.6	5.1	2.6	1.6	0.0	13.0	14.3	4.0	0.2	1.6	30.0	0.8
Cycle Q Clear(g_c), s	1.6	5.1	2.6	1.6	0.0	13.0	14.3	4.0	0.2	1.6	30.0	0.8
Prop In Lane	1.00		1.00	1.00		0.10	1.00		1.00	1.00		1.00
Lane Grp Cap(c), veh/h	45	369	309	45	0	345	339	965	813	45	656	552
V/C Ratio(X)	0.73	0.35	0.18	0.73	0.00	0.84	0.90	0.17	0.01	0.73	1.09	0.04
Avail Cap(c_a), veh/h	250	874	732	250	0	558	416	965	813	208	656	552
HCM Platoon Ratio	1.00	1.00	1.00	1.00	1.00	1.00	1.00	1.00	1.00	1.00	1.00	1.00
Upstream Filter(I)	1.00	1.00	1.00	1.00	0.00	1.00	1.00	1.00	1.00	1.00	1.00	1.00
Uniform Delay (d), s/veh	41.4	29.6	28.6	41.4	0.0	33.5	33.8	11.0	10.1	41.4	27.8	18.3
Incr Delay (d2), s/veh	8.0	0.2	0.1	8.1	0.0	2.9	16.9	0.0	0.0	8.0	63.4	0.0
Initial Q Delay(d3),s/veh	0.0	0.0	0.0	0.0	0.0	0.0	0.0	0.0	0.0	0.0	0.0	0.0
%ile BackOfQ(50%),veh/ln	0.8	2.2	1.0	0.8	0.0	6.0	7.5	1.5	0.1	0.8	24.0	0.3
Unsig. Movement Delay, s/veh												
LnGrp Delay(d),s/veh	49.4	29.8	28.7	49.5	0.0	36.4	50.7	11.0	10.1	49.4	91.2	18.3
LnGrp LOS	D	C	C	D	A	D	D	B	B	D	F	B
Approach Vol, veh/h		220			322			473			773	
Approach Delay, s/veh		32.5			37.7			36.5			87.2	
Approach LOS		C			D			D			F	
Timer - Assigned Phs	1	2	3	4	5	6	7	8				
Phs Duration (G+Y+Rc), s	6.8	22.3	21.4	35.1	7.6	21.5	7.3	49.2				
Change Period (Y+Rc), s	4.6	5.4	5.1	5.1	5.4	* 5.4	5.1	5.1				
Max Green Setting (Gmax)	12.0	40.0	20.0	30.0	12.0	* 26	10.0	30.0				
Max Q Clear Time (g_c+1)	13.6	7.1	16.3	32.0	3.6	15.0	3.6	6.0				
Green Ext Time (p_c), s	0.0	0.2	0.1	0.0	0.0	0.5	0.0	0.3				

Intersection Summary

HCM 6th Ctrl Delay	58.2
HCM 6th LOS	E

Notes

- User approved pedestrian interval to be less than phase max green.
- \* HCM 6th computational engine requires equal clearance times for the phases crossing the barrier.

Intersection												
Int Delay, s/veh	41.5											
Movement	EBL	EBT	EBR	WBL	WBT	WBR	NBL	NBT	NBR	SBL	SBT	SBR
Lane Configurations		↕			↕		↗	↖	↗		↕	
Traffic Vol, veh/h	40	10	20	140	10	10	10	330	80	20	850	20
Future Vol, veh/h	40	10	20	140	10	10	10	330	80	20	850	20
Conflicting Peds, #/hr	0	0	0	0	0	0	0	0	0	0	0	0
Sign Control	Stop	Stop	Stop	Stop	Stop	Stop	Free	Free	Free	Free	Free	Free
RT Channelized	-	-	None	-	-	None	-	-	None	-	-	None
Storage Length	-	-	-	-	-	-	50	-	270	-	-	-
Veh in Median Storage, #	-	0	-	-	0	-	-	0	-	-	0	-
Grade, %	-	0	-	-	0	-	-	0	-	-	0	-
Peak Hour Factor	92	92	92	92	92	92	92	92	92	92	92	92
Heavy Vehicles, %	2	2	2	2	2	2	2	2	2	2	2	2
Mvmt Flow	43	11	22	152	11	11	11	359	87	22	924	22

Major/Minor	Minor2		Minor1		Major1		Major2					
Conflicting Flow All	1415	1447	935	1377	1371	359	946	0	0	446	0	0
Stage 1	979	979	-	381	381	-	-	-	-	-	-	-
Stage 2	436	468	-	996	990	-	-	-	-	-	-	-
Critical Hdwy	7.12	6.52	6.22	7.12	6.52	6.22	4.12	-	-	4.12	-	-
Critical Hdwy Stg 1	6.12	5.52	-	6.12	5.52	-	-	-	-	-	-	-
Critical Hdwy Stg 2	6.12	5.52	-	6.12	5.52	-	-	-	-	-	-	-
Follow-up Hdwy	3.518	4.018	3.318	3.518	4.018	3.318	2.218	-	-	2.218	-	-
Pot Cap-1 Maneuver	115	131	322	~ 122	146	685	725	-	-	1114	-	-
Stage 1	301	328	-	641	613	-	-	-	-	-	-	-
Stage 2	599	561	-	294	324	-	-	-	-	-	-	-
Platoon blocked, %								-	-	-	-	-
Mov Cap-1 Maneuver	102	124	322	~ 102	138	685	725	-	-	1114	-	-
Mov Cap-2 Maneuver	102	124	-	~ 102	138	-	-	-	-	-	-	-
Stage 1	296	314	-	631	604	-	-	-	-	-	-	-
Stage 2	570	553	-	254	310	-	-	-	-	-	-	-






















Approach	EB	WB	NB	SB
HCM Control Delay, s	65	\$ 369.4	0.2	0.2
HCM LOS	F	F		

Minor Lane/Major Mvmt	NBL	NBT	NBR	EBLn1	WBLn1	SBL	SBT	SBR
Capacity (veh/h)	725	-	-	131	110	1114	-	-
HCM Lane V/C Ratio	0.015	-	-	0.581	1.581	0.02	-	-
HCM Control Delay (s)	10	-	-	65	\$ 369.4	8.3	0	-
HCM Lane LOS	B	-	-	F	F	A	A	-
HCM 95th %tile Q(veh)	0	-	-	2.9	13	0.1	-	-

Notes  
 ~: Volume exceeds capacity    \$: Delay exceeds 300s    +: Computation Not Defined    \*: All major volume in platoon

HCM 6th Signalized Intersection Summary  
 8: Old Redwood Hwy & Mark West Commons Cir/Wikiup Dr

Existing Conditions AM

												
Movement	EBL	EBT	EBR	WBL	WBT	WBR	NBL	NBT	NBR	SBL	SBT	SBR
Lane Configurations												
Traffic Volume (veh/h)	20	10	20	150	10	30	10	350	120	150	790	10
Future Volume (veh/h)	20	10	20	150	10	30	10	350	120	150	790	10
Initial Q (Qb), veh	0	0	0	0	0	0	0	0	0	0	0	0
Ped-Bike Adj(A_pbT)	0.99		0.98	0.99		0.98	1.00		0.99	1.00		1.00
Parking Bus, Adj	1.00	1.00	1.00	1.00	1.00	1.00	1.00	1.00	1.00	1.00	1.00	1.00
Work Zone On Approach		No			No			No			No	
Adj Sat Flow, veh/h/ln	1870	1870	1870	1870	1870	1870	1870	1870	1870	1870	1870	1870
Adj Flow Rate, veh/h	22	11	5	163	11	7	11	380	53	163	859	6
Peak Hour Factor	0.92	0.92	0.92	0.92	0.92	0.92	0.92	0.92	0.92	0.92	0.92	0.92
Percent Heavy Veh, %	2	2	2	2	2	2	2	2	2	2	2	2
Cap, veh/h	170	71	18	376	15	248	20	754	635	209	951	802
Arrive On Green	0.16	0.16	0.16	0.16	0.16	0.16	0.01	0.40	0.40	0.12	0.51	0.51
Sat Flow, veh/h	293	447	112	1411	95	1560	1781	1870	1575	1781	1870	1577
Grp Volume(v), veh/h	38	0	0	174	0	7	11	380	53	163	859	6
Grp Sat Flow(s),veh/h/ln	853	0	0	1506	0	1560	1781	1870	1575	1781	1870	1577
Q Serve(g_s), s	0.1	0.0	0.0	0.0	0.0	0.2	0.3	7.0	1.0	4.1	19.3	0.1
Cycle Q Clear(g_c), s	5.0	0.0	0.0	4.9	0.0	0.2	0.3	7.0	1.0	4.1	19.3	0.1
Prop In Lane	0.58		0.13	0.94		1.00	1.00		1.00	1.00		1.00
Lane Grp Cap(c), veh/h	259	0	0	391	0	248	20	754	635	209	951	802
V/C Ratio(X)	0.15	0.00	0.00	0.45	0.00	0.03	0.54	0.50	0.08	0.78	0.90	0.01
Avail Cap(c_a), veh/h	412	0	0	929	0	846	463	1216	1024	463	1216	1026
HCM Platoon Ratio	1.00	1.00	1.00	1.00	1.00	1.00	1.00	1.00	1.00	1.00	1.00	1.00
Upstream Filter(I)	1.00	0.00	0.00	1.00	0.00	1.00	1.00	1.00	1.00	1.00	1.00	1.00
Uniform Delay (d), s/veh	16.8	0.0	0.0	18.4	0.0	16.4	22.7	10.3	8.5	19.8	10.3	5.6
Incr Delay (d2), s/veh	0.1	0.0	0.0	0.3	0.0	0.0	8.1	0.2	0.0	2.4	7.0	0.0
Initial Q Delay(d3),s/veh	0.0	0.0	0.0	0.0	0.0	0.0	0.0	0.0	0.0	0.0	0.0	0.0
%ile BackOfQ(50%),veh/ln	0.3	0.0	0.0	1.6	0.0	0.1	0.2	2.2	0.3	1.6	6.9	0.0
Unsig. Movement Delay, s/veh												
LnGrp Delay(d),s/veh	16.9	0.0	0.0	18.7	0.0	16.4	30.8	10.5	8.5	22.2	17.3	5.6
LnGrp LOS	B	A	A	B	A	B	C	B	A	C	B	A
Approach Vol, veh/h		38			181			444			1028	
Approach Delay, s/veh		16.9			18.6			10.8			18.0	
Approach LOS		B			B			B			B	
Timer - Assigned Phs		2	3	4		6	7	8				
Phs Duration (G+Y+Rc), s		11.9	5.6	28.6		11.9	10.5	23.7				
Change Period (Y+Rc), s		4.6	5.1	5.1		4.6	5.1	5.1				
Max Green Setting (Gmax), s		12.0	12.0	30.0		25.0	12.0	30.0				
Max Q Clear Time (g_c+I1), s		7.0	2.3	21.3		6.9	6.1	9.0				
Green Ext Time (p_c), s		0.0	0.0	2.2		0.6	0.1	1.1				
<b>Intersection Summary</b>												
HCM 6th Ctrl Delay			16.1									
HCM 6th LOS			B									
<b>Notes</b>												
User approved pedestrian interval to be less than phase max green.												



Intersection						
Int Delay, s/veh	9.7					
Movement	EBL	EBT	WBT	WBR	SBL	SBR
Lane Configurations		↕	↑	↗	↖	↗
Traffic Vol, veh/h	60	220	140	130	300	20
Future Vol, veh/h	60	220	140	130	300	20
Conflicting Peds, #/hr	0	0	0	0	0	0
Sign Control	Free	Free	Free	Free	Stop	Stop
RT Channelized	-	None	-	Yield	-	None
Storage Length	-	-	-	150	90	0
Veh in Median Storage, #	-	0	0	-	0	-
Grade, %	-	0	0	-	0	-
Peak Hour Factor	92	92	92	92	92	92
Heavy Vehicles, %	2	2	2	2	2	2
Mvmt Flow	65	239	152	141	326	22




















Major/Minor	Major1	Major2	Minor2		
Conflicting Flow All	152	0	-	0	521 152
Stage 1	-	-	-	-	152 -
Stage 2	-	-	-	-	369 -
Critical Hdwy	4.12	-	-	-	6.42 6.22
Critical Hdwy Stg 1	-	-	-	-	5.42 -
Critical Hdwy Stg 2	-	-	-	-	5.42 -
Follow-up Hdwy	2.218	-	-	-	3.518 3.318
Pot Cap-1 Maneuver	1429	-	-	-	516 894
Stage 1	-	-	-	-	876 -
Stage 2	-	-	-	-	699 -
Platoon blocked, %		-	-	-	
Mov Cap-1 Maneuver	1429	-	-	-	489 894
Mov Cap-2 Maneuver	-	-	-	-	489 -
Stage 1	-	-	-	-	830 -
Stage 2	-	-	-	-	699 -

Approach	EB	WB	SB
HCM Control Delay, s	1.6	0	24.9
HCM LOS			C

Minor Lane/Major Mvmt	EBL	EBT	WBT	WBR	SBLn1	SBLn2
Capacity (veh/h)	1429	-	-	-	489	894
HCM Lane V/C Ratio	0.046	-	-	-	0.667	0.024
HCM Control Delay (s)	7.6	0	-	-	25.9	9.1
HCM Lane LOS	A	A	-	-	D	A
HCM 95th %tile Q(veh)	0.1	-	-	-	4.9	0.1

HCM 6th Signalized Intersection Summary  
 10: Gravenstein Hwy & Graton Rd/Frei Rd

Existing Conditions AM

												
Movement	EBL	EBT	EBR	WBL	WBT	WBR	NBL	NBT	NBR	SBL	SBT	SBR
Lane Configurations												
Traffic Volume (veh/h)	30	50	110	90	40	10	70	290	110	10	330	20
Future Volume (veh/h)	30	50	110	90	40	10	70	290	110	10	330	20
Initial Q (Qb), veh	0	0	0	0	0	0	0	0	0	0	0	0
Ped-Bike Adj(A_pbT)	0.99		0.99	0.99		0.99	1.00		0.99	1.00		0.99
Parking Bus, Adj	1.00	1.00	1.00	1.00	1.00	1.00	1.00	1.00	1.00	1.00	1.00	1.00
Work Zone On Approach		No			No			No			No	
Adj Sat Flow, veh/h/ln	1870	1870	1870	1870	1870	1870	1870	1870	1870	1870	1870	1870
Adj Flow Rate, veh/h	33	54	29	98	43	9	76	315	113	11	359	20
Peak Hour Factor	0.92	0.92	0.92	0.92	0.92	0.92	0.92	0.92	0.92	0.92	0.92	0.92
Percent Heavy Veh, %	2	2	2	2	2	2	2	2	2	2	2	2
Cap, veh/h	209	290	359	305	118	19	284	531	191	61	491	27
Arrive On Green	0.23	0.23	0.23	0.23	0.23	0.23	0.16	0.41	0.41	0.03	0.28	0.28
Sat Flow, veh/h	459	1268	1568	788	513	83	1781	1312	471	1781	1754	98
Grp Volume(v), veh/h	87	0	29	150	0	0	76	0	428	11	0	379
Grp Sat Flow(s),veh/h/ln	1727	0	1568	1385	0	0	1781	0	1782	1781	0	1852
Q Serve(g_s), s	0.0	0.0	0.7	3.0	0.0	0.0	1.8	0.0	9.0	0.3	0.0	8.9
Cycle Q Clear(g_c), s	1.8	0.0	0.7	4.8	0.0	0.0	1.8	0.0	9.0	0.3	0.0	8.9
Prop In Lane	0.38		1.00	0.65		0.06	1.00		0.26	1.00		0.05
Lane Grp Cap(c), veh/h	499	0	359	441	0	0	284	0	722	61	0	518
V/C Ratio(X)	0.17	0.00	0.08	0.34	0.00	0.00	0.27	0.00	0.59	0.18	0.00	0.73
Avail Cap(c_a), veh/h	1824	0	1635	592	0	0	595	0	1859	1858	0	966
HCM Platoon Ratio	1.00	1.00	1.00	1.00	1.00	1.00	1.00	1.00	1.00	1.00	1.00	1.00
Upstream Filter(I)	1.00	0.00	1.00	1.00	0.00	0.00	1.00	0.00	1.00	1.00	0.00	1.00
Uniform Delay (d), s/veh	14.9	0.0	14.5	16.1	0.0	0.0	17.7	0.0	11.2	22.5	0.0	15.6
Incr Delay (d2), s/veh	0.2	0.0	0.1	0.5	0.0	0.0	0.5	0.0	0.8	1.4	0.0	2.0
Initial Q Delay(d3),s/veh	0.0	0.0	0.0	0.0	0.0	0.0	0.0	0.0	0.0	0.0	0.0	0.0
%ile BackOfQ(50%),veh/ln	0.7	0.0	0.2	1.2	0.0	0.0	0.6	0.0	2.6	0.1	0.0	3.2
Unsig. Movement Delay, s/veh												
LnGrp Delay(d),s/veh	15.1	0.0	14.6	16.6	0.0	0.0	18.2	0.0	11.9	23.9	0.0	17.6
LnGrp LOS	B	A	B	B	A	A	B	A	B	C	A	B
Approach Vol, veh/h		116			150			504			390	
Approach Delay, s/veh		15.0			16.6			12.9			17.8	
Approach LOS		B			B			B			B	
Timer - Assigned Phs	1	2		4	5	6		8				
Phs Duration (G+Y+Rc), s	12.3	19.2		16.4	6.3	25.2		16.4				
Change Period (Y+Rc), s	* 4.7	5.8		5.4	* 4.7	5.8		5.4				
Max Green Setting (Gmax), s	* 16	25.0		16.0	* 50	50.0		50.0				
Max Q Clear Time (g_c+I1), s	3.8	10.9		6.8	2.3	11.0		3.8				
Green Ext Time (p_c), s	0.1	1.7		0.4	0.0	2.7		0.6				

Intersection Summary

HCM 6th Ctrl Delay	15.2
HCM 6th LOS	B

Notes

- User approved pedestrian interval to be less than phase max green.
- \* HCM 6th computational engine requires equal clearance times for the phases crossing the barrier.

HCM 6th TWSC  
 11: Private Dwy/Moorland Ave & Todd Rd

Existing Conditions AM

Intersection												
Int Delay, s/veh	87.9											
Movement	EBL	EBT	EBR	WBL	WBT	WBR	NBL	NBT	NBR	SBL	SBT	SBR
Lane Configurations	↖	↗		↖	↗			↕			↖	↗
Traffic Vol, veh/h	50	360	10	10	410	310	10	10	10	260	10	70
Future Vol, veh/h	50	360	10	10	410	310	10	10	10	260	10	70
Conflicting Peds, #/hr	0	0	0	0	0	0	0	0	0	0	0	0
Sign Control	Free	Free	Free	Free	Free	Free	Stop	Stop	Stop	Stop	Stop	Stop
RT Channelized	-	-	None	-	-	None	-	-	None	-	-	None
Storage Length	100	-	-	70	-	-	-	-	-	-	-	60
Veh in Median Storage, #	-	0	-	-	0	-	-	0	-	-	0	-
Grade, %	-	0	-	-	0	-	-	0	-	-	0	-
Peak Hour Factor	92	92	92	92	92	92	92	92	92	92	92	92
Heavy Vehicles, %	2	2	2	2	2	2	2	2	2	2	2	2
Mvmt Flow	54	391	11	11	446	337	11	11	11	283	11	76

Major/Minor	Major1			Major2			Minor1			Minor2		
Conflicting Flow All	783	0	0	402	0	0	1185	1310	397	1153	1147	615
Stage 1	-	-	-	-	-	-	505	505	-	637	637	-
Stage 2	-	-	-	-	-	-	680	805	-	516	510	-
Critical Hdwy	4.12	-	-	4.12	-	-	7.12	6.52	6.22	7.12	6.52	6.22
Critical Hdwy Stg 1	-	-	-	-	-	-	6.12	5.52	-	6.12	5.52	-
Critical Hdwy Stg 2	-	-	-	-	-	-	6.12	5.52	-	6.12	5.52	-
Follow-up Hdwy	2.218	-	-	2.218	-	-	3.518	4.018	3.318	3.518	4.018	3.318
Pot Cap-1 Maneuver	835	-	-	1157	-	-	166	159	652	~ 174	199	491
Stage 1	-	-	-	-	-	-	549	540	-	465	471	-
Stage 2	-	-	-	-	-	-	441	395	-	542	538	-
Platoon blocked, %		-	-	-	-	-						
Mov Cap-1 Maneuver	835	-	-	1157	-	-	126	147	652	~ 152	184	491
Mov Cap-2 Maneuver	-	-	-	-	-	-	126	147	-	~ 152	184	-
Stage 1	-	-	-	-	-	-	513	505	-	435	466	-
Stage 2	-	-	-	-	-	-	361	391	-	488	503	-

Approach	EB			WB			NB			SB		
HCM Control Delay, s	1.1			0.1			28.7			\$ 388.8		
HCM LOS							D			F		

Minor Lane/Major Mvmt	NBLn1	EBL	EBT	EBR	WBL	WBT	WBR	SBLn1	SBLn2
Capacity (veh/h)	184	835	-	-	1157	-	-	153	491
HCM Lane V/C Ratio	0.177	0.065	-	-	0.009	-	-	1.918	0.155
HCM Control Delay (s)	28.7	9.6	-	-	8.1	-	-	\$ 486.1	13.7
HCM Lane LOS		D	A	-	-	A	-	F	B
HCM 95th %tile Q(veh)	0.6	0.2	-	-	0	-	-	22.5	0.5

Notes  
 ~: Volume exceeds capacity    \$: Delay exceeds 300s    +: Computation Not Defined    \*: All major volume in platoon

HCM 6th Signalized Intersection Summary  
 12: S Moreland Ave & Todd Rd

Existing Conditions AM

Movement	EBL	EBT	EBR	WBL	WBT	WBR	NBL	NBT	NBR	SBL	SBT	SBR
Lane Configurations												
Traffic Volume (veh/h)	0	290	340	330	240	0	490	0	110	0	0	0
Future Volume (veh/h)	0	290	340	330	240	0	490	0	110	0	0	0
Initial Q (Qb), veh	0	0	0	0	0	0	0	0	0	0	0	0
Ped-Bike Adj(A_pbT)	1.00		1.00	1.00		1.00	1.00		1.00	1.00		1.00
Parking Bus, Adj	1.00	1.00	1.00	1.00	1.00	1.00	1.00	1.00	1.00	1.00	1.00	1.00
Work Zone On Approach		No			No			No			No	
Adj Sat Flow, veh/h/ln	1870	1870	1870	1870	1870	1870	1870	1870	1870	1870	1870	1870
Adj Flow Rate, veh/h	0	315	113	359	261	0	533	0	81	0	0	0
Peak Hour Factor	0.92	0.92	0.92	0.92	0.92	0.92	0.92	0.92	0.92	0.92	0.92	0.92
Percent Heavy Veh, %	2	2	2	2	2	2	2	2	2	2	2	2
Cap, veh/h	0	414	351	475	498	0	611	0	1088	0	3	0
Arrive On Green	0.00	0.22	0.22	0.27	0.27	0.00	0.34	0.00	0.34	0.00	0.00	0.00
Sat Flow, veh/h	0	1870	1585	1781	1870	0	1781	0	3170	0	1870	0
Grp Volume(v), veh/h	0	315	113	359	261	0	533	0	81	0	0	0
Grp Sat Flow(s),veh/h/ln	0	1870	1585	1781	1870	0	1781	0	1585	0	1870	0
Q Serve(g_s), s	0.0	8.6	3.3	10.1	6.5	0.0	15.3	0.0	0.9	0.0	0.0	0.0
Cycle Q Clear(g_c), s	0.0	8.6	3.3	10.1	6.5	0.0	15.3	0.0	0.9	0.0	0.0	0.0
Prop In Lane	0.00		1.00	1.00		0.00	1.00		1.00	0.00		0.00
Lane Grp Cap(c), veh/h	0	414	351	475	498	0	611	0	1088	0	3	0
V/C Ratio(X)	0.00	0.76	0.32	0.76	0.52	0.00	0.87	0.00	0.07	0.00	0.00	0.00
Avail Cap(c_a), veh/h	0	686	582	980	1029	0	817	0	1454	0	275	0
HCM Platoon Ratio	1.00	1.00	1.00	1.00	1.00	1.00	1.00	1.00	1.00	1.00	1.00	1.00
Upstream Filter(I)	0.00	1.00	1.00	1.00	1.00	0.00	1.00	0.00	1.00	0.00	0.00	0.00
Uniform Delay (d), s/veh	0.0	19.9	17.8	18.4	17.0	0.0	16.8	0.0	12.1	0.0	0.0	0.0
Incr Delay (d2), s/veh	0.0	2.9	0.5	2.5	0.9	0.0	8.0	0.0	0.0	0.0	0.0	0.0
Initial Q Delay(d3),s/veh	0.0	0.0	0.0	0.0	0.0	0.0	0.0	0.0	0.0	0.0	0.0	0.0
%ile BackOfQ(50%),veh/ln	0.0	3.6	1.1	3.9	2.5	0.0	6.7	0.0	0.3	0.0	0.0	0.0
Unsig. Movement Delay, s/veh												
LnGrp Delay(d),s/veh	0.0	22.8	18.3	20.9	17.9	0.0	24.8	0.0	12.1	0.0	0.0	0.0
LnGrp LOS	A	C	B	C	B	A	C	A	B	A	A	A
Approach Vol, veh/h		428			620			614				0
Approach Delay, s/veh		21.6			19.6			23.1				0.0
Approach LOS		C			B			C				
Timer - Assigned Phs		2		4		6		8				
Phs Duration (G+Y+Rc), s		0.0		15.3		21.7		17.5				
Change Period (Y+Rc), s		3.0		3.2		3.0		3.0				
Max Green Setting (Gmax), s		8.0		20.0		25.0		30.0				
Max Q Clear Time (g_c+I1), s		0.0		10.6		17.3		12.1				
Green Ext Time (p_c), s		0.0		1.5		1.4		2.4				

Intersection Summary

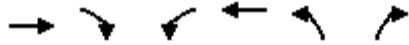
HCM 6th Ctrl Delay	21.4
HCM 6th LOS	C

Notes

- User approved pedestrian interval to be less than phase max green.
- User approved volume balancing among the lanes for turning movement.

HCM 6th Signalized Intersection Summary  
 13: Todd Rd Overpass & Todd Rd

Existing Conditions AM



Movement	EBT	EBR	WBL	WBT	NBL	NBR
Lane Configurations	↑↑	↗	↖	↑↑	↖	↗
Traffic Volume (veh/h)	170	240	350	250	220	470
Future Volume (veh/h)	170	240	350	250	220	470
Initial Q (Qb), veh	0	0	0	0	0	0
Ped-Bike Adj(A_pbT)		1.00	1.00		1.00	1.00
Parking Bus, Adj	1.00	1.00	1.00	1.00	1.00	1.00
Work Zone On Approach	No			No	No	
Adj Sat Flow, veh/h/ln	1870	1870	1870	1870	1870	1870
Adj Flow Rate, veh/h	185	56	380	272	239	272
Peak Hour Factor	0.92	0.92	0.92	0.92	0.92	0.92
Percent Heavy Veh, %	2	2	2	2	2	2
Cap, veh/h	476	212	961	505	409	1393
Arrive On Green	0.13	0.13	0.27	0.27	0.23	0.23
Sat Flow, veh/h	3647	1585	3563	1870	1781	2790
Grp Volume(v), veh/h	185	56	380	272	239	272
Grp Sat Flow(s),veh/h/ln	1777	1585	1781	1870	1781	1395
Q Serve(g_s), s	1.4	0.9	2.5	3.6	3.4	1.5
Cycle Q Clear(g_c), s	1.4	0.9	2.5	3.6	3.4	1.5
Prop In Lane		1.00	1.00		1.00	1.00
Lane Grp Cap(c), veh/h	476	212	961	505	409	1393
V/C Ratio(X)	0.39	0.26	0.40	0.54	0.58	0.20
Avail Cap(c_a), veh/h	2481	1107	1866	979	871	2116
HCM Platoon Ratio	1.00	1.00	1.00	1.00	1.00	1.00
Upstream Filter(I)	1.00	1.00	1.00	1.00	1.00	1.00
Uniform Delay (d), s/veh	11.3	11.1	8.5	8.9	9.8	4.0
Incr Delay (d2), s/veh	0.5	0.7	0.3	0.9	1.3	0.1
Initial Q Delay(d3),s/veh	0.0	0.0	0.0	0.0	0.0	0.0
%ile BackOfQ(50%),veh/ln	0.4	0.3	0.7	1.1	1.0	0.5
Unsig. Movement Delay, s/veh						
LnGrp Delay(d),s/veh	11.8	11.8	8.8	9.8	11.1	4.0
LnGrp LOS	B	B	A	A	B	A
Approach Vol, veh/h	241			652	511	
Approach Delay, s/veh	11.8			9.2	7.4	
Approach LOS	B			A	A	
Timer - Assigned Phs		2			6	8
Phs Duration (G+Y+Rc), s		7.3			11.2	10.1
Change Period (Y+Rc), s		3.5			3.5	3.5
Max Green Setting (Gmax), s		20.0			15.0	14.0
Max Q Clear Time (g_c+I1), s		3.4			5.6	5.4
Green Ext Time (p_c), s		1.1			2.2	1.3
<b>Intersection Summary</b>						
HCM 6th Ctrl Delay			9.0			
HCM 6th LOS			A			
<b>Notes</b>						
User approved volume balancing among the lanes for turning movement.						

HCM 6th Signalized Intersection Summary  
 14: Santa Rosa Ave & Todd Rd

Existing Conditions AM



Movement	EBL	EBT	EBR	WBL	WBT	WBR	NBL	NBT	NBR	SBL	SBT	SBR
Lane Configurations	↖	↖	↖	↖	↖		↖	↑↑	↖	↖	↑↑	↖
Traffic Volume (veh/h)	300	100	240	20	30	30	330	640	40	50	310	240
Future Volume (veh/h)	300	100	240	20	30	30	330	640	40	50	310	240
Initial Q (Qb), veh	0	0	0	0	0	0	0	0	0	0	0	0
Ped-Bike Adj(A_pbT)	1.00		0.99	1.00		1.00	1.00		0.99	1.00		0.99
Parking Bus, Adj	1.00	1.00	1.00	1.00	1.00	1.00	1.00	1.00	1.00	1.00	1.00	1.00
Work Zone On Approach		No			No			No			No	
Adj Sat Flow, veh/h/ln	1870	1870	1870	1870	1870	1870	1870	1870	1870	1870	1870	1870
Adj Flow Rate, veh/h	218	261	52	22	33	1	359	696	17	54	337	56
Peak Hour Factor	0.92	0.92	0.92	0.92	0.92	0.92	0.92	0.92	0.92	0.92	0.92	0.92
Percent Heavy Veh, %	2	2	2	2	2	2	2	2	2	2	2	2
Cap, veh/h	335	352	296	75	76	2	415	1201	532	73	540	238
Arrive On Green	0.19	0.19	0.19	0.04	0.04	0.04	0.23	0.34	0.34	0.04	0.15	0.15
Sat Flow, veh/h	1781	1870	1572	1781	1806	55	1781	3554	1573	1781	3554	1569
Grp Volume(v), veh/h	218	261	52	22	0	34	359	696	17	54	337	56
Grp Sat Flow(s),veh/h/ln	1781	1870	1572	1781	0	1861	1781	1777	1573	1781	1777	1569
Q Serve(g_s), s	6.1	7.1	1.5	0.6	0.0	1.0	10.4	8.7	0.4	1.6	4.8	1.7
Cycle Q Clear(g_c), s	6.1	7.1	1.5	0.6	0.0	1.0	10.4	8.7	0.4	1.6	4.8	1.7
Prop In Lane	1.00		1.00	1.00		0.03	1.00		1.00	1.00		1.00
Lane Grp Cap(c), veh/h	335	352	296	75	0	78	415	1201	532	73	540	238
V/C Ratio(X)	0.65	0.74	0.18	0.29	0.00	0.43	0.87	0.58	0.03	0.74	0.62	0.23
Avail Cap(c_a), veh/h	596	626	526	331	0	346	563	1586	702	331	1057	467
HCM Platoon Ratio	1.00	1.00	1.00	1.00	1.00	1.00	1.00	1.00	1.00	1.00	1.00	1.00
Upstream Filter(I)	1.00	1.00	1.00	1.00	0.00	1.00	1.00	1.00	1.00	1.00	1.00	1.00
Uniform Delay (d), s/veh	20.2	20.6	18.3	25.0	0.0	25.1	19.8	14.7	11.9	25.5	21.4	20.1
Incr Delay (d2), s/veh	0.8	1.2	0.1	0.8	0.0	1.4	8.2	0.2	0.0	5.2	0.4	0.2
Initial Q Delay(d3),s/veh	0.0	0.0	0.0	0.0	0.0	0.0	0.0	0.0	0.0	0.0	0.0	0.0
%ile BackOfQ(50%),veh/ln	2.4	2.9	0.5	0.3	0.0	0.4	4.7	3.0	0.1	0.7	1.8	0.6
Unsig. Movement Delay, s/veh												
LnGrp Delay(d),s/veh	21.0	21.8	18.4	25.8	0.0	26.5	28.0	14.8	11.9	30.7	21.8	20.2
LnGrp LOS	C	C	B	C	A	C	C	B	B	C	C	C
Approach Vol, veh/h		531			56			1072			447	
Approach Delay, s/veh		21.1			26.2			19.2			22.7	
Approach LOS		C			C			B			C	
Timer - Assigned Phs		2	3	4		6	7	8				
Phs Duration (G+Y+Rc), s		15.2	17.6	13.6		7.4	7.6	23.6				
Change Period (Y+Rc), s		5.1	5.1	5.4		5.1	5.4	* 5.4				
Max Green Setting (Gmax), s		18.0	17.0	16.0		10.0	10.0	* 24				
Max Q Clear Time (g_c+I1), s		9.1	12.4	6.8		3.0	3.6	10.7				
Green Ext Time (p_c), s		0.7	0.2	0.8		0.0	0.0	2.1				

Intersection Summary

HCM 6th Ctrl Delay	20.6
HCM 6th LOS	C

Notes

- User approved pedestrian interval to be less than phase max green.
- User approved volume balancing among the lanes for turning movement.
- \* HCM 6th computational engine requires equal clearance times for the phases crossing the barrier.

**Intersection**

Intersection Delay, s/veh 11.4

Intersection LOS B

Movement	EBL	EBT	EBR	WBL	WBT	WBR	NBL	NBT	NBR	SBL	SBT	SBR
Lane Configurations		↕			↕			↕			↕	
Traffic Vol, veh/h	40	10	240	10	10	10	120	110	10	10	190	40
Future Vol, veh/h	40	10	240	10	10	10	120	110	10	10	190	40
Peak Hour Factor	0.92	0.92	0.92	0.92	0.92	0.92	0.92	0.92	0.92	0.92	0.92	0.92
Heavy Vehicles, %	2	2	2	2	2	2	2	2	2	2	2	2
Mvmt Flow	43	11	261	11	11	11	130	120	11	11	207	43
Number of Lanes	0	1	0	0	1	0	0	1	0	0	1	0

Approach	EB	WB	NB	SB
Opposing Approach	WB	EB	SB	NB
Opposing Lanes	1	1	1	1
Conflicting Approach Left	SB	NB	EB	WB
Conflicting Lanes Left	1	1	1	1
Conflicting Approach Right	NB	SB	WB	EB
Conflicting Lanes Right	1	1	1	1
HCM Control Delay	11.6	9.1	11.6	11.2
HCM LOS	B	A	B	B

Lane	NBLn1	EBLn1	WBLn1	SBLn1
Vol Left, %	50%	14%	33%	4%
Vol Thru, %	46%	3%	33%	79%
Vol Right, %	4%	83%	33%	17%
Sign Control	Stop	Stop	Stop	Stop
Traffic Vol by Lane	240	290	30	240
LT Vol	120	40	10	10
Through Vol	110	10	10	190
RT Vol	10	240	10	40
Lane Flow Rate	261	315	33	261
Geometry Grp	1	1	1	1
Degree of Util (X)	0.384	0.43	0.052	0.373
Departure Headway (Hd)	5.3	4.912	5.694	5.144
Convergence, Y/N	Yes	Yes	Yes	Yes
Cap	678	738	627	699
Service Time	3.337	2.912	3.743	3.18
HCM Lane V/C Ratio	0.385	0.427	0.053	0.373
HCM Control Delay	11.6	11.6	9.1	11.2
HCM Lane LOS	B	B	A	B
HCM 95th-tile Q	1.8	2.2	0.2	1.7

HCM 6th TWSC  
16: Riverside Dr & Verano Ave

Existing Conditions AM

Intersection												
Int Delay, s/veh	11.3											
Movement	EBL	EBT	EBR	WBL	WBT	WBR	NBL	NBT	NBR	SBL	SBT	SBR
Lane Configurations												
Traffic Vol, veh/h	40	260	10	90	220	50	20	20	20	120	20	40
Future Vol, veh/h	40	260	10	90	220	50	20	20	20	120	20	40
Conflicting Peds, #/hr	0	0	0	0	0	0	0	0	0	0	0	0
Sign Control	Free	Free	Free	Free	Free	Free	Stop	Stop	Stop	Stop	Stop	Stop
RT Channelized	-	-	None	-	-	None	-	-	None	-	-	None
Storage Length	100	-	-	-	-	-	-	-	-	-	-	-
Veh in Median Storage, #	-	0	-	-	0	-	-	0	-	-	0	-
Grade, %	-	0	-	-	0	-	-	0	-	-	0	-
Peak Hour Factor	92	92	92	92	92	92	92	92	92	92	92	92
Heavy Vehicles, %	2	2	2	2	2	2	2	2	2	2	2	2
Mvmt Flow	43	283	11	98	239	54	22	22	22	130	22	43

Major/Minor	Major1			Major2			Minor1			Minor2		
Conflicting Flow All	293	0	0	294	0	0	870	864	289	859	842	266
Stage 1	-	-	-	-	-	-	375	375	-	462	462	-
Stage 2	-	-	-	-	-	-	495	489	-	397	380	-
Critical Hdwy	4.12	-	-	4.12	-	-	7.12	6.52	6.22	7.12	6.52	6.22
Critical Hdwy Stg 1	-	-	-	-	-	-	6.12	5.52	-	6.12	5.52	-
Critical Hdwy Stg 2	-	-	-	-	-	-	6.12	5.52	-	6.12	5.52	-
Follow-up Hdwy	2.218	-	-	2.218	-	-	3.518	4.018	3.318	3.518	4.018	3.318
Pot Cap-1 Maneuver	1269	-	-	1268	-	-	272	292	750	277	301	773
Stage 1	-	-	-	-	-	-	646	617	-	580	565	-
Stage 2	-	-	-	-	-	-	556	549	-	629	614	-
Platoon blocked, %	-	-	-	-	-	-	-	-	-	-	-	-
Mov Cap-1 Maneuver	1269	-	-	1268	-	-	218	256	750	228	264	773
Mov Cap-2 Maneuver	-	-	-	-	-	-	218	256	-	228	264	-
Stage 1	-	-	-	-	-	-	624	596	-	560	512	-
Stage 2	-	-	-	-	-	-	456	498	-	569	593	-

Approach	EB			WB			NB			SB		
HCM Control Delay, s	1			2			20			44.9		
HCM LOS							C			E		

Minor Lane/Major Mvmt	NBLn1	EBL	EBT	EBR	WBL	WBT	WBR	SBLn1
Capacity (veh/h)	305	1269	-	-	1268	-	-	275
HCM Lane V/C Ratio	0.214	0.034	-	-	0.077	-	-	0.711
HCM Control Delay (s)	20	7.9	-	-	8.1	0	-	44.9
HCM Lane LOS	C	A	-	-	A	A	-	E
HCM 95th %tile Q(veh)	0.8	0.1	-	-	0.2	-	-	4.9



HCM 6th Signalized Intersection Summary  
 17: Main St/Petaluma Hill Rd & Old Adobe Rd/Adobe Rd

Existing Conditions AM



Movement	EBL	EBT	EBR	WBL	WBT	WBR	NBL	NBT	NBR	SBL	SBT	SBR
Lane Configurations		↕			↕			↕		↕	↕	
Traffic Volume (veh/h)	40	190	70	10	90	300	40	200	10	370	480	50
Future Volume (veh/h)	40	190	70	10	90	300	40	200	10	370	480	50
Initial Q (Qb), veh	0	0	0	0	0	0	0	0	0	0	0	0
Ped-Bike Adj(A_pbT)	0.99		0.99	1.00		0.99	1.00		1.00	1.00		0.99
Parking Bus, Adj	1.00	1.00	1.00	1.00	1.00	1.00	1.00	1.00	1.00	1.00	1.00	1.00
Work Zone On Approach		No			No			No			No	
Adj Sat Flow, veh/h/ln	1870	1870	1870	1870	1870	1870	1870	1870	1870	1870	1870	1870
Adj Flow Rate, veh/h	43	207	59	11	98	158	43	217	9	402	522	50
Peak Hour Factor	0.92	0.92	0.92	0.92	0.92	0.92	0.92	0.92	0.92	0.92	0.92	0.92
Percent Heavy Veh, %	2	2	2	2	2	2	2	2	2	2	2	2
Cap, veh/h	117	290	77	81	151	228	57	285	12	486	458	44
Arrive On Green	0.23	0.23	0.23	0.23	0.23	0.23	0.19	0.19	0.19	0.27	0.27	0.27
Sat Flow, veh/h	155	1272	337	28	660	997	295	1488	62	1781	1679	161
Grp Volume(v), veh/h	309	0	0	267	0	0	269	0	0	402	0	572
Grp Sat Flow(s),veh/h/ln	1763	0	0	1685	0	0	1845	0	0	1781	0	1840
Q Serve(g_s), s	0.7	0.0	0.0	0.0	0.0	0.0	6.9	0.0	0.0	10.6	0.0	13.7
Cycle Q Clear(g_c), s	8.0	0.0	0.0	7.3	0.0	0.0	6.9	0.0	0.0	10.6	0.0	13.7
Prop In Lane	0.14		0.19	0.04		0.59	0.16		0.03	1.00		0.09
Lane Grp Cap(c), veh/h	484	0	0	459	0	0	354	0	0	486	0	502
V/C Ratio(X)	0.64	0.00	0.00	0.58	0.00	0.00	0.76	0.00	0.00	0.83	0.00	1.14
Avail Cap(c_a), veh/h	898	0	0	1022	0	0	698	0	0	486	0	502
HCM Platoon Ratio	1.00	1.00	1.00	1.00	1.00	1.00	1.00	1.00	1.00	1.00	1.00	1.00
Upstream Filter(I)	1.00	0.00	0.00	1.00	0.00	0.00	1.00	0.00	0.00	1.00	0.00	1.00
Uniform Delay (d), s/veh	18.0	0.0	0.0	17.8	0.0	0.0	19.2	0.0	0.0	17.1	0.0	18.2
Incr Delay (d2), s/veh	0.5	0.0	0.0	0.4	0.0	0.0	2.5	0.0	0.0	10.6	0.0	84.2
Initial Q Delay(d3),s/veh	0.0	0.0	0.0	0.0	0.0	0.0	0.0	0.0	0.0	0.0	0.0	0.0
%ile BackOfQ(50%),veh/ln	2.9	0.0	0.0	2.4	0.0	0.0	3.0	0.0	0.0	5.1	0.0	16.6
Unsig. Movement Delay, s/veh												
LnGrp Delay(d),s/veh	18.5	0.0	0.0	18.2	0.0	0.0	21.7	0.0	0.0	27.7	0.0	102.5
LnGrp LOS	B	A	A	B	A	A	C	A	A	C	A	F
Approach Vol, veh/h		309			267			269				974
Approach Delay, s/veh		18.5			18.2			21.7				71.6
Approach LOS		B			B			C				E
Timer - Assigned Phs		2		4		6		8				
Phs Duration (G+Y+Rc), s		14.2		16.9		19.1		16.9				
Change Period (Y+Rc), s		4.6		* 5.4		5.4		5.4				
Max Green Setting (Gmax), s		19.0		* 24		13.7		28.7				
Max Q Clear Time (g_c+I1), s		8.9		10.0		15.7		9.3				
Green Ext Time (p_c), s		0.9		0.6		0.0		0.5				

Intersection Summary

HCM 6th Ctrl Delay	47.4
HCM 6th LOS	D

Notes

- User approved pedestrian interval to be less than phase max green.
- \* HCM 6th computational engine requires equal clearance times for the phases crossing the barrier.

HCM 6th Signalized Intersection Summary  
 18: Old Redwood Hwy & Main St

Existing Conditions AM



Movement	WBL	WBR	NBT	NBR	SBL	SBT
Lane Configurations						
Traffic Volume (veh/h)	490	20	200	250	30	520
Future Volume (veh/h)	490	20	200	250	30	520
Initial Q (Qb), veh	0	0	0	0	0	0
Ped-Bike Adj(A_pbT)	1.00	1.00		1.00	1.00	
Parking Bus, Adj	1.00	1.00	1.00	1.00	1.00	1.00
Work Zone On Approach	No		No		No	
Adj Sat Flow, veh/h/ln	1870	1870	1870	1870	1870	1870
Adj Flow Rate, veh/h	533	8	217	272	33	565
Peak Hour Factor	0.92	0.92	0.92	0.92	0.92	0.92
Percent Heavy Veh, %	2	2	2	2	2	2
Cap, veh/h	600	534	414	351	54	751
Arrive On Green	0.34	0.34	0.22	0.22	0.03	0.40
Sat Flow, veh/h	1781	1585	1870	1585	1781	1870
Grp Volume(v), veh/h	533	8	217	272	33	565
Grp Sat Flow(s),veh/h/ln	1781	1585	1870	1585	1781	1870
Q Serve(g_s), s	11.7	0.1	4.2	6.7	0.8	10.7
Cycle Q Clear(g_c), s	11.7	0.1	4.2	6.7	0.8	10.7
Prop In Lane	1.00	1.00		1.00	1.00	
Lane Grp Cap(c), veh/h	600	534	414	351	54	751
V/C Ratio(X)	0.89	0.01	0.52	0.78	0.61	0.75
Avail Cap(c_a), veh/h	1293	1151	1358	1151	517	1358
HCM Platoon Ratio	1.00	1.00	1.00	1.00	1.00	1.00
Upstream Filter(I)	1.00	1.00	1.00	1.00	1.00	1.00
Uniform Delay (d), s/veh	13.0	9.1	14.2	15.1	19.8	10.6
Incr Delay (d2), s/veh	1.8	0.0	0.4	1.4	4.0	0.6
Initial Q Delay(d3),s/veh	0.0	0.0	0.0	0.0	0.0	0.0
%ile BackOfQ(50%),veh/ln	1.1	0.0	1.4	2.0	0.3	3.0
Unsig. Movement Delay, s/veh						
LnGrp Delay(d),s/veh	14.8	9.1	14.6	16.5	23.8	11.2
LnGrp LOS	B	A	B	B	C	B
Approach Vol, veh/h	541		489			598
Approach Delay, s/veh	14.7		15.7			11.9
Approach LOS	B		B			B
Timer - Assigned Phs	1	2		4		6
Phs Duration (G+Y+Rc), s	7.5	15.3		18.5		22.8
Change Period (Y+Rc), s	6.2	6.2		4.6		6.2
Max Green Setting (Gmax)	30.0	30.0		30.0		30.0
Max Q Clear Time (g_c+1)	12.8	8.7		13.7		12.7
Green Ext Time (p_c), s	0.0	0.5		0.3		1.0

Intersection Summary

HCM 6th Ctrl Delay	14.0
HCM 6th LOS	B

Notes

User approved pedestrian interval to be less than phase max green.

HCM 6th TWSC  
 19: Private Dwy/Paula Ln & Bodega Ave

Existing Conditions AM

Intersection												
Int Delay, s/veh	1.5											
Movement	EBL	EBT	EBR	WBL	WBT	WBR	NBL	NBT	NBR	SBL	SBT	SBR
Lane Configurations	↖	↗		↖	↗			↕			↕	
Traffic Vol, veh/h	20	500	0	0	370	20	0	0	0	40	0	20
Future Vol, veh/h	20	500	0	0	370	20	0	0	0	40	0	20
Conflicting Peds, #/hr	0	0	0	0	0	0	0	0	0	0	0	0
Sign Control	Free	Free	Free	Free	Free	Free	Stop	Stop	Stop	Stop	Stop	Stop
RT Channelized	-	-	None	-	-	None	-	-	None	-	-	None
Storage Length	90	-	-	90	-	-	-	-	-	-	-	-
Veh in Median Storage, #	-	0	-	-	0	-	-	0	-	-	0	-
Grade, %	-	0	-	-	0	-	-	0	-	-	0	-
Peak Hour Factor	92	92	92	92	92	92	92	92	92	92	92	92
Heavy Vehicles, %	2	2	2	2	2	2	2	2	2	2	2	2
Mvmt Flow	22	543	0	0	402	22	0	0	0	43	0	22

Major/Minor	Major1			Major2			Minor1			Minor2		
Conflicting Flow All	424	0	0	543	0	0	1011	1011	543	1000	1000	413
Stage 1	-	-	-	-	-	-	587	587	-	413	413	-
Stage 2	-	-	-	-	-	-	424	424	-	587	587	-
Critical Hdwy	4.12	-	-	4.12	-	-	7.12	6.52	6.22	7.12	6.52	6.22
Critical Hdwy Stg 1	-	-	-	-	-	-	6.12	5.52	-	6.12	5.52	-
Critical Hdwy Stg 2	-	-	-	-	-	-	6.12	5.52	-	6.12	5.52	-
Follow-up Hdwy	2.218	-	-	2.218	-	-	3.518	4.018	3.318	3.518	4.018	3.318
Pot Cap-1 Maneuver	1135	-	-	1026	-	-	218	240	540	222	243	639
Stage 1	-	-	-	-	-	-	496	497	-	616	594	-
Stage 2	-	-	-	-	-	-	608	587	-	496	497	-
Platoon blocked, %	-	-	-	-	-	-	-	-	-	-	-	-
Mov Cap-1 Maneuver	1135	-	-	1026	-	-	208	235	540	219	238	639
Mov Cap-2 Maneuver	-	-	-	-	-	-	208	235	-	219	238	-
Stage 1	-	-	-	-	-	-	487	488	-	604	594	-
Stage 2	-	-	-	-	-	-	587	587	-	486	488	-

Approach	EB	WB	NB	SB
HCM Control Delay, s	0.3	0	0	21.7
HCM LOS			A	C

Minor Lane/Major Mvmt	NBLn1	EBL	EBT	EBR	WBL	WBT	WBR	SBLn1
Capacity (veh/h)	-	1135	-	-	1026	-	-	280
HCM Lane V/C Ratio	-	0.019	-	-	-	-	-	0.233
HCM Control Delay (s)		0	8.2	-	-	0	-	21.7
HCM Lane LOS		A	A	-	-	A	-	C
HCM 95th %tile Q(veh)	-	0.1	-	-	0	-	-	0.9

HCM 6th Signalized Intersection Summary  
 20: Broadway & Leveroni Rd/Napa Rd

Existing Conditions AM

Movement	EBL	EBT	EBR	WBL	WBT	WBR	NBL	NBT	NBR	SBL	SBT	SBR
Lane Configurations												
Traffic Volume (veh/h)	300	350	80	70	250	270	70	350	120	200	230	80
Future Volume (veh/h)	300	350	80	70	250	270	70	350	120	200	230	80
Initial Q (Qb), veh	0	0	0	0	0	0	0	0	0	0	0	0
Ped-Bike Adj(A_pbT)	1.00		1.00	1.00		1.00	1.00		0.99	1.00		0.99
Parking Bus, Adj	1.00	1.00	1.00	1.00	1.00	1.00	1.00	1.00	1.00	1.00	1.00	1.00
Work Zone On Approach		No			No			No			No	
Adj Sat Flow, veh/h/ln	1870	1870	1870	1870	1870	1870	1870	1870	1870	1870	1870	1870
Adj Flow Rate, veh/h	326	380	80	76	272	261	76	380	98	217	250	57
Peak Hour Factor	0.92	0.92	0.92	0.92	0.92	0.92	0.92	0.92	0.92	0.92	0.92	0.92
Percent Heavy Veh, %	2	2	2	2	2	2	2	2	2	2	2	2
Cap, veh/h	362	622	131	172	270	259	172	493	126	250	634	142
Arrive On Green	0.20	0.42	0.42	0.10	0.31	0.31	0.10	0.18	0.18	0.14	0.22	0.22
Sat Flow, veh/h	1781	1497	315	1781	875	840	1781	2795	712	1781	2879	644
Grp Volume(v), veh/h	326	0	460	76	0	533	76	240	238	217	152	155
Grp Sat Flow(s),veh/h/ln	1781	0	1812	1781	0	1714	1781	1777	1730	1781	1777	1746
Q Serve(g_s), s	17.9	0.0	20.0	4.0	0.0	31.0	4.0	12.9	13.2	12.0	7.3	7.6
Cycle Q Clear(g_c), s	17.9	0.0	20.0	4.0	0.0	31.0	4.0	12.9	13.2	12.0	7.3	7.6
Prop In Lane	1.00		0.17	1.00		0.49	1.00		0.41	1.00		0.37
Lane Grp Cap(c), veh/h	362	0	754	172	0	529	172	313	305	250	391	384
V/C Ratio(X)	0.90	0.00	0.61	0.44	0.00	1.01	0.44	0.77	0.78	0.87	0.39	0.40
Avail Cap(c_a), veh/h	461	0	754	461	0	529	195	478	465	284	478	470
HCM Platoon Ratio	1.00	1.00	1.00	1.00	1.00	1.00	1.00	1.00	1.00	1.00	1.00	1.00
Upstream Filter(I)	1.00	0.00	1.00	1.00	0.00	1.00	1.00	1.00	1.00	1.00	1.00	1.00
Uniform Delay (d), s/veh	39.0	0.0	23.0	42.8	0.0	34.7	42.8	39.4	39.5	42.3	33.4	33.5
Incr Delay (d2), s/veh	17.4	0.0	1.4	1.8	0.0	40.8	1.8	4.0	4.7	22.0	0.6	0.7
Initial Q Delay(d3),s/veh	0.0	0.0	0.0	0.0	0.0	0.0	0.0	0.0	0.0	0.0	0.0	0.0
%ile BackOfQ(50%),veh/ln	9.2	0.0	8.2	1.8	0.0	18.2	1.8	5.7	5.8	6.7	3.2	3.2
Unsig. Movement Delay, s/veh												
LnGrp Delay(d),s/veh	56.4	0.0	24.4	44.6	0.0	75.5	44.6	43.3	44.2	64.3	34.0	34.2
LnGrp LOS	E	A	C	D	A	F	D	D	D	E	C	C
Approach Vol, veh/h		786			609			554			524	
Approach Delay, s/veh		37.7			71.7			43.9			46.6	
Approach LOS		D			E			D			D	
Timer - Assigned Phs	1	2	3	4	5	6	7	8				
Phs Duration (G+Y+Rc), s	13.7	27.1	24.4	35.2	18.1	22.7	13.7	45.9				
Change Period (Y+Rc), s	4.0	5.0	4.0	* 4.2	4.0	5.0	4.0	* 4.2				
Max Green Setting (Gmax), s	11.0	27.0	26.0	* 31	16.0	27.0	26.0	* 31				
Max Q Clear Time (g_c+I1), s	6.0	9.6	19.9	33.0	14.0	15.2	6.0	22.0				
Green Ext Time (p_c), s	0.1	1.5	0.5	0.0	0.1	2.0	0.1	1.8				
<b>Intersection Summary</b>												
HCM 6th Ctrl Delay			49.3									
HCM 6th LOS			D									
<b>Notes</b>												
* HCM 6th computational engine requires equal clearance times for the phases crossing the barrier.												

HCM 6th AWSC  
 1: Geyserville Ave & Canyon Road

Existing Conditions PM

Intersection	
Intersection Delay, s/veh	8.5
Intersection LOS	A

Movement	EBL	EBT	EBR	WBL	WBT	WBR	NBL	NBT	NBR	SBL	SBT	SBR
Lane Configurations		↕			↕			↕			↕	
Traffic Vol, veh/h	40	10	90	10	10	10	130	40	10	10	40	20
Future Vol, veh/h	40	10	90	10	10	10	130	40	10	10	40	20
Peak Hour Factor	0.92	0.92	0.92	0.92	0.92	0.92	0.92	0.92	0.92	0.92	0.92	0.92
Heavy Vehicles, %	2	2	2	2	2	2	2	2	2	2	2	2
Mvmt Flow	43	11	98	11	11	11	141	43	11	11	43	22
Number of Lanes	0	1	0	0	1	0	0	1	0	0	1	0

Approach	EB	WB	NB	SB
Opposing Approach	WB	EB	SB	NB
Opposing Lanes	1	1	1	1
Conflicting Approach Left	SB	NB	EB	WB
Conflicting Lanes Left	1	1	1	1
Conflicting Approach Right	NB	SB	WB	EB
Conflicting Lanes Right	1	1	1	1
HCM Control Delay	8.2	7.8	9.1	7.9
HCM LOS	A	A	A	A

Lane	NBLn1	EBLn1	WBLn1	SBLn1
Vol Left, %	72%	29%	33%	14%
Vol Thru, %	22%	7%	33%	57%
Vol Right, %	6%	64%	33%	29%
Sign Control	Stop	Stop	Stop	Stop
Traffic Vol by Lane	180	140	30	70
LT Vol	130	40	10	10
Through Vol	40	10	10	40
RT Vol	10	90	10	20
Lane Flow Rate	196	152	33	76
Geometry Grp	1	1	1	1
Degree of Util (X)	0.247	0.181	0.042	0.094
Departure Headway (Hd)	4.542	4.277	4.606	4.428
Convergence, Y/N	Yes	Yes	Yes	Yes
Cap	790	840	777	810
Service Time	2.566	2.298	2.634	2.454
HCM Lane V/C Ratio	0.248	0.181	0.042	0.094
HCM Control Delay	9.1	8.2	7.8	7.9
HCM Lane LOS	A	A	A	A
HCM 95th-tile Q	1	0.7	0.1	0.3

# HCM 6th Signalized Intersection Summary

## 2: Armstrong Woods Rd & River Rd

Existing Conditions PM



Movement	EBL	EBT	EBR	WBL	WBT	WBR	NBL	NBT	NBR	SBL	SBT	SBR
Lane Configurations												
Traffic Volume (veh/h)	50	360	0	0	430	170	10	30	20	80	0	60
Future Volume (veh/h)	50	360	0	0	430	170	10	30	20	80	0	60
Initial Q (Qb), veh	0	0	0	0	0	0	0	0	0	0	0	0
Ped-Bike Adj(A_pbT)	1.00		1.00	1.00		0.99	0.99		0.99	0.99		0.99
Parking Bus, Adj	1.00	1.00	1.00	1.00	1.00	1.00	1.00	1.00	1.00	1.00	1.00	1.00
Work Zone On Approach		No			No			No			No	
Adj Sat Flow, veh/h/ln	1870	1870	0	0	1870	1870	1870	1870	1870	1870	1870	1870
Adj Flow Rate, veh/h	54	391	0	0	467	92	11	33	4	87	0	11
Peak Hour Factor	0.92	0.92	0.92	0.92	0.92	0.92	0.92	0.92	0.92	0.92	0.92	0.92
Percent Heavy Veh, %	2	2	0	0	2	2	2	2	2	2	2	2
Cap, veh/h	519	1103	0	0	723	609	458	327	40	438	0	313
Arrive On Green	0.10	0.59	0.00	0.00	0.39	0.39	0.20	0.20	0.18	0.20	0.00	0.18
Sat Flow, veh/h	1781	1870	0	0	1870	1575	1386	1634	198	1355	0	1566
Grp Volume(v), veh/h	54	391	0	0	467	92	11	0	37	87	0	11
Grp Sat Flow(s),veh/h/ln	1781	1870	0	0	1870	1575	1386	0	1832	1355	0	1566
Q Serve(g_s), s	0.6	4.1	0.0	0.0	7.8	1.4	0.2	0.0	0.6	2.1	0.0	0.2
Cycle Q Clear(g_c), s	0.6	4.1	0.0	0.0	7.8	1.4	0.5	0.0	0.6	2.8	0.0	0.2
Prop In Lane	1.00		0.00	0.00		1.00	1.00		0.11	1.00		1.00
Lane Grp Cap(c), veh/h	519	1103	0	0	723	609	458	0	366	438	0	313
V/C Ratio(X)	0.10	0.35	0.00	0.00	0.65	0.15	0.02	0.00	0.10	0.20	0.00	0.04
Avail Cap(c_a), veh/h	704	1607	0	0	3573	3008	862	0	900	833	0	770
HCM Platoon Ratio	1.00	1.00	1.00	1.00	1.00	1.00	1.00	1.00	1.00	1.00	1.00	1.00
Upstream Filter(I)	1.00	1.00	0.00	0.00	1.00	1.00	1.00	0.00	1.00	1.00	0.00	1.00
Uniform Delay (d), s/veh	5.5	4.0	0.0	0.0	9.5	7.6	12.5	0.0	12.5	13.6	0.0	12.6
Incr Delay (d2), s/veh	0.1	0.2	0.0	0.0	1.0	0.1	0.0	0.0	0.1	0.2	0.0	0.0
Initial Q Delay(d3),s/veh	0.0	0.0	0.0	0.0	0.0	0.0	0.0	0.0	0.0	0.0	0.0	0.0
%ile BackOfQ(50%),veh/ln	0.1	0.9	0.0	0.0	2.6	0.4	0.1	0.0	0.2	0.6	0.0	0.1
Unsig. Movement Delay, s/veh												
LnGrp Delay(d),s/veh	5.6	4.2	0.0	0.0	10.5	7.7	12.5	0.0	12.6	13.8	0.0	12.6
LnGrp LOS	A	A	A	A	B	A	B	A	B	B	A	B
Approach Vol, veh/h		445			559			48				98
Approach Delay, s/veh		4.4			10.1			12.6				13.6
Approach LOS		A			B			B				B
Timer - Assigned Phs		2		4	5	6		8				
Phs Duration (G+Y+Rc), s		26.5		11.6	7.7	18.7		11.6				
Change Period (Y+Rc), s		* 4.7		* 4.7	* 4.7	* 4.7		* 4.7				
Max Green Setting (Gmax), s		* 32		* 18	* 7	* 72		* 18				
Max Q Clear Time (g_c+I1), s		6.1		4.8	2.6	9.8		2.6				
Green Ext Time (p_c), s		2.6		0.2	0.0	3.9		0.1				

### Intersection Summary

HCM 6th Ctrl Delay	8.3
HCM 6th LOS	A

### Notes

User approved pedestrian interval to be less than phase max green.  
 \* HCM 6th computational engine requires equal clearance times for the phases crossing the barrier.

# HCM 6th Signalized Intersection Summary

## 3: Gravenstein Hwy/Old River Rd & River Rd

Existing Conditions PM



Movement	EBL	EBT	EBR	WBL	WBT	WBR	NBL	NBT	NBR	SBL	SBT	SBR
Lane Configurations		↑	↗	↘	↗	↘	↗	↘			↕	
Traffic Volume (veh/h)	0	340	120	60	430	20	140	10	30	20	20	30
Future Volume (veh/h)	0	340	120	60	430	20	140	10	30	20	20	30
Initial Q (Qb), veh	0	0	0	0	0	0	0	0	0	0	0	0
Ped-Bike Adj(A_pbT)	1.00		0.99	1.00		1.00	0.99		1.00	1.00		0.99
Parking Bus, Adj	1.00	1.00	1.00	1.00	1.00	1.00	1.00	1.00	1.00	1.00	1.00	1.00
Work Zone On Approach		No			No			No			No	
Adj Sat Flow, veh/h/ln	0	1870	1870	1870	1870	1870	1870	1870	1870	1870	1870	1870
Adj Flow Rate, veh/h	0	370	78	65	467	20	152	11	7	22	22	7
Peak Hour Factor	0.92	0.92	0.92	0.92	0.92	0.92	0.92	0.92	0.92	0.92	0.92	0.92
Percent Heavy Veh, %	0	2	2	2	2	2	2	2	2	2	2	2
Cap, veh/h	0	586	493	568	988	42	519	250	159	253	217	53
Arrive On Green	0.00	0.31	0.31	0.14	0.56	0.54	0.23	0.23	0.22	0.23	0.23	0.22
Sat Flow, veh/h	0	1870	1572	1781	1780	76	1367	1068	680	500	929	227
Grp Volume(v), veh/h	0	370	78	65	0	487	152	0	18	51	0	0
Grp Sat Flow(s),veh/h/ln	0	1870	1572	1781	0	1856	1367	0	1748	1656	0	0
Q Serve(g_s), s	0.0	6.4	1.4	0.7	0.0	6.0	2.5	0.0	0.3	0.0	0.0	0.0
Cycle Q Clear(g_c), s	0.0	6.4	1.4	0.7	0.0	6.0	3.4	0.0	0.3	0.8	0.0	0.0
Prop In Lane	0.00		1.00	1.00		0.04	1.00		0.39	0.43		0.14
Lane Grp Cap(c), veh/h	0	586	493	568	0	1030	519	0	409	523	0	0
V/C Ratio(X)	0.00	0.63	0.16	0.11	0.00	0.47	0.29	0.00	0.04	0.10	0.00	0.00
Avail Cap(c_a), veh/h	0	1218	1024	781	0	1209	1305	0	1415	600	0	0
HCM Platoon Ratio	1.00	1.00	1.00	1.00	1.00	1.00	1.00	1.00	1.00	1.00	1.00	1.00
Upstream Filter(I)	0.00	1.00	1.00	1.00	0.00	1.00	1.00	0.00	1.00	1.00	0.00	0.00
Uniform Delay (d), s/veh	0.0	11.1	9.4	5.9	0.0	5.1	12.3	0.0	11.4	11.5	0.0	0.0
Incr Delay (d2), s/veh	0.0	1.1	0.1	0.1	0.0	0.3	0.3	0.0	0.0	0.1	0.0	0.0
Initial Q Delay(d3),s/veh	0.0	0.0	0.0	0.0	0.0	0.0	0.0	0.0	0.0	0.0	0.0	0.0
%ile BackOfQ(50%),veh/ln	0.0	2.3	0.4	0.2	0.0	1.4	1.0	0.0	0.1	0.3	0.0	0.0
Unsig. Movement Delay, s/veh												
LnGrp Delay(d),s/veh	0.0	12.3	9.6	6.0	0.0	5.4	12.7	0.0	11.4	11.6	0.0	0.0
LnGrp LOS	A	B	A	A	A	A	B	A	B	B	A	A
Approach Vol, veh/h		448			552			170				51
Approach Delay, s/veh		11.8			5.5			12.5				11.6
Approach LOS		B			A			B				B
Timer - Assigned Phs	1	2		4		6		8				
Phs Duration (G+Y+Rc), s	9.2	15.9		12.9		25.1		12.9				
Change Period (Y+Rc), s	4.7	* 4.7		* 4.7		* 4.7		* 4.7				
Max Green Setting (Gmax), s	24	* 24		* 10		* 24		* 30				
Max Q Clear Time (g_c+1/2), s	8.4	8.4		2.8		8.0		5.4				
Green Ext Time (p_c), s	0.1	2.3		0.1		3.0		0.5				

### Intersection Summary

HCM 6th Ctrl Delay	9.0
HCM 6th LOS	A

### Notes

User approved pedestrian interval to be less than phase max green.  
 \* HCM 6th computational engine requires equal clearance times for the phases crossing the barrier.

HCM 6th TWSC  
4: Old Redwood Hwy & Fulton Rd

Existing Conditions PM

Intersection						
Int Delay, s/veh	45.9					
Movement	EBL	EBR	NBL	NBT	SBT	SBR
Lane Configurations	↖	↗	↖	↗	↗	↖
Traffic Vol, veh/h	270	50	40	550	440	220
Future Vol, veh/h	270	50	40	550	440	220
Conflicting Peds, #/hr	0	0	0	0	0	0
Sign Control	Stop	Stop	Free	Free	Free	Free
RT Channelized	-	Stop	-	None	-	None
Storage Length	0	90	70	-	-	100
Veh in Median Storage, #	0	-	-	0	0	-
Grade, %	0	-	-	0	0	-
Peak Hour Factor	92	92	92	92	92	92
Heavy Vehicles, %	2	2	2	2	2	2
Mvmt Flow	293	54	43	598	478	239

Major/Minor	Minor2	Major1	Major2			
Conflicting Flow All	1162	478	717	0	-	0
Stage 1	478	-	-	-	-	-
Stage 2	684	-	-	-	-	-
Critical Hdwy	6.42	6.22	4.12	-	-	-
Critical Hdwy Stg 1	5.42	-	-	-	-	-
Critical Hdwy Stg 2	5.42	-	-	-	-	-
Follow-up Hdwy	3.518	3.318	2.218	-	-	-
Pot Cap-1 Maneuver	~ 216	587	884	-	-	-
Stage 1	624	-	-	-	-	-
Stage 2	501	-	-	-	-	-
Platoon blocked, %				-	-	-
Mov Cap-1 Maneuver	~ 205	587	884	-	-	-
Mov Cap-2 Maneuver	~ 205	-	-	-	-	-
Stage 1	593	-	-	-	-	-
Stage 2	501	-	-	-	-	-

Approach	EB	NB	SB
HCM Control Delay, s	224.3	0.6	0
HCM LOS	F		

Minor Lane/Major Mvmt	NBL	NBT	EBLn1	EBLn2	SBT	SBR
Capacity (veh/h)	884	-	205	587	-	-
HCM Lane V/C Ratio	0.049	-	1.432	0.093	-	-
HCM Control Delay (s)	9.3	-	263.7	11.8	-	-
HCM Lane LOS	A	-	F	B	-	-
HCM 95th %tile Q(veh)	0.2	-	17.4	0.3	-	-























Notes  
 -: Volume exceeds capacity    \$: Delay exceeds 300s    +: Computation Not Defined    \*: All major volume in platoon



# HCM 6th Signalized Intersection Summary

## 5: Fulton Rd & Airport Blvd

Existing Conditions PM

												
Movement	EBL	EBT	EBR	WBL	WBT	WBR	NBL	NBT	NBR	SBL	SBT	SBR
Lane Configurations												
Traffic Volume (veh/h)	150	620	490	120	310	30	430	270	150	40	220	100
Future Volume (veh/h)	150	620	490	120	310	30	430	270	150	40	220	100
Initial Q (Qb), veh	0	0	0	0	0	0	0	0	0	0	0	0
Ped-Bike Adj(A_pbT)	1.00		0.99	1.00		0.99	1.00		0.99	1.00		0.99
Parking Bus, Adj	1.00	1.00	1.00	1.00	1.00	1.00	1.00	1.00	1.00	1.00	1.00	1.00
Work Zone On Approach		No			No			No			No	
Adj Sat Flow, veh/h/ln	1870	1870	1870	1870	1870	1870	1870	1870	1870	1870	1870	1870
Adj Flow Rate, veh/h	163	674	284	130	337	30	467	293	41	43	239	98
Peak Hour Factor	0.92	0.92	0.92	0.92	0.92	0.92	0.92	0.92	0.92	0.92	0.92	0.92
Percent Heavy Veh, %	2	2	2	2	2	2	2	2	2	2	2	2
Cap, veh/h	218	532	447	185	449	40	503	528	444	38	209	86
Arrive On Green	0.12	0.28	0.28	0.10	0.27	0.25	0.28	0.28	0.28	0.19	0.19	0.18
Sat Flow, veh/h	1781	1870	1571	1781	1691	151	1781	1870	1571	201	1115	457
Grp Volume(v), veh/h	163	674	284	130	0	367	467	293	41	380	0	0
Grp Sat Flow(s),veh/h/ln	1781	1870	1571	1781	0	1841	1781	1870	1571	1773	0	0
Q Serve(g_s), s	9.9	32.0	17.8	7.9	0.0	20.6	28.7	15.0	2.2	21.1	0.0	0.0
Cycle Q Clear(g_c), s	9.9	32.0	17.8	7.9	0.0	20.6	28.7	15.0	2.2	21.1	0.0	0.0
Prop In Lane	1.00		1.00	1.00		0.08	1.00		1.00	0.11		0.26
Lane Grp Cap(c), veh/h	218	532	447	185	0	489	503	528	444	332	0	0
V/C Ratio(X)	0.75	1.27	0.64	0.70	0.00	0.75	0.93	0.55	0.09	1.14	0.00	0.00
Avail Cap(c_a), veh/h	345	532	447	339	0	605	503	528	444	332	0	0
HCM Platoon Ratio	1.00	1.00	1.00	1.00	1.00	1.00	1.00	1.00	1.00	1.00	1.00	1.00
Upstream Filter(I)	1.00	1.00	1.00	1.00	0.00	1.00	1.00	1.00	1.00	1.00	0.00	0.00
Uniform Delay (d), s/veh	47.7	40.3	35.2	48.8	0.0	38.0	39.3	34.4	29.8	45.9	0.0	0.0
Incr Delay (d2), s/veh	1.9	134.8	2.3	1.8	0.0	3.0	23.3	0.8	0.0	94.1	0.0	0.0
Initial Q Delay(d3),s/veh	0.0	0.0	0.0	0.0	0.0	0.0	0.0	0.0	0.0	0.0	0.0	0.0
%ile BackOfQ(50%),veh/ln	4.4	33.9	6.8	3.6	0.0	9.4	15.2	6.7	0.8	17.8	0.0	0.0
Unsig. Movement Delay, s/veh												
LnGrp Delay(d),s/veh	49.6	175.1	37.5	50.6	0.0	41.0	62.6	35.1	29.8	139.9	0.0	0.0
LnGrp LOS	D	F	D	D	A	D	E	D	C	F	A	A
Approach Vol, veh/h		1121			497			801			380	
Approach Delay, s/veh		122.0			43.5			50.8			139.9	
Approach LOS		F			D			D			F	
Timer - Assigned Phs	1	2		4	5	6		8				
Phs Duration (G+Y+Rc), s	15.7	36.0		25.1	17.8	33.9		35.8				
Change Period (Y+Rc), s	5.8	6.0		5.1	5.8	6.0		5.8				
Max Green Setting (Gmax), s	19.6	30.0		20.0	20.0	35.0		30.0				
Max Q Clear Time (g_c+I1), s	9.9	34.0		23.1	11.9	22.6		30.7				
Green Ext Time (p_c), s	0.1	0.0		0.0	0.1	1.0		0.0				
<b>Intersection Summary</b>												
HCM 6th Ctrl Delay				90.1								
HCM 6th LOS				F								
<b>Notes</b>												
User approved pedestrian interval to be less than phase max green.												

HCM 6th Signalized Intersection Summary  
6: Old Redwood Hwy & Airport Blvd

Existing Conditions PM



Movement	EBL	EBT	EBR	WBL	WBT	WBR	NBL	NBT	NBR	SBL	SBT	SBR
Lane Configurations												
Traffic Volume (veh/h)	70	160	400	20	90	30	240	540	20	50	400	50
Future Volume (veh/h)	70	160	400	20	90	30	240	540	20	50	400	50
Initial Q (Qb), veh	0	0	0	0	0	0	0	0	0	0	0	0
Ped-Bike Adj(A_pbT)	1.00		1.00	1.00		1.00	1.00		1.00	1.00		1.00
Parking Bus, Adj	1.00	1.00	1.00	1.00	1.00	1.00	1.00	1.00	1.00	1.00	1.00	1.00
Work Zone On Approach		No			No			No			No	
Adj Sat Flow, veh/h/ln	1870	1870	1870	1870	1870	1870	1870	1870	1870	1870	1870	1870
Adj Flow Rate, veh/h	76	174	90	22	98	20	261	587	10	54	435	18
Peak Hour Factor	0.92	0.92	0.92	0.92	0.92	0.92	0.92	0.92	0.92	0.92	0.92	0.92
Percent Heavy Veh, %	2	2	2	2	2	2	2	2	2	2	2	2
Cap, veh/h	144	303	257	59	148	30	350	794	673	114	546	463
Arrive On Green	0.08	0.16	0.16	0.03	0.10	0.09	0.20	0.42	0.42	0.06	0.29	0.29
Sat Flow, veh/h	1781	1870	1585	1781	1507	308	1781	1870	1585	1781	1870	1585
Grp Volume(v), veh/h	76	174	90	22	0	118	261	587	10	54	435	18
Grp Sat Flow(s),veh/h/ln	1781	1870	1585	1781	0	1815	1781	1870	1585	1781	1870	1585
Q Serve(g_s), s	2.1	4.3	2.5	0.6	0.0	3.2	7.0	13.3	0.2	1.5	10.8	0.4
Cycle Q Clear(g_c), s	2.1	4.3	2.5	0.6	0.0	3.2	7.0	13.3	0.2	1.5	10.8	0.4
Prop In Lane	1.00		1.00	1.00		0.17	1.00		1.00	1.00		1.00
Lane Grp Cap(c), veh/h	144	303	257	59	0	178	350	794	673	114	546	463
V/C Ratio(X)	0.53	0.57	0.35	0.38	0.00	0.66	0.75	0.74	0.01	0.47	0.80	0.04
Avail Cap(c_a), veh/h	473	1533	1299	444	0	956	744	1151	976	391	1151	976
HCM Platoon Ratio	1.00	1.00	1.00	1.00	1.00	1.00	1.00	1.00	1.00	1.00	1.00	1.00
Upstream Filter(I)	1.00	1.00	1.00	1.00	0.00	1.00	1.00	1.00	1.00	1.00	1.00	1.00
Uniform Delay (d), s/veh	22.3	19.6	18.8	23.9	0.0	22.0	19.1	12.2	8.4	22.8	16.5	12.8
Incr Delay (d2), s/veh	1.1	0.6	0.3	1.5	0.0	1.6	1.2	0.6	0.0	1.1	1.0	0.0
Initial Q Delay(d3),s/veh	0.0	0.0	0.0	0.0	0.0	0.0	0.0	0.0	0.0	0.0	0.0	0.0
%ile BackOfQ(50%),veh/ln	0.8	1.7	0.8	0.3	0.0	1.3	2.6	4.4	0.1	0.6	4.0	0.1
Unsig. Movement Delay, s/veh												
LnGrp Delay(d),s/veh	23.4	20.2	19.1	25.4	0.0	23.6	20.3	12.8	8.4	24.0	17.5	12.8
LnGrp LOS	C	C	B	C	A	C	C	B	A	C	B	B
Approach Vol, veh/h		340			140			858			507	
Approach Delay, s/veh		20.6			23.9			15.0			18.0	
Approach LOS		C			C			B			B	
Timer - Assigned Phs	1	2	3	4	5	6	7	8				
Phs Duration (G+Y+Rc), s	5.7	12.2	13.9	18.8	8.1	9.8	7.2	25.5				
Change Period (Y+Rc), s	4.6	5.4	5.1	5.1	5.4	* 5.4	5.1	5.1				
Max Green Setting (Gmax)	12.0	40.0	20.0	30.0	12.0	* 26	10.0	30.0				
Max Q Clear Time (g_c+1)	12.6	6.3	9.0	12.8	4.1	5.2	3.5	15.3				
Green Ext Time (p_c), s	0.0	0.3	0.1	0.8	0.0	0.2	0.0	1.1				

Intersection Summary

HCM 6th Ctrl Delay	17.6
HCM 6th LOS	B

Notes

- User approved pedestrian interval to be less than phase max green.
- \* HCM 6th computational engine requires equal clearance times for the phases crossing the barrier.

HCM 6th TWSC

7: Old Redwood Hwy & Creekside Apts/Faught Rd

Existing Conditions PM

Intersection												
Int Delay, s/veh	22.2											
Movement	EBL	EBT	EBR	WBL	WBT	WBR	NBL	NBT	NBR	SBL	SBT	SBR
Lane Configurations		↕			↕		↕	↑	↑	↑		↕
Traffic Vol, veh/h	10	10	20	70	10	20	20	700	120	30	700	30
Future Vol, veh/h	10	10	20	70	10	20	20	700	120	30	700	30
Conflicting Peds, #/hr	0	0	0	0	0	0	0	0	0	0	0	0
Sign Control	Stop	Stop	Stop	Stop	Stop	Stop	Free	Free	Free	Free	Free	Free
RT Channelized	-	-	None	-	-	None	-	-	None	-	-	None
Storage Length	-	-	-	-	-	-	50	-	270	-	-	-
Veh in Median Storage, #	-	0	-	-	0	-	-	0	-	-	0	-
Grade, %	-	0	-	-	0	-	-	0	-	-	0	-
Peak Hour Factor	92	92	92	92	92	92	92	92	92	92	92	92
Heavy Vehicles, %	2	2	2	2	2	2	2	2	2	2	2	2
Mvmt Flow	11	11	22	76	11	22	22	761	130	33	761	33

Major/Minor	Minor2		Minor1		Major1		Major2					
Conflicting Flow All	1731	1779	778	1665	1665	761	794	0	0	891	0	0
Stage 1	844	844	-	805	805	-	-	-	-	-	-	-
Stage 2	887	935	-	860	860	-	-	-	-	-	-	-
Critical Hdwy	7.12	6.52	6.22	7.12	6.52	6.22	4.12	-	-	4.12	-	-
Critical Hdwy Stg 1	6.12	5.52	-	6.12	5.52	-	-	-	-	-	-	-
Critical Hdwy Stg 2	6.12	5.52	-	6.12	5.52	-	-	-	-	-	-	-
Follow-up Hdwy	3.518	4.018	3.318	3.518	4.018	3.318	2.218	-	-	2.218	-	-
Pot Cap-1 Maneuver	69	82	396	77	97	405	827	-	-	761	-	-
Stage 1	358	379	-	376	395	-	-	-	-	-	-	-
Stage 2	339	344	-	351	373	-	-	-	-	-	-	-
Platoon blocked, %								-	-	-	-	-
Mov Cap-1 Maneuver	55	74	396	~ 60	87	405	827	-	-	761	-	-
Mov Cap-2 Maneuver	55	74	-	~ 60	87	-	-	-	-	-	-	-
Stage 1	348	349	-	366	384	-	-	-	-	-	-	-
Stage 2	303	335	-	296	344	-	-	-	-	-	-	-






















Approach	EB	WB	NB	SB
HCM Control Delay, s	58.4	\$ 357.9	0.2	0.4
HCM LOS	F	F		

Minor Lane/Major Mvmt	NBL	NBT	NBR	EBLn1WBLn1	SBL	SBT	SBR
Capacity (veh/h)	827	-	-	109	75	761	-
HCM Lane V/C Ratio	0.026	-	-	0.399	1.449	0.043	-
HCM Control Delay (s)	9.5	-	-	58.4	357.9	9.9	0
HCM Lane LOS	A	-	-	F	F	A	A
HCM 95th %tile Q(veh)	0.1	-	-	1.7	8.8	0.1	-

Notes  
 -: Volume exceeds capacity    \$: Delay exceeds 300s    +: Computation Not Defined    \*: All major volume in platoon

HCM 6th Signalized Intersection Summary  
 8: Old Redwood Hwy & Mark West Commons Cir/Wikiup Dr

Existing Conditions PM

												
Movement	EBL	EBT	EBR	WBL	WBT	WBR	NBL	NBT	NBR	SBL	SBT	SBR
Lane Configurations												
Traffic Volume (veh/h)	10	10	10	150	10	120	30	690	150	80	650	10
Future Volume (veh/h)	10	10	10	150	10	120	30	690	150	80	650	10
Initial Q (Qb), veh	0	0	0	0	0	0	0	0	0	0	0	0
Ped-Bike Adj(A_pbT)	0.99		0.98	0.99		0.99	1.00		0.99	1.00		1.00
Parking Bus, Adj	1.00	1.00	1.00	1.00	1.00	1.00	1.00	1.00	1.00	1.00	1.00	1.00
Work Zone On Approach		No			No			No			No	
Adj Sat Flow, veh/h/ln	1870	1870	1870	1870	1870	1870	1870	1870	1870	1870	1870	1870
Adj Flow Rate, veh/h	11	11	2	163	11	32	33	750	101	87	707	6
Peak Hour Factor	0.92	0.92	0.92	0.92	0.92	0.92	0.92	0.92	0.92	0.92	0.92	0.92
Percent Heavy Veh, %	2	2	2	2	2	2	2	2	2	2	2	2
Cap, veh/h	166	131	17	398	17	278	96	888	749	152	946	798
Arrive On Green	0.18	0.18	0.17	0.18	0.18	0.18	0.05	0.47	0.47	0.09	0.51	0.51
Sat Flow, veh/h	288	737	93	1380	93	1563	1781	1870	1577	1781	1870	1577
Grp Volume(v), veh/h	24	0	0	174	0	32	33	750	101	87	707	6
Grp Sat Flow(s),veh/h/ln	1118	0	0	1473	0	1563	1781	1870	1577	1781	1870	1577
Q Serve(g_s), s	0.0	0.0	0.0	0.0	0.0	0.8	0.8	16.1	1.6	2.2	13.8	0.1
Cycle Q Clear(g_c), s	4.9	0.0	0.0	4.9	0.0	0.8	0.8	16.1	1.6	2.2	13.8	0.1
Prop In Lane	0.46		0.08	0.94		1.00	1.00		1.00	1.00		1.00
Lane Grp Cap(c), veh/h	314	0	0	415	0	278	96	888	749	152	946	798
V/C Ratio(X)	0.08	0.00	0.00	0.42	0.00	0.11	0.34	0.84	0.13	0.57	0.75	0.01
Avail Cap(c_a), veh/h	466	0	0	952	0	873	509	1270	1070	509	1270	1071
HCM Platoon Ratio	1.00	1.00	1.00	1.00	1.00	1.00	1.00	1.00	1.00	1.00	1.00	1.00
Upstream Filter(I)	1.00	0.00	0.00	1.00	0.00	1.00	1.00	1.00	1.00	1.00	1.00	1.00
Uniform Delay (d), s/veh	15.8	0.0	0.0	17.5	0.0	15.8	20.9	10.5	6.8	20.2	9.0	5.6
Incr Delay (d2), s/veh	0.0	0.0	0.0	0.3	0.0	0.1	0.8	2.6	0.0	1.3	1.0	0.0
Initial Q Delay(d3),s/veh	0.0	0.0	0.0	0.0	0.0	0.0	0.0	0.0	0.0	0.0	0.0	0.0
%ile BackOfQ(50%),veh/ln	0.2	0.0	0.0	1.6	0.0	0.2	0.3	5.1	0.4	0.8	3.9	0.0
Unsig. Movement Delay, s/veh												
LnGrp Delay(d),s/veh	15.8	0.0	0.0	17.7	0.0	15.9	21.7	13.2	6.8	21.4	10.0	5.6
LnGrp LOS	B	A	A	B	A	B	C	B	A	C	B	A
Approach Vol, veh/h		24			206			884			800	
Approach Delay, s/veh		15.8			17.4			12.8			11.2	
Approach LOS		B			B			B			B	
Timer - Assigned Phs		2	3	4		6	7	8				
Phs Duration (G+Y+Rc), s		12.2	6.5	27.2		12.2	7.9	25.8				
Change Period (Y+Rc), s		4.6	5.1	5.1		4.6	5.1	5.1				
Max Green Setting (Gmax), s		12.0	12.0	30.0		25.0	12.0	30.0				
Max Q Clear Time (g_c+I1), s		6.9	2.8	15.8		6.9	4.2	18.1				
Green Ext Time (p_c), s		0.0	0.0	2.1		0.6	0.0	2.2				
<b>Intersection Summary</b>												
HCM 6th Ctrl Delay				12.7								
HCM 6th LOS				B								
<b>Notes</b>												
User approved pedestrian interval to be less than phase max green.												

**Intersection**

Int Delay, s/veh 4.5

Movement	EBL	EBT	WBT	WBR	SBL	SBR
Lane Configurations		↕	↑	↗	↖	↗
Traffic Vol, veh/h	30	170	170	380	240	50
Future Vol, veh/h	30	170	170	380	240	50
Conflicting Peds, #/hr	0	0	0	0	0	0
Sign Control	Free	Free	Free	Free	Stop	Stop
RT Channelized	-	None	-	Yield	-	None
Storage Length	-	-	-	150	90	0
Veh in Median Storage, #	-	0	0	-	0	-
Grade, %	-	0	0	-	0	-
Peak Hour Factor	92	92	92	92	92	92
Heavy Vehicles, %	2	2	2	2	2	2
Mvmt Flow	33	185	185	413	261	54

**Major/Minor**

	Major1	Major2	Minor2		
Conflicting Flow All	185	0	0	436	185
Stage 1	-	-	-	185	-
Stage 2	-	-	-	251	-
Critical Hdwy	4.12	-	-	6.42	6.22
Critical Hdwy Stg 1	-	-	-	5.42	-
Critical Hdwy Stg 2	-	-	-	5.42	-
Follow-up Hdwy	2.218	-	-	3.518	3.318
Pot Cap-1 Maneuver	1390	-	-	578	857
Stage 1	-	-	-	847	-
Stage 2	-	-	-	791	-
Platoon blocked, %	-	-	-	-	-
Mov Cap-1 Maneuver	1390	-	-	563	857
Mov Cap-2 Maneuver	-	-	-	563	-
Stage 1	-	-	-	825	-
Stage 2	-	-	-	791	-

**Approach**




















	EB	WB	SB
HCM Control Delay, s	1.1	0	15.5
HCM LOS			C

**Minor Lane/Major Mvmt**

	EBL	EBT	WBT	WBR	SBLn1	SBLn2
Capacity (veh/h)	1390	-	-	-	563	857
HCM Lane V/C Ratio	0.023	-	-	-	0.463	0.063
HCM Control Delay (s)	7.7	0	-	-	16.8	9.5
HCM Lane LOS	A	A	-	-	C	A
HCM 95th %tile Q(veh)	0.1	-	-	-	2.4	0.2

HCM 6th Signalized Intersection Summary  
 10: Gravenstein Hwy & Graton Rd/Frei Rd

Existing Conditions PM

												
Movement	EBL	EBT	EBR	WBL	WBT	WBR	NBL	NBT	NBR	SBL	SBT	SBR
Lane Configurations												
Traffic Volume (veh/h)	20	20	80	150	40	10	100	400	70	10	360	30
Future Volume (veh/h)	20	20	80	150	40	10	100	400	70	10	360	30
Initial Q (Qb), veh	0	0	0	0	0	0	0	0	0	0	0	0
Ped-Bike Adj(A_pbT)	0.99		0.99	0.99		0.99	1.00		0.99	1.00		0.99
Parking Bus, Adj	1.00	1.00	1.00	1.00	1.00	1.00	1.00	1.00	1.00	1.00	1.00	1.00
Work Zone On Approach		No			No			No			No	
Adj Sat Flow, veh/h/ln	1870	1870	1870	1870	1870	1870	1870	1870	1870	1870	1870	1870
Adj Flow Rate, veh/h	22	22	21	163	43	9	109	435	74	11	391	30
Peak Hour Factor	0.92	0.92	0.92	0.92	0.92	0.92	0.92	0.92	0.92	0.92	0.92	0.92
Percent Heavy Veh, %	2	2	2	2	2	2	2	2	2	2	2	2
Cap, veh/h	275	241	383	370	85	14	352	739	126	85	557	43
Arrive On Green	0.24	0.24	0.24	0.24	0.24	0.22	0.20	0.48	0.44	0.05	0.32	0.29
Sat Flow, veh/h	695	989	1569	1010	349	59	1781	1556	265	1781	1714	131
Grp Volume(v), veh/h	44	0	21	215	0	0	109	0	509	11	0	421
Grp Sat Flow(s),veh/h/ln	1683	0	1569	1418	0	0	1781	0	1821	1781	0	1845
Q Serve(g_s), s	0.0	0.0	0.5	6.1	0.0	0.0	2.7	0.0	10.5	0.3	0.0	10.3
Cycle Q Clear(g_c), s	0.9	0.0	0.5	7.1	0.0	0.0	2.7	0.0	10.5	0.3	0.0	10.3
Prop In Lane	0.50		1.00	0.76		0.04	1.00		0.15	1.00		0.07
Lane Grp Cap(c), veh/h	516	0	383	469	0	0	352	0	865	85	0	600
V/C Ratio(X)	0.09	0.00	0.05	0.46	0.00	0.00	0.31	0.00	0.59	0.13	0.00	0.70
Avail Cap(c_a), veh/h	1696	0	1567	604	0	0	578	0	1833	1755	0	961
HCM Platoon Ratio	1.00	1.00	1.00	1.00	1.00	1.00	1.00	1.00	1.00	1.00	1.00	1.00
Upstream Filter(I)	1.00	0.00	1.00	1.00	0.00	0.00	1.00	0.00	1.00	1.00	0.00	1.00
Uniform Delay (d), s/veh	15.1	0.0	14.9	17.4	0.0	0.0	17.6	0.0	10.0	23.5	0.0	15.3
Incr Delay (d2), s/veh	0.1	0.0	0.1	0.7	0.0	0.0	0.5	0.0	0.6	0.7	0.0	1.5
Initial Q Delay(d3),s/veh	0.0	0.0	0.0	0.0	0.0	0.0	0.0	0.0	0.0	0.0	0.0	0.0
%ile BackOfQ(50%),veh/ln	0.4	0.0	0.2	2.0	0.0	0.0	1.0	0.0	3.0	0.1	0.0	3.6
Unsig. Movement Delay, s/veh												
LnGrp Delay(d),s/veh	15.1	0.0	15.0	18.1	0.0	0.0	18.1	0.0	10.6	24.2	0.0	16.8
LnGrp LOS	B	A	B	B	A	A	B	A	B	C	A	B
Approach Vol, veh/h		65			215			618				432
Approach Delay, s/veh		15.1			18.1			11.9				17.0
Approach LOS		B			B			B				B
Timer - Assigned Phs	1	2		4	5	6		8				
Phs Duration (G+Y+Rc), s	14.2	20.7		16.6	6.4	28.4		16.6				
Change Period (Y+Rc), s	* 4.7	5.8		5.4	* 4.7	5.8		5.4				
Max Green Setting (Gmax), s	* 16	25.0		16.0	* 50	50.0		50.0				
Max Q Clear Time (g_c+I1), s	4.7	12.3		9.1	2.3	12.5		2.9				
Green Ext Time (p_c), s	0.2	1.9		0.6	0.0	3.3		0.3				

Intersection Summary

HCM 6th Ctrl Delay	14.7
HCM 6th LOS	B

Notes

- User approved pedestrian interval to be less than phase max green.
- \* HCM 6th computational engine requires equal clearance times for the phases crossing the barrier.

HCM 6th TWSC  
 11: Private Dwy/Moorland Ave & Todd Rd

Existing Conditions PM

Intersection												
Int Delay, s/veh	349											
Movement	EBL	EBT	EBR	WBL	WBT	WBR	NBL	NBT	NBR	SBL	SBT	SBR
Lane Configurations	↖	↗		↖	↗			↕			↖	↗
Traffic Vol, veh/h	50	520	10	20	420	340	10	20	20	360	20	30
Future Vol, veh/h	50	520	10	20	420	340	10	20	20	360	20	30
Conflicting Peds, #/hr	0	0	0	0	0	0	0	0	0	0	0	0
Sign Control	Free	Free	Free	Free	Free	Free	Stop	Stop	Stop	Stop	Stop	Stop
RT Channelized	-	-	None	-	-	None	-	-	None	-	-	None
Storage Length	100	-	-	70	-	-	-	-	-	-	-	60
Veh in Median Storage, #	-	0	-	-	0	-	-	0	-	-	0	-
Grade, %	-	0	-	-	0	-	-	0	-	-	0	-
Peak Hour Factor	92	92	92	92	92	92	92	92	92	92	92	92
Heavy Vehicles, %	2	2	2	2	2	2	2	2	2	2	2	2
Mvmt Flow	54	565	11	22	457	370	11	22	22	391	22	33

Major/Minor	Major1			Major2			Minor1			Minor2		
Conflicting Flow All	827	0	0	576	0	0	1393	1550	571	1387	1370	642
Stage 1	-	-	-	-	-	-	679	679	-	686	686	-
Stage 2	-	-	-	-	-	-	714	871	-	701	684	-
Critical Hdwy	4.12	-	-	4.12	-	-	7.12	6.52	6.22	7.12	6.52	6.22
Critical Hdwy Stg 1	-	-	-	-	-	-	6.12	5.52	-	6.12	5.52	-
Critical Hdwy Stg 2	-	-	-	-	-	-	6.12	5.52	-	6.12	5.52	-
Follow-up Hdwy	2.218	-	-	2.218	-	-	3.518	4.018	3.318	3.518	4.018	3.318
Pot Cap-1 Maneuver	804	-	-	997	-	-	119	114	520	~ 120	146	474
Stage 1	-	-	-	-	-	-	441	451	-	438	448	-
Stage 2	-	-	-	-	-	-	422	368	-	429	449	-
Platoon blocked, %		-	-		-	-						
Mov Cap-1 Maneuver	804	-	-	997	-	-	91	104	520	~ 90	133	474
Mov Cap-2 Maneuver	-	-	-	-	-	-	91	104	-	~ 90	133	-
Stage 1	-	-	-	-	-	-	411	421	-	409	438	-
Stage 2	-	-	-	-	-	-	365	360	-	~ 364	419	-

Approach	EB			WB			NB			SB		
HCM Control Delay, s	0.8			0.2			43.2			\$ 1542.6		
HCM LOS							E			F		

Minor Lane/Major Mvmt	NBLn1	EBL	EBT	EBR	WBL	WBT	WBR	SBLn1	SBLn2
Capacity (veh/h)	147	804	-	-	997	-	-	92	474
HCM Lane V/C Ratio	0.37	0.068	-	-	0.022	-	-	4.49	0.069
HCM Control Delay (s)	43.2	9.8	-	-	8.7	-	-	\$ 1663.3	13.2
HCM Lane LOS		E	A	-	-	A	-	F	B
HCM 95th %tile Q(veh)	1.6	0.2	-	-	0.1	-	-	43.7	0.2

Notes  
 -: Volume exceeds capacity    \$: Delay exceeds 300s    +: Computation Not Defined    \*: All major volume in platoon

# HCM 6th Signalized Intersection Summary

## 12: S Moreland Ave & Todd Rd

Existing Conditions PM



Movement	EBL	EBT	EBR	WBL	WBT	WBR	NBL	NBT	NBR	SBL	SBT	SBR
Lane Configurations		↖	↗	↖	↗		↖	↗	↗		↕	
Traffic Volume (veh/h)	0	350	550	350	250	0	530	0	120	0	0	0
Future Volume (veh/h)	0	350	550	350	250	0	530	0	120	0	0	0
Initial Q (Qb), veh	0	0	0	0	0	0	0	0	0	0	0	0
Ped-Bike Adj(A_pbT)	1.00		1.00	1.00		1.00	1.00		1.00	1.00		1.00
Parking Bus, Adj	1.00	1.00	1.00	1.00	1.00	1.00	1.00	1.00	1.00	1.00	1.00	1.00
Work Zone On Approach		No			No			No			No	
Adj Sat Flow, veh/h/ln	1870	1870	1870	1870	1870	1870	1870	1870	1870	1870	1870	1870
Adj Flow Rate, veh/h	0	380	265	380	272	0	576	0	87	0	0	0
Peak Hour Factor	0.92	0.92	0.92	0.92	0.92	0.92	0.92	0.92	0.92	0.92	0.92	0.92
Percent Heavy Veh, %	2	2	2	2	2	2	2	2	2	2	2	2
Cap, veh/h	0	437	370	450	472	0	601	0	1070	0	3	0
Arrive On Green	0.00	0.23	0.23	0.25	0.25	0.00	0.34	0.00	0.34	0.00	0.00	0.00
Sat Flow, veh/h	0	1870	1585	1781	1870	0	1781	0	3170	0	1870	0
Grp Volume(v), veh/h	0	380	265	380	272	0	576	0	87	0	0	0
Grp Sat Flow(s),veh/h/ln	0	1870	1585	1781	1870	0	1781	0	1585	0	1870	0
Q Serve(g_s), s	0.0	13.3	10.5	13.8	8.7	0.0	21.6	0.0	1.3	0.0	0.0	0.0
Cycle Q Clear(g_c), s	0.0	13.3	10.5	13.8	8.7	0.0	21.6	0.0	1.3	0.0	0.0	0.0
Prop In Lane	0.00		1.00	1.00		0.00	1.00		1.00	0.00		0.00
Lane Grp Cap(c), veh/h	0	437	370	450	472	0	601	0	1070	0	3	0
V/C Ratio(X)	0.00	0.87	0.72	0.84	0.58	0.00	0.96	0.00	0.08	0.00	0.00	0.00
Avail Cap(c_a), veh/h	0	527	447	759	797	0	628	0	1117	0	192	0
HCM Platoon Ratio	1.00	1.00	1.00	1.00	1.00	1.00	1.00	1.00	1.00	1.00	1.00	1.00
Upstream Filter(I)	0.00	1.00	1.00	1.00	1.00	0.00	1.00	0.00	1.00	0.00	0.00	0.00
Uniform Delay (d), s/veh	0.0	25.1	24.0	24.2	22.3	0.0	22.1	0.0	15.4	0.0	0.0	0.0
Incr Delay (d2), s/veh	0.0	12.7	4.3	4.5	1.1	0.0	25.4	0.0	0.0	0.0	0.0	0.0
Initial Q Delay(d3),s/veh	0.0	0.0	0.0	0.0	0.0	0.0	0.0	0.0	0.0	0.0	0.0	0.0
%ile BackOfQ(50%),veh/ln	0.0	7.0	4.1	5.9	3.7	0.0	12.5	0.0	0.4	0.0	0.0	0.0
Unsig. Movement Delay, s/veh												
LnGrp Delay(d),s/veh	0.0	37.7	28.3	28.6	23.4	0.0	47.4	0.0	15.4	0.0	0.0	0.0
LnGrp LOS	A	D	C	C	C	A	D	A	B	A	A	A
Approach Vol, veh/h		645			652			663			0	
Approach Delay, s/veh		33.9			26.4			43.2			0.0	
Approach LOS		C			C			D				
Timer - Assigned Phs		2			4			6			8	
Phs Duration (G+Y+Rc), s		0.0			19.9			27.0			21.2	
Change Period (Y+Rc), s		3.0			3.2			3.0			3.0	
Max Green Setting (Gmax), s		8.0			20.0			25.0			30.0	
Max Q Clear Time (g_c+I1), s		0.0			15.3			23.6			15.8	
Green Ext Time (p_c), s		0.0			1.4			0.4			2.4	

### Intersection Summary

HCM 6th Ctrl Delay	34.6
HCM 6th LOS	C

### Notes

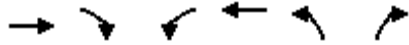
- User approved pedestrian interval to be less than phase max green.
- User approved volume balancing among the lanes for turning movement.



# HCM 6th Signalized Intersection Summary

## 13: Todd Rd Overpass & Todd Rd

Existing Conditions PM



Movement	EBT	EBR	WBL	WBT	NBL	NBR
Lane Configurations	↑↑	↗	↖	↑↑	↖	↗↗
Traffic Volume (veh/h)	190	250	380	360	250	700
Future Volume (veh/h)	190	250	380	360	250	700
Initial Q (Qb), veh	0	0	0	0	0	0
Ped-Bike Adj(A_pbT)		1.00	1.00		1.00	1.00
Parking Bus, Adj	1.00	1.00	1.00	1.00	1.00	1.00
Work Zone On Approach	No			No	No	
Adj Sat Flow, veh/h/ln	1870	1870	1870	1870	1870	1870
Adj Flow Rate, veh/h	207	55	449	340	272	434
Peak Hour Factor	0.92	0.92	0.92	0.92	0.92	0.92
Percent Heavy Veh, %	2	2	2	2	2	2
Cap, veh/h	440	196	990	520	419	1432
Arrive On Green	0.12	0.12	0.28	0.28	0.24	0.24
Sat Flow, veh/h	3647	1585	3563	1870	1781	2790
Grp Volume(v), veh/h	207	55	449	340	272	434
Grp Sat Flow(s),veh/h/ln	1777	1585	1781	1870	1781	1395
Q Serve(g_s), s	1.8	1.0	3.4	5.3	4.6	3.0
Cycle Q Clear(g_c), s	1.8	1.0	3.4	5.3	4.6	3.0
Prop In Lane		1.00	1.00		1.00	1.00
Lane Grp Cap(c), veh/h	440	196	990	520	419	1432
V/C Ratio(X)	0.47	0.28	0.45	0.65	0.65	0.30
Avail Cap(c_a), veh/h	2096	935	1562	820	727	1914
HCM Platoon Ratio	1.00	1.00	1.00	1.00	1.00	1.00
Upstream Filter(I)	1.00	1.00	1.00	1.00	1.00	1.00
Uniform Delay (d), s/veh	13.5	13.1	9.9	10.5	11.4	4.6
Incr Delay (d2), s/veh	0.8	0.8	0.3	1.4	1.7	0.1
Initial Q Delay(d3),s/veh	0.0	0.0	0.0	0.0	0.0	0.0
%ile BackOfQ(50%),veh/ln	0.6	0.3	1.0	1.8	1.5	1.1
Unsig. Movement Delay, s/veh						
LnGrp Delay(d),s/veh	14.3	13.9	10.2	11.9	13.1	4.8
LnGrp LOS	B	B	B	B	B	A
Approach Vol, veh/h	262			789	706	
Approach Delay, s/veh	14.2			10.9	8.0	
Approach LOS	B			B	A	
Timer - Assigned Phs		2		6	8	
Phs Duration (G+Y+Rc), s		8.1		13.2	11.8	
Change Period (Y+Rc), s		3.5		3.5	3.5	
Max Green Setting (Gmax), s		20.0		15.0	14.0	
Max Q Clear Time (g_c+I1), s		3.8		7.3	6.6	
Green Ext Time (p_c), s		1.3		2.4	1.7	
<b>Intersection Summary</b>						
HCM 6th Ctrl Delay			10.2			
HCM 6th LOS			B			
<b>Notes</b>						
User approved volume balancing among the lanes for turning movement.						

# HCM 6th Signalized Intersection Summary

## 14: Santa Rosa Ave & Todd Rd

Existing Conditions PM



Movement	EBL	EBT	EBR	WBL	WBT	WBR	NBL	NBT	NBR	SBL	SBT	SBR
Lane Configurations	↖	↖	↖	↖	↖		↖	↑↑	↖	↖	↑↑	↖
Traffic Volume (veh/h)	470	60	360	50	100	60	350	610	40	30	520	290
Future Volume (veh/h)	470	60	360	50	100	60	350	610	40	30	520	290
Initial Q (Qb), veh	0	0	0	0	0	0	0	0	0	0	0	0
Ped-Bike Adj(A_pbT)	1.00		0.99	1.00		1.00	1.00		0.99	1.00		0.99
Parking Bus, Adj	1.00	1.00	1.00	1.00	1.00	1.00	1.00	1.00	1.00	1.00	1.00	1.00
Work Zone On Approach		No			No			No			No	
Adj Sat Flow, veh/h/ln	1870	1870	1870	1870	1870	1870	1870	1870	1870	1870	1870	1870
Adj Flow Rate, veh/h	557	0	84	54	109	38	380	663	17	33	565	73
Peak Hour Factor	0.92	0.92	0.92	0.92	0.92	0.92	0.92	0.92	0.92	0.92	0.92	0.92
Percent Heavy Veh, %	2	2	2	2	2	2	2	2	2	2	2	2
Cap, veh/h	718	0	317	216	161	56	440	1444	640	82	744	330
Arrive On Green	0.20	0.00	0.20	0.12	0.12	0.11	0.25	0.41	0.41	0.05	0.21	0.21
Sat Flow, veh/h	3563	0	1573	1781	1325	462	1781	3554	1575	1781	3554	1574
Grp Volume(v), veh/h	557	0	84	54	0	147	380	663	17	33	565	73
Grp Sat Flow(s),veh/h/ln	1781	0	1573	1781	0	1787	1781	1777	1575	1781	1777	1574
Q Serve(g_s), s	10.7	0.0	3.3	2.0	0.0	5.7	14.8	9.9	0.5	1.3	10.8	2.8
Cycle Q Clear(g_c), s	10.7	0.0	3.3	2.0	0.0	5.7	14.8	9.9	0.5	1.3	10.8	2.8
Prop In Lane	1.00		1.00	1.00		0.26	1.00		1.00	1.00		1.00
Lane Grp Cap(c), veh/h	718	0	317	216	0	217	440	1444	640	82	744	330
V/C Ratio(X)	0.78	0.00	0.27	0.25	0.00	0.68	0.86	0.46	0.03	0.40	0.76	0.22
Avail Cap(c_a), veh/h	939	0	415	273	0	274	445	1444	640	280	854	378
HCM Platoon Ratio	1.00	1.00	1.00	1.00	1.00	1.00	1.00	1.00	1.00	1.00	1.00	1.00
Upstream Filter(I)	1.00	0.00	1.00	1.00	0.00	1.00	1.00	1.00	1.00	1.00	1.00	1.00
Uniform Delay (d), s/veh	27.4	0.0	24.4	28.8	0.0	30.6	26.1	15.7	12.9	33.6	26.9	23.7
Incr Delay (d2), s/veh	2.1	0.0	0.2	0.2	0.0	2.5	15.2	0.1	0.0	1.2	2.8	0.1
Initial Q Delay(d3),s/veh	0.0	0.0	0.0	0.0	0.0	0.0	0.0	0.0	0.0	0.0	0.0	0.0
%ile BackOfQ(50%),veh/ln	4.6	0.0	1.2	0.8	0.0	2.6	7.7	3.6	0.2	0.6	4.5	1.0
Unsig. Movement Delay, s/veh												
LnGrp Delay(d),s/veh	29.5	0.0	24.6	29.1	0.0	33.2	41.3	15.8	12.9	34.8	29.7	23.9
LnGrp LOS	C	A	C	C	A	C	D	B	B	C	C	C
Approach Vol, veh/h		641			201			1060			671	
Approach Delay, s/veh		28.9			32.1			24.9			29.3	
Approach LOS		C			C			C			C	
Timer - Assigned Phs		2	3	4		6	7	8				
Phs Duration (G+Y+Rc), s		18.6	21.9	19.2		12.8	7.3	33.7				
Change Period (Y+Rc), s		5.1	5.1	5.4		5.1	5.4	* 5.4				
Max Green Setting (Gmax), s		18.0	17.0	16.0		10.0	10.0	* 24				
Max Q Clear Time (g_c+I1), s		12.7	16.8	12.8		7.7	3.3	11.9				
Green Ext Time (p_c), s		0.5	0.0	0.7		0.1	0.0	1.9				

### Intersection Summary

HCM 6th Ctrl Delay	27.6
HCM 6th LOS	C

### Notes

- User approved pedestrian interval to be less than phase max green.
- User approved volume balancing among the lanes for turning movement.
- \* HCM 6th computational engine requires equal clearance times for the phases crossing the barrier.

HCM 6th AWSC  
 15: Arnold Dr & Warm Springs Rd/Private Dwy

Existing Conditions PM

Intersection

Intersection Delay, s/veh	11
Intersection LOS	B

Movement	EBL	EBT	EBR	WBL	WBT	WBR	NBL	NBT	NBR	SBL	SBT	SBR
Lane Configurations		↕			↕			↕			↕	
Traffic Vol, veh/h	50	10	190	10	10	10	130	150	10	10	120	60
Future Vol, veh/h	50	10	190	10	10	10	130	150	10	10	120	60
Peak Hour Factor	0.92	0.92	0.92	0.92	0.92	0.92	0.92	0.92	0.92	0.92	0.92	0.92
Heavy Vehicles, %	2	2	2	2	2	2	2	2	2	2	2	2
Mvmt Flow	54	11	207	11	11	11	141	163	11	11	130	65
Number of Lanes	0	1	0	0	1	0	0	1	0	0	1	0

Approach	EB	WB	NB	SB
Opposing Approach	WB	EB	SB	NB
Opposing Lanes	1	1	1	1
Conflicting Approach Left	SB	NB	EB	WB
Conflicting Lanes Left	1	1	1	1
Conflicting Approach Right	NB	SB	WB	EB
Conflicting Lanes Right	1	1	1	1
HCM Control Delay	10.7	8.9	12	10
HCM LOS	B	A	B	A

Lane	NBLn1	EBLn1	WBLn1	SBLn1
Vol Left, %	45%	20%	33%	5%
Vol Thru, %	52%	4%	33%	63%
Vol Right, %	3%	76%	33%	32%
Sign Control	Stop	Stop	Stop	Stop
Traffic Vol by Lane	290	250	30	190
LT Vol	130	50	10	10
Through Vol	150	10	10	120
RT Vol	10	190	10	60
Lane Flow Rate	315	272	33	207
Geometry Grp	1	1	1	1
Degree of Util (X)	0.438	0.363	0.051	0.287
Departure Headway (Hd)	5.001	4.814	5.582	5.004
Convergence, Y/N	Yes	Yes	Yes	Yes
Cap	709	736	644	723
Service Time	3.099	2.912	3.594	3.004
HCM Lane V/C Ratio	0.444	0.37	0.051	0.286
HCM Control Delay	12	10.7	8.9	10
HCM Lane LOS	B	B	A	A
HCM 95th-tile Q	2.2	1.7	0.2	1.2

HCM 6th TWSC  
16: Riverside Dr & Verano Ave

Existing Conditions PM

Intersection												
Int Delay, s/veh	31.3											
Movement	EBL	EBT	EBR	WBL	WBT	WBR	NBL	NBT	NBR	SBL	SBT	SBR
Lane Configurations												
Traffic Vol, veh/h	50	290	110	70	350	130	20	80	20	70	50	30
Future Vol, veh/h	50	290	110	70	350	130	20	80	20	70	50	30
Conflicting Peds, #/hr	0	0	0	0	0	0	0	0	0	0	0	0
Sign Control	Free	Free	Free	Free	Free	Free	Stop	Stop	Stop	Stop	Stop	Stop
RT Channelized	-	-	None	-	-	None	-	-	None	-	-	None
Storage Length	100	-	-	-	-	-	-	-	-	-	-	-
Veh in Median Storage, #	-	0	-	-	0	-	-	0	-	-	0	-
Grade, %	-	0	-	-	0	-	-	0	-	-	0	-
Peak Hour Factor	92	92	92	92	92	92	92	92	92	92	92	92
Heavy Vehicles, %	2	2	2	2	2	2	2	2	2	2	2	2
Mvmt Flow	54	315	120	76	380	141	22	87	22	76	54	33

Major/Minor	Major1			Major2			Minor1			Minor2		
Conflicting Flow All	521	0	0	435	0	0	1129	1156	375	1141	1146	451
Stage 1	-	-	-	-	-	-	483	483	-	603	603	-
Stage 2	-	-	-	-	-	-	646	673	-	538	543	-
Critical Hdwy	4.12	-	-	4.12	-	-	7.12	6.52	6.22	7.12	6.52	6.22
Critical Hdwy Stg 1	-	-	-	-	-	-	6.12	5.52	-	6.12	5.52	-
Critical Hdwy Stg 2	-	-	-	-	-	-	6.12	5.52	-	6.12	5.52	-
Follow-up Hdwy	2.218	-	-	2.218	-	-	3.518	4.018	3.318	3.518	4.018	3.318
Pot Cap-1 Maneuver	1045	-	-	1125	-	-	181	197	671	178	199	608
Stage 1	-	-	-	-	-	-	565	553	-	486	488	-
Stage 2	-	-	-	-	-	-	460	454	-	527	520	-
Platoon blocked, %	-	-	-	-	-	-	-	-	-	-	-	-
Mov Cap-1 Maneuver	1045	-	-	1125	-	-	115	169	671	92	170	608
Mov Cap-2 Maneuver	-	-	-	-	-	-	115	169	-	92	170	-
Stage 1	-	-	-	-	-	-	536	524	-	461	441	-
Stage 2	-	-	-	-	-	-	345	410	-	403	493	-

Approach	EB			WB			NB			SB		
HCM Control Delay, s	1			1.1			67.4			203.8		
HCM LOS							F			F		

Minor Lane/Major Mvmt	NBLn1	EBL	EBT	EBR	WBL	WBT	WBR	SBLn1
Capacity (veh/h)	177	1045	-	-	1125	-	-	136
HCM Lane V/C Ratio	0.737	0.052	-	-	0.068	-	-	1.199
HCM Control Delay (s)	67.4	8.6	-	-	8.4	0	-	203.8
HCM Lane LOS	F	A	-	-	A	A	-	F
HCM 95th %tile Q(veh)	4.7	0.2	-	-	0.2	-	-	9.7

HCM 6th Signalized Intersection Summary  
 17: Main St/Petaluma Hill Rd & Old Adobe Rd/Adobe Rd

Existing Conditions PM



Movement	EBL	EBT	EBR	WBL	WBT	WBR	NBL	NBT	NBR	SBL	SBT	SBR
Lane Configurations		↕			↕			↕		↕	↕	↕
Traffic Volume (veh/h)	30	130	50	20	180	390	40	630	20	260	280	30
Future Volume (veh/h)	30	130	50	20	180	390	40	630	20	260	280	30
Initial Q (Qb), veh	0	0	0	0	0	0	0	0	0	0	0	0
Ped-Bike Adj(A_pbT)	1.00		0.99	1.00		0.99	1.00		1.00	1.00		0.99
Parking Bus, Adj	1.00	1.00	1.00	1.00	1.00	1.00	1.00	1.00	1.00	1.00	1.00	1.00
Work Zone On Approach		No			No			No			No	
Adj Sat Flow, veh/h/ln	1870	1870	1870	1870	1870	1870	1870	1870	1870	1870	1870	1870
Adj Flow Rate, veh/h	33	141	39	22	196	328	43	685	21	283	304	28
Peak Hour Factor	0.92	0.92	0.92	0.92	0.92	0.92	0.92	0.92	0.92	0.92	0.92	0.92
Percent Heavy Veh, %	2	2	2	2	2	2	2	2	2	2	2	2
Cap, veh/h	106	409	103	63	231	367	28	451	14	365	345	32
Arrive On Green	0.36	0.36	0.35	0.37	0.37	0.35	0.27	0.27	0.26	0.20	0.20	0.19
Sat Flow, veh/h	138	1127	284	34	630	999	107	1697	52	1781	1685	155
Grp Volume(v), veh/h	213	0	0	546	0	0	749	0	0	283	0	332
Grp Sat Flow(s),veh/h/ln	1549	0	0	1663	0	0	1856	0	0	1781	0	1840
Q Serve(g_s), s	0.0	0.0	0.0	9.6	0.0	0.0	19.6	0.0	0.0	11.1	0.0	12.9
Cycle Q Clear(g_c), s	6.3	0.0	0.0	22.8	0.0	0.0	19.6	0.0	0.0	11.1	0.0	12.9
Prop In Lane	0.15		0.18	0.04		0.60	0.06		0.03	1.00		0.08
Lane Grp Cap(c), veh/h	618	0	0	661	0	0	493	0	0	365	0	377
V/C Ratio(X)	0.34	0.00	0.00	0.83	0.00	0.00	1.52	0.00	0.00	0.78	0.00	0.88
Avail Cap(c_a), veh/h	618	0	0	729	0	0	493	0	0	365	0	377
HCM Platoon Ratio	1.00	1.00	1.00	1.00	1.00	1.00	1.00	1.00	1.00	1.00	1.00	1.00
Upstream Filter(I)	1.00	0.00	0.00	1.00	0.00	0.00	1.00	0.00	0.00	1.00	0.00	1.00
Uniform Delay (d), s/veh	17.1	0.0	0.0	22.4	0.0	0.0	27.1	0.0	0.0	27.7	0.0	28.5
Incr Delay (d2), s/veh	0.1	0.0	0.0	6.4	0.0	0.0	243.8	0.0	0.0	9.2	0.0	20.2
Initial Q Delay(d3),s/veh	0.0	0.0	0.0	0.0	0.0	0.0	0.0	0.0	0.0	0.0	0.0	0.0
%ile BackOfQ(50%),veh/ln	2.4	0.0	0.0	9.2	0.0	0.0	41.7	0.0	0.0	5.4	0.0	7.5
Unsig. Movement Delay, s/veh												
LnGrp Delay(d),s/veh	17.2	0.0	0.0	28.8	0.0	0.0	270.9	0.0	0.0	37.0	0.0	48.7
LnGrp LOS	B	A	A	C	A	A	F	A	A	D	A	D
Approach Vol, veh/h		213			546			749				615
Approach Delay, s/veh		17.2			28.8			270.9				43.3
Approach LOS		B			C			F				D
Timer - Assigned Phs		2		4		6		8				
Phs Duration (G+Y+Rc), s		23.6		31.1		19.1		31.1				
Change Period (Y+Rc), s		4.6		* 5.4		5.4		5.4				
Max Green Setting (Gmax), s		19.0		* 24		13.7		28.7				
Max Q Clear Time (g_c+I1), s		21.6		8.3		14.9		24.8				
Green Ext Time (p_c), s		0.0		0.4		0.0		0.6				

Intersection Summary

HCM 6th Ctrl Delay	117.2
HCM 6th LOS	F

Notes

- User approved pedestrian interval to be less than phase max green.
- \* HCM 6th computational engine requires equal clearance times for the phases crossing the barrier.

# HCM 6th Signalized Intersection Summary

## 18: Old Redwood Hwy & Main St

Existing Conditions PM



Movement	WBL	WBR	NBT	NBR	SBL	SBT
Lane Configurations						
Traffic Volume (veh/h)	320	20	520	670	20	240
Future Volume (veh/h)	320	20	520	670	20	240
Initial Q (Qb), veh	0	0	0	0	0	0
Ped-Bike Adj(A_pbT)	1.00	1.00		1.00	1.00	
Parking Bus, Adj	1.00	1.00	1.00	1.00	1.00	1.00
Work Zone On Approach	No		No		No	
Adj Sat Flow, veh/h/ln	1870	1870	1870	1870	1870	1870
Adj Flow Rate, veh/h	348	5	565	728	22	261
Peak Hour Factor	0.92	0.92	0.92	0.92	0.92	0.92
Percent Heavy Veh, %	2	2	2	2	2	2
Cap, veh/h	414	369	945	801	103	1181
Arrive On Green	0.23	0.23	0.51	0.51	0.06	0.63
Sat Flow, veh/h	1781	1585	1870	1585	1781	1870
Grp Volume(v), veh/h	348	5	565	728	22	261
Grp Sat Flow(s),veh/h/ln	1781	1585	1870	1585	1781	1870
Q Serve(g_s), s	11.0	0.1	12.6	24.7	0.7	3.5
Cycle Q Clear(g_c), s	11.0	0.1	12.6	24.7	0.7	3.5
Prop In Lane	1.00	1.00		1.00	1.00	
Lane Grp Cap(c), veh/h	414	369	945	801	103	1181
V/C Ratio(X)	0.84	0.01	0.60	0.91	0.21	0.22
Avail Cap(c_a), veh/h	927	825	1025	868	430	1181
HCM Platoon Ratio	1.00	1.00	1.00	1.00	1.00	1.00
Upstream Filter(I)	1.00	1.00	1.00	1.00	1.00	1.00
Uniform Delay (d), s/veh	21.5	17.4	10.3	13.3	26.4	4.6
Incr Delay (d2), s/veh	1.8	0.0	0.5	12.2	0.4	0.0
Initial Q Delay(d3),s/veh	0.0	0.0	0.0	0.0	0.0	0.0
%ile BackOfQ(50%),veh/ln	11.5	0.1	4.0	9.1	0.3	0.8
Unsig. Movement Delay, s/veh						
LnGrp Delay(d),s/veh	23.3	17.4	10.8	25.5	26.8	4.7
LnGrp LOS	C	B	B	C	C	A
Approach Vol, veh/h	353		1293			283
Approach Delay, s/veh	23.2		19.0			6.4
Approach LOS	C		B			A
Timer - Assigned Phs	1	2		4		6
Phs Duration (G+Y+Rc), s	7.4	33.7		17.7		41.1
Change Period (Y+Rc), s	6.2	6.2		4.6		6.2
Max Green Setting (Gmax), s	30.0	30.0		30.0		30.0
Max Q Clear Time (g_c+1), s	26.7	26.7		13.0		5.5
Green Ext Time (p_c), s	0.0	0.8		0.2		0.4

### Intersection Summary

HCM 6th Ctrl Delay	18.0
HCM 6th LOS	B

### Notes

User approved pedestrian interval to be less than phase max green.

HCM 6th TWSC  
 19: Private Dwy/Paula Ln & Bodega Ave

Existing Conditions PM

Intersection												
Int Delay, s/veh	1											
Movement	EBL	EBT	EBR	WBL	WBT	WBR	NBL	NBT	NBR	SBL	SBT	SBR
Lane Configurations	↖	↗		↖	↗			↕			↕	
Traffic Vol, veh/h	20	350	0	0	420	20	0	0	0	20	0	20
Future Vol, veh/h	20	350	0	0	420	20	0	0	0	20	0	20
Conflicting Peds, #/hr	0	0	0	0	0	0	0	0	0	0	0	0
Sign Control	Free	Free	Free	Free	Free	Free	Stop	Stop	Stop	Stop	Stop	Stop
RT Channelized	-	-	None	-	-	None	-	-	None	-	-	None
Storage Length	90	-	-	90	-	-	-	-	-	-	-	-
Veh in Median Storage, #	-	0	-	-	0	-	-	0	-	-	0	-
Grade, %	-	0	-	-	0	-	-	0	-	-	0	-
Peak Hour Factor	92	92	92	92	92	92	92	92	92	92	92	92
Heavy Vehicles, %	2	2	2	2	2	2	2	2	2	2	2	2
Mvmt Flow	22	380	0	0	457	22	0	0	0	22	0	22

Major/Minor	Major1			Major2			Minor1			Minor2		
Conflicting Flow All	479	0	0	380	0	0	903	903	380	892	892	468
Stage 1	-	-	-	-	-	-	424	424	-	468	468	-
Stage 2	-	-	-	-	-	-	479	479	-	424	424	-
Critical Hdwy	4.12	-	-	4.12	-	-	7.12	6.52	6.22	7.12	6.52	6.22
Critical Hdwy Stg 1	-	-	-	-	-	-	6.12	5.52	-	6.12	5.52	-
Critical Hdwy Stg 2	-	-	-	-	-	-	6.12	5.52	-	6.12	5.52	-
Follow-up Hdwy	2.218	-	-	2.218	-	-	3.518	4.018	3.318	3.518	4.018	3.318
Pot Cap-1 Maneuver	1083	-	-	1178	-	-	258	277	667	263	281	595
Stage 1	-	-	-	-	-	-	608	587	-	575	561	-
Stage 2	-	-	-	-	-	-	568	555	-	608	587	-
Platoon blocked, %	-	-	-	-	-	-	-	-	-	-	-	-
Mov Cap-1 Maneuver	1083	-	-	1178	-	-	245	271	667	259	275	595
Mov Cap-2 Maneuver	-	-	-	-	-	-	245	271	-	259	275	-
Stage 1	-	-	-	-	-	-	596	575	-	564	561	-
Stage 2	-	-	-	-	-	-	547	555	-	596	575	-

Approach	EB	WB	NB	SB
HCM Control Delay, s	0.5	0	0	16.3
HCM LOS			A	C

Minor Lane/Major Mvmt	NBLn1	EBL	EBT	EBR	WBL	WBT	WBR	SBLn1
Capacity (veh/h)	-	1083	-	-	1178	-	-	361
HCM Lane V/C Ratio	-	0.02	-	-	-	-	-	0.12
HCM Control Delay (s)	0	8.4	-	-	0	-	-	16.3
HCM Lane LOS	A	A	-	-	A	-	-	C
HCM 95th %tile Q(veh)	-	0.1	-	-	0	-	-	0.4

HCM 6th Signalized Intersection Summary  
 20: Broadway & Leveroni Rd/Napa Rd

Existing Conditions PM

Movement	EBL	EBT	EBR	WBL	WBT	WBR	NBL	NBT	NBR	SBL	SBT	SBR
Lane Configurations												
Traffic Volume (veh/h)	110	350	60	70	380	240	70	250	100	240	260	110
Future Volume (veh/h)	110	350	60	70	380	240	70	250	100	240	260	110
Initial Q (Qb), veh	0	0	0	0	0	0	0	0	0	0	0	0
Ped-Bike Adj(A_pbT)	1.00		1.00	1.00		1.00	1.00		0.98	1.00		0.99
Parking Bus, Adj	1.00	1.00	1.00	1.00	1.00	1.00	1.00	1.00	1.00	1.00	1.00	1.00
Work Zone On Approach		No			No			No			No	
Adj Sat Flow, veh/h/ln	1870	1870	1870	1870	1870	1870	1870	1870	1870	1870	1870	1870
Adj Flow Rate, veh/h	120	380	61	76	413	244	76	272	70	261	283	79
Peak Hour Factor	0.92	0.92	0.92	0.92	0.92	0.92	0.92	0.92	0.92	0.92	0.92	0.92
Percent Heavy Veh, %	2	2	2	2	2	2	2	2	2	2	2	2
Cap, veh/h	216	595	96	191	401	237	191	446	112	299	603	165
Arrive On Green	0.12	0.38	0.38	0.11	0.36	0.36	0.11	0.16	0.15	0.17	0.22	0.21
Sat Flow, veh/h	1781	1571	252	1781	1100	650	1781	2800	706	1781	2749	752
Grp Volume(v), veh/h	120	0	441	76	0	657	76	171	171	261	181	181
Grp Sat Flow(s),veh/h/ln	1781	0	1824	1781	0	1750	1781	1777	1729	1781	1777	1724
Q Serve(g_s), s	5.4	0.0	16.9	3.4	0.0	31.2	3.4	7.6	7.9	12.2	7.6	7.9
Cycle Q Clear(g_c), s	5.4	0.0	16.9	3.4	0.0	31.2	3.4	7.6	7.9	12.2	7.6	7.9
Prop In Lane	1.00		0.14	1.00		0.37	1.00		0.41	1.00		0.44
Lane Grp Cap(c), veh/h	216	0	691	191	0	639	191	283	275	299	390	378
V/C Ratio(X)	0.56	0.00	0.64	0.40	0.00	1.03	0.40	0.60	0.62	0.87	0.46	0.48
Avail Cap(c_a), veh/h	542	0	691	542	0	639	229	582	566	333	582	565
HCM Platoon Ratio	1.00	1.00	1.00	1.00	1.00	1.00	1.00	1.00	1.00	1.00	1.00	1.00
Upstream Filter(I)	1.00	0.00	1.00	1.00	0.00	1.00	1.00	1.00	1.00	1.00	1.00	1.00
Uniform Delay (d), s/veh	35.4	0.0	21.8	35.6	0.0	27.2	35.6	33.4	33.8	34.7	29.0	29.3
Incr Delay (d2), s/veh	2.2	0.0	2.0	1.3	0.0	43.2	1.3	2.1	2.3	20.3	0.9	0.9
Initial Q Delay(d3),s/veh	0.0	0.0	0.0	0.0	0.0	0.0	0.0	0.0	0.0	0.0	0.0	0.0
%ile BackOfQ(50%),veh/ln	2.4	0.0	6.9	1.5	0.0	19.5	1.5	3.3	3.3	6.8	3.2	3.2
Unsig. Movement Delay, s/veh												
LnGrp Delay(d),s/veh	37.6	0.0	23.8	36.9	0.0	70.4	36.9	35.5	36.1	55.0	29.9	30.3
LnGrp LOS	D	A	C	D	A	F	D	D	D	E	C	C
Approach Vol, veh/h		561			733			418			623	
Approach Delay, s/veh		26.7			66.9			36.0			40.5	
Approach LOS		C			E			D			D	
Timer - Assigned Phs	1	2	3	4	5	6	7	8				
Phs Duration (G+Y+Rc), s	13.2	22.7	14.4	35.2	18.3	17.6	13.2	36.4				
Change Period (Y+Rc), s	4.0	5.0	4.0	* 4.2	4.0	5.0	4.0	* 4.2				
Max Green Setting (Gmax), s	11.0	27.0	26.0	* 31	16.0	27.0	26.0	* 31				
Max Q Clear Time (g_c+I1), s	5.4	9.9	7.4	33.2	14.2	9.9	5.4	18.9				
Green Ext Time (p_c), s	0.1	1.9	0.3	0.0	0.1	1.6	0.1	2.0				
<b>Intersection Summary</b>												
HCM 6th Ctrl Delay			44.7									
HCM 6th LOS			D									
<b>Notes</b>												
* HCM 6th computational engine requires equal clearance times for the phases crossing the barrier.												



**ATTACHMENT C-2**

**EXISTING PLUS PROGRAM CONDITIONS OUTPUTS**



HCM 6th AWSC  
 1: Geyserville Ave & Canyon Road

Existing plus Project Conditions AM

Intersection	
Intersection Delay, s/veh	8.6
Intersection LOS	A

Movement	EBL	EBT	EBR	WBL	WBT	WBR	NBL	NBT	NBR	SBL	SBT	SBR
Lane Configurations		↕			↕			↕			↕	
Traffic Vol, veh/h	40	10	178	10	10	10	118	20	10	10	20	20
Future Vol, veh/h	40	10	178	10	10	10	118	20	10	10	20	20
Peak Hour Factor	0.92	0.92	0.92	0.92	0.92	0.92	0.92	0.92	0.92	0.92	0.92	0.92
Heavy Vehicles, %	2	2	2	2	2	2	2	2	2	2	2	2
Mvmt Flow	43	11	193	11	11	11	128	22	11	11	22	22
Number of Lanes	0	1	0	0	1	0	0	1	0	0	1	0

Approach	EB	WB	NB	SB
Opposing Approach	WB	EB	SB	NB
Opposing Lanes	1	1	1	1
Conflicting Approach Left	SB	NB	EB	WB
Conflicting Lanes Left	1	1	1	1
Conflicting Approach Right	NB	SB	WB	EB
Conflicting Lanes Right	1	1	1	1
HCM Control Delay	8.6	7.8	9	7.9
HCM LOS	A	A	A	A

Lane	NBLn1	EBLn1	WBLn1	SBLn1
Vol Left, %	80%	18%	33%	20%
Vol Thru, %	14%	4%	33%	40%
Vol Right, %	7%	78%	33%	40%
Sign Control	Stop	Stop	Stop	Stop
Traffic Vol by Lane	148	228	30	50
LT Vol	118	40	10	10
Through Vol	20	10	10	20
RT Vol	10	178	10	20
Lane Flow Rate	161	248	33	54
Geometry Grp	1	1	1	1
Degree of Util (X)	0.211	0.279	0.041	0.068
Departure Headway (Hd)	4.715	4.059	4.58	4.529
Convergence, Y/N	Yes	Yes	Yes	Yes
Cap	763	887	782	790
Service Time	2.74	2.075	2.607	2.559
HCM Lane V/C Ratio	0.211	0.28	0.042	0.068
HCM Control Delay	9	8.6	7.8	7.9
HCM Lane LOS	A	A	A	A
HCM 95th-tile Q	0.8	1.1	0.1	0.2

# HCM 6th Signalized Intersection Summary

## 2: Armstrong Woods Rd & River Rd

Existing plus Project Conditions AM



Movement	EBL	EBT	EBR	WBL	WBT	WBR	NBL	NBT	NBR	SBL	SBT	SBR
Lane Configurations												
Traffic Volume (veh/h)	55	300	0	0	310	98	10	22	20	154	0	40
Future Volume (veh/h)	55	300	0	0	310	98	10	22	20	154	0	40
Initial Q (Qb), veh	0	0	0	0	0	0	0	0	0	0	0	0
Ped-Bike Adj(A_pbT)	1.00		1.00	1.00		0.99	0.99		0.99	0.99		0.99
Parking Bus, Adj	1.00	1.00	1.00	1.00	1.00	1.00	1.00	1.00	1.00	1.00	1.00	1.00
Work Zone On Approach	No				No				No			
Adj Sat Flow, veh/h/ln	1870	1870	0	0	1870	1870	1870	1870	1870	1870	1870	1870
Adj Flow Rate, veh/h	60	326	0	0	337	44	11	24	5	167	0	9
Peak Hour Factor	0.92	0.92	0.92	0.92	0.92	0.92	0.92	0.92	0.92	0.92	0.92	0.92
Percent Heavy Veh, %	2	2	0	0	2	2	2	2	2	2	2	2
Cap, veh/h	501	965	0	0	549	461	499	323	67	483	0	338
Arrive On Green	0.09	0.52	0.00	0.00	0.29	0.29	0.22	0.22	0.22	0.22	0.00	0.22
Sat Flow, veh/h	1781	1870	0	0	1870	1572	1390	1498	312	1366	0	1568
Grp Volume(v), veh/h	60	326	0	0	337	44	11	0	29	167	0	9
Grp Sat Flow(s),veh/h/ln	1781	1870	0	0	1870	1572	1390	0	1810	1366	0	1568
Q Serve(g_s), s	0.7	3.6	0.0	0.0	5.4	0.7	0.2	0.0	0.4	3.9	0.0	0.2
Cycle Q Clear(g_c), s	0.7	3.6	0.0	0.0	5.4	0.7	0.4	0.0	0.4	4.3	0.0	0.2
Prop In Lane	1.00		0.00	0.00		1.00	1.00		0.17	1.00		1.00
Lane Grp Cap(c), veh/h	501	965	0	0	549	461	499	0	390	483	0	338
V/C Ratio(X)	0.12	0.34	0.00	0.00	0.61	0.10	0.02	0.00	0.07	0.35	0.00	0.03
Avail Cap(c_a), veh/h	700	1709	0	0	2243	1884	914	0	930	890	0	806
HCM Platoon Ratio	1.00	1.00	1.00	1.00	1.00	1.00	1.00	1.00	1.00	1.00	1.00	1.00
Upstream Filter(I)	1.00	1.00	0.00	0.00	1.00	1.00	1.00	0.00	1.00	1.00	0.00	1.00
Uniform Delay (d), s/veh	6.5	5.0	0.0	0.0	10.7	9.0	11.0	0.0	11.0	12.7	0.0	10.8
Incr Delay (d2), s/veh	0.1	0.2	0.0	0.0	1.1	0.1	0.0	0.0	0.1	0.4	0.0	0.0
Initial Q Delay(d3),s/veh	0.0	0.0	0.0	0.0	0.0	0.0	0.0	0.0	0.0	0.0	0.0	0.0
%ile BackOfQ(50%),veh/ln	0.2	0.9	0.0	0.0	1.9	0.2	0.1	0.0	0.2	1.0	0.0	0.0
Unsig. Movement Delay, s/veh												
LnGrp Delay(d),s/veh	6.7	5.2	0.0	0.0	11.8	9.1	11.0	0.0	11.0	13.1	0.0	10.9
LnGrp LOS	A	A	A	A	B	A	B	A	B	B	A	B
Approach Vol, veh/h	386				381				40		176	
Approach Delay, s/veh	5.4				11.5				11.0		13.0	
Approach LOS	A				B				B		B	
Timer - Assigned Phs	2		4		5		6		8			
Phs Duration (G+Y+Rc), s	22.8		12.3		7.8		15.0		12.3			
Change Period (Y+Rc), s	* 4.7		* 4.7		* 4.7		* 4.7		* 4.7			
Max Green Setting (Gmax), s	* 32		* 18		* 7		* 42		* 18			
Max Q Clear Time (g_c+I1), s	5.6		6.3		2.7		7.4		2.4			
Green Ext Time (p_c), s	2.1		0.4		0.0		2.5		0.1			

### Intersection Summary

HCM 6th Ctrl Delay	9.3
HCM 6th LOS	A

### Notes

- User approved pedestrian interval to be less than phase max green.
- \* HCM 6th computational engine requires equal clearance times for the phases crossing the barrier.

# HCM 6th Signalized Intersection Summary

## 3: Gravenstein Hwy/Old River Rd & River Rd

Existing plus Project Conditions AM



Movement	EBL	EBT	EBR	WBL	WBT	WBR	NBL	NBT	NBR	SBL	SBT	SBR
Lane Configurations		↑	↗	↖	↗	↖	↗	↖			↕	
Traffic Volume (veh/h)	0	335	139	20	290	10	108	30	70	10	20	10
Future Volume (veh/h)	0	335	139	20	290	10	108	30	70	10	20	10
Initial Q (Qb), veh	0	0	0	0	0	0	0	0	0	0	0	0
Ped-Bike Adj(A_pbT)	1.00		0.99	1.00		0.99	0.99		1.00	1.00		0.99
Parking Bus, Adj	1.00	1.00	1.00	1.00	1.00	1.00	1.00	1.00	1.00	1.00	1.00	1.00
Work Zone On Approach		No			No			No			No	
Adj Sat Flow, veh/h/ln	0	1870	1870	1870	1870	1870	1870	1870	1870	1870	1870	1870
Adj Flow Rate, veh/h	0	364	97	22	315	10	117	33	16	11	22	2
Peak Hour Factor	0.92	0.92	0.92	0.92	0.92	0.92	0.92	0.92	0.92	0.92	0.92	0.92
Percent Heavy Veh, %	0	2	2	2	2	2	2	2	2	2	2	2
Cap, veh/h	0	578	486	432	896	28	529	270	131	206	305	23
Arrive On Green	0.00	0.31	0.31	0.05	0.50	0.50	0.23	0.23	0.23	0.23	0.23	0.23
Sat Flow, veh/h	0	1870	1572	1781	1802	57	1373	1190	577	294	1346	99
Grp Volume(v), veh/h	0	364	97	22	0	325	117	0	49	35	0	0
Grp Sat Flow(s),veh/h/ln	0	1870	1572	1781	0	1860	1373	0	1767	1740	0	0
Q Serve(g_s), s	0.0	5.7	1.5	0.2	0.0	3.6	1.8	0.0	0.8	0.0	0.0	0.0
Cycle Q Clear(g_c), s	0.0	5.7	1.5	0.2	0.0	3.6	2.3	0.0	0.8	0.5	0.0	0.0
Prop In Lane	0.00		1.00	1.00		0.03	1.00		0.33	0.31		0.06
Lane Grp Cap(c), veh/h	0	578	486	432	0	924	529	0	400	533	0	0
V/C Ratio(X)	0.00	0.63	0.20	0.05	0.00	0.35	0.22	0.00	0.12	0.07	0.00	0.00
Avail Cap(c_a), veh/h	0	1320	1110	815	0	1313	1429	0	1559	645	0	0
HCM Platoon Ratio	1.00	1.00	1.00	1.00	1.00	1.00	1.00	1.00	1.00	1.00	1.00	1.00
Upstream Filter(I)	0.00	1.00	1.00	1.00	0.00	1.00	1.00	0.00	1.00	1.00	0.00	0.00
Uniform Delay (d), s/veh	0.0	10.1	8.7	6.7	0.0	5.2	11.0	0.0	10.5	10.4	0.0	0.0
Incr Delay (d2), s/veh	0.0	1.1	0.2	0.0	0.0	0.2	0.2	0.0	0.1	0.1	0.0	0.0
Initial Q Delay(d3),s/veh	0.0	0.0	0.0	0.0	0.0	0.0	0.0	0.0	0.0	0.0	0.0	0.0
%ile BackOfQ(50%),veh/ln	0.0	1.9	0.4	0.1	0.0	0.9	0.6	0.0	0.2	0.2	0.0	0.0
Unsig. Movement Delay, s/veh												
LnGrp Delay(d),s/veh	0.0	11.2	8.9	6.8	0.0	5.4	11.2	0.0	10.6	10.4	0.0	0.0
LnGrp LOS	A	B	A	A	A	A	B	A	B	B	A	A
Approach Vol, veh/h		461			347			166				35
Approach Delay, s/veh		10.7			5.5			11.0				10.4
Approach LOS		B			A			B				B
Timer - Assigned Phs	1	2		4		6		8				
Phs Duration (G+Y+Rc), s	6.4	15.2		12.4		21.6		12.4				
Change Period (Y+Rc), s	4.7	* 4.7		* 4.7		* 4.7		* 4.7				
Max Green Setting (Gmax), s	24	* 24		* 10		* 24		* 30				
Max Q Clear Time (g_c+1/2), s	7.7	7.7		2.5		5.6		4.3				
Green Ext Time (p_c), s	0.0	2.4		0.0		1.9		0.6				

### Intersection Summary

HCM 6th Ctrl Delay	9.0
HCM 6th LOS	A

### Notes

User approved pedestrian interval to be less than phase max green.  
 \* HCM 6th computational engine requires equal clearance times for the phases crossing the barrier.

HCM 6th TWSC  
4: Old Redwood Hwy & Fulton Rd

Existing plus Project Conditions AM

Intersection						
Int Delay, s/veh	3.7					
Movement	EBL	EBR	NBL	NBT	SBT	SBR
Lane Configurations	↘	↗	↘	↗	↗	↗
Traffic Vol, veh/h	132	30	30	144	656	308
Future Vol, veh/h	132	30	30	144	656	308
Conflicting Peds, #/hr	0	0	0	0	0	0
Sign Control	Stop	Stop	Free	Free	Free	Free
RT Channelized	-	Stop	-	None	-	None
Storage Length	0	90	70	-	-	100
Veh in Median Storage, #	0	-	-	0	0	-
Grade, %	0	-	-	0	0	-
Peak Hour Factor	92	92	92	92	92	92
Heavy Vehicles, %	2	2	2	2	2	2
Mvmt Flow	143	33	33	157	713	335























Major/Minor	Minor2	Major1	Major2			
Conflicting Flow All	936	713	1048	0	-	0
Stage 1	713	-	-	-	-	-
Stage 2	223	-	-	-	-	-
Critical Hdwy	6.42	6.22	4.12	-	-	-
Critical Hdwy Stg 1	5.42	-	-	-	-	-
Critical Hdwy Stg 2	5.42	-	-	-	-	-
Follow-up Hdwy	3.518	3.318	2.218	-	-	-
Pot Cap-1 Maneuver	294	432	664	-	-	-
Stage 1	486	-	-	-	-	-
Stage 2	814	-	-	-	-	-
Platoon blocked, %				-	-	-
Mov Cap-1 Maneuver	279	432	664	-	-	-
Mov Cap-2 Maneuver	279	-	-	-	-	-
Stage 1	462	-	-	-	-	-
Stage 2	814	-	-	-	-	-

Approach	EB	NB	SB
HCM Control Delay, s	27.7	1.8	0
HCM LOS	D		

Minor Lane/Major Mvmt	NBL	NBT	EBLn1	EBLn2	SBT	SBR
Capacity (veh/h)	664	-	279	432	-	-
HCM Lane V/C Ratio	0.049	-	0.514	0.075	-	-
HCM Control Delay (s)	10.7	-	30.8	14	-	-
HCM Lane LOS	B	-	D	B	-	-
HCM 95th %tile Q(veh)	0.2	-	2.7	0.2	-	-

HCM 6th Signalized Intersection Summary  
 5: Fulton Rd & Airport Blvd

Existing plus Project Conditions AM

												
Movement	EBL	EBT	EBR	WBL	WBT	WBR	NBL	NBT	NBR	SBL	SBT	SBR
Lane Configurations												
Traffic Volume (veh/h)	61	271	160	182	493	20	570	141	121	30	222	206
Future Volume (veh/h)	61	271	160	182	493	20	570	141	121	30	222	206
Initial Q (Qb), veh	0	0	0	0	0	0	0	0	0	0	0	0
Ped-Bike Adj(A_pbT)	1.00		0.99	1.00		0.99	1.00		0.99	1.00		0.99
Parking Bus, Adj	1.00	1.00	1.00	1.00	1.00	1.00	1.00	1.00	1.00	1.00	1.00	1.00
Work Zone On Approach		No			No			No			No	
Adj Sat Flow, veh/h/ln	1870	1870	1870	1870	1870	1870	1870	1870	1870	1870	1870	1870
Adj Flow Rate, veh/h	66	295	38	198	536	21	620	153	35	33	241	201
Peak Hour Factor	0.92	0.92	0.92	0.92	0.92	0.92	0.92	0.92	0.92	0.92	0.92	0.92
Percent Heavy Veh, %	2	2	2	2	2	2	2	2	2	2	2	2
Cap, veh/h	85	376	315	229	497	19	495	520	437	22	162	135
Arrive On Green	0.05	0.20	0.20	0.13	0.28	0.28	0.28	0.28	0.28	0.19	0.19	0.19
Sat Flow, veh/h	1781	1870	1565	1781	1787	70	1781	1870	1571	120	876	730
Grp Volume(v), veh/h	66	295	38	198	0	557	620	153	35	475	0	0
Grp Sat Flow(s),veh/h/ln	1781	1870	1565	1781	0	1857	1781	1870	1571	1726	0	0
Q Serve(g_s), s	4.0	16.1	2.1	11.8	0.0	30.0	30.0	6.9	1.8	20.0	0.0	0.0
Cycle Q Clear(g_c), s	4.0	16.1	2.1	11.8	0.0	30.0	30.0	6.9	1.8	20.0	0.0	0.0
Prop In Lane	1.00		1.00	1.00		0.04	1.00		1.00	0.07		0.42
Lane Grp Cap(c), veh/h	85	376	315	229	0	516	495	520	437	320	0	0
V/C Ratio(X)	0.77	0.78	0.12	0.87	0.00	1.08	1.25	0.29	0.08	1.48	0.00	0.00
Avail Cap(c_a), veh/h	330	520	435	330	0	516	495	520	437	320	0	0
HCM Platoon Ratio	1.00	1.00	1.00	1.00	1.00	1.00	1.00	1.00	1.00	1.00	1.00	1.00
Upstream Filter(I)	1.00	1.00	1.00	1.00	0.00	1.00	1.00	1.00	1.00	1.00	0.00	0.00
Uniform Delay (d), s/veh	50.8	40.9	35.3	46.1	0.0	38.9	38.9	30.6	28.7	43.9	0.0	0.0
Incr Delay (d2), s/veh	5.5	3.4	0.1	11.2	0.0	62.4	129.0	0.1	0.0	234.0	0.0	0.0
Initial Q Delay(d3),s/veh	0.0	0.0	0.0	0.0	0.0	0.0	0.0	0.0	0.0	0.0	0.0	0.0
%ile BackOfQ(50%),veh/ln	1.8	7.5	0.8	5.8	0.0	22.0	30.2	3.0	0.7	29.2	0.0	0.0
Unsig. Movement Delay, s/veh												
LnGrp Delay(d),s/veh	56.3	44.3	35.3	57.3	0.0	101.4	168.0	30.7	28.8	278.0	0.0	0.0
LnGrp LOS	E	D	D	E	A	F	F	C	C	F	A	A
Approach Vol, veh/h		399			755			808			475	
Approach Delay, s/veh		45.4			89.8			135.9			278.0	
Approach LOS		D			F			F			F	
Timer - Assigned Phs	1	2		4	5	6		8				
Phs Duration (G+Y+Rc), s	19.3	27.7		25.1	11.0	36.0		35.8				
Change Period (Y+Rc), s	5.4	6.0		5.1	5.8	6.0		5.8				
Max Green Setting (Gmax), s	20.0	30.0		20.0	20.0	30.0		30.0				
Max Q Clear Time (g_c+I1), s	13.8	18.1		22.0	6.0	32.0		32.0				
Green Ext Time (p_c), s	0.1	0.8		0.0	0.0	0.0		0.0				

Intersection Summary

HCM 6th Ctrl Delay	134.5
HCM 6th LOS	F

Notes

User approved pedestrian interval to be less than phase max green.

HCM 6th Signalized Intersection Summary  
 6: Old Redwood Hwy & Airport Blvd

Existing plus Project Conditions AM



Movement	EBL	EBT	EBR	WBL	WBT	WBR	NBL	NBT	NBR	SBL	SBT	SBR
Lane Configurations												
Traffic Volume (veh/h)	30	120	282	30	241	30	294	154	10	30	666	60
Future Volume (veh/h)	30	120	282	30	241	30	294	154	10	30	666	60
Initial Q (Qb), veh	0	0	0	0	0	0	0	0	0	0	0	0
Ped-Bike Adj(A_pbT)	1.00		0.99	1.00		0.99	1.00		1.00	1.00		0.99
Parking Bus, Adj	1.00	1.00	1.00	1.00	1.00	1.00	1.00	1.00	1.00	1.00	1.00	1.00
Work Zone On Approach		No			No			No			No	
Adj Sat Flow, veh/h/ln	1870	1870	1870	1870	1870	1870	1870	1870	1870	1870	1870	1870
Adj Flow Rate, veh/h	33	130	57	33	262	28	320	167	6	33	724	24
Peak Hour Factor	0.92	0.92	0.92	0.92	0.92	0.92	0.92	0.92	0.92	0.92	0.92	0.92
Percent Heavy Veh, %	2	2	2	2	2	2	2	2	2	2	2	2
Cap, veh/h	45	369	309	45	312	33	354	971	819	45	647	544
Arrive On Green	0.03	0.20	0.20	0.03	0.19	0.19	0.20	0.52	0.52	0.03	0.35	0.35
Sat Flow, veh/h	1781	1870	1565	1781	1659	177	1781	1870	1577	1781	1870	1574
Grp Volume(v), veh/h	33	130	57	33	0	290	320	167	6	33	724	24
Grp Sat Flow(s),veh/h/ln	1781	1870	1565	1781	0	1837	1781	1870	1577	1781	1870	1574
Q Serve(g_s), s	1.6	5.2	2.6	1.6	0.0	13.2	15.2	4.1	0.2	1.6	30.0	0.9
Cycle Q Clear(g_c), s	1.6	5.2	2.6	1.6	0.0	13.2	15.2	4.1	0.2	1.6	30.0	0.9
Prop In Lane	1.00		1.00	1.00		0.10	1.00		1.00	1.00		1.00
Lane Grp Cap(c), veh/h	45	369	309	45	0	345	354	971	819	45	647	544
V/C Ratio(X)	0.73	0.35	0.18	0.73	0.00	0.84	0.90	0.17	0.01	0.73	1.12	0.04
Avail Cap(c_a), veh/h	246	862	721	246	0	550	410	971	819	205	647	544
HCM Platoon Ratio	1.00	1.00	1.00	1.00	1.00	1.00	1.00	1.00	1.00	1.00	1.00	1.00
Upstream Filter(I)	1.00	1.00	1.00	1.00	0.00	1.00	1.00	1.00	1.00	1.00	1.00	1.00
Uniform Delay (d), s/veh	42.0	30.0	29.0	42.0	0.0	34.0	33.9	11.0	10.1	42.0	28.4	18.9
Incr Delay (d2), s/veh	8.2	0.2	0.1	8.2	0.0	3.4	19.4	0.0	0.0	8.2	73.1	0.0
Initial Q Delay(d3),s/veh	0.0	0.0	0.0	0.0	0.0	0.0	0.0	0.0	0.0	0.0	0.0	0.0
%ile BackOfQ(50%),veh/ln	0.8	2.3	1.0	0.8	0.0	6.1	8.2	1.6	0.1	0.8	25.6	0.3
Unsig. Movement Delay, s/veh												
LnGrp Delay(d),s/veh	50.2	30.3	29.1	50.2	0.0	37.3	53.4	11.0	10.1	50.2	101.5	18.9
LnGrp LOS	D	C	C	D	A	D	D	B	B	D	F	B
Approach Vol, veh/h		220			323			493			781	
Approach Delay, s/veh		33.0			38.7			38.5			96.8	
Approach LOS		C			D			D			F	
Timer - Assigned Phs	1	2	3	4	5	6	7	8				
Phs Duration (G+Y+Rc), s	6.8	22.5	22.4	35.1	7.6	21.7	7.3	50.2				
Change Period (Y+Rc), s	4.6	5.4	5.1	5.1	5.4	* 5.4	5.1	5.1				
Max Green Setting (Gmax)	12.0	40.0	20.0	30.0	12.0	* 26	10.0	30.0				
Max Q Clear Time (g_c+1)	13.6	7.2	17.2	32.0	3.6	15.2	3.6	6.1				
Green Ext Time (p_c), s	0.0	0.2	0.1	0.0	0.0	0.5	0.0	0.3				

Intersection Summary

HCM 6th Ctrl Delay	62.9
HCM 6th LOS	E

Notes

- User approved pedestrian interval to be less than phase max green.
- \* HCM 6th computational engine requires equal clearance times for the phases crossing the barrier.

Intersection												
Int Delay, s/veh	46.8											
Movement	EBL	EBT	EBR	WBL	WBT	WBR	NBL	NBT	NBR	SBL	SBT	SBR
Lane Configurations		↕			↕		↕	↑	↑	↑		↕
Traffic Vol, veh/h	40	10	20	142	10	10	10	347	80	20	858	20
Future Vol, veh/h	40	10	20	142	10	10	10	347	80	20	858	20
Conflicting Peds, #/hr	0	0	0	0	0	0	0	0	0	0	0	0
Sign Control	Stop	Stop	Stop	Stop	Stop	Stop	Free	Free	Free	Free	Free	Free
RT Channelized	-	-	None	-	-	None	-	-	None	-	-	None
Storage Length	-	-	-	-	-	-	50	-	270	-	-	-
Veh in Median Storage, #	-	0	-	-	0	-	-	0	-	-	0	-
Grade, %	-	0	-	-	0	-	-	0	-	-	0	-
Peak Hour Factor	92	92	92	92	92	92	92	92	92	92	92	92
Heavy Vehicles, %	2	2	2	2	2	2	2	2	2	2	2	2
Mvmt Flow	43	11	22	154	11	11	11	377	87	22	933	22

Major/Minor	Minor2		Minor1		Major1			Major2				
Conflicting Flow All	1442	1474	944	1404	1398	377	955	0	0	464	0	0
Stage 1	988	988	-	399	399	-	-	-	-	-	-	-
Stage 2	454	486	-	1005	999	-	-	-	-	-	-	-
Critical Hdwy	7.12	6.52	6.22	7.12	6.52	6.22	4.12	-	-	4.12	-	-
Critical Hdwy Stg 1	6.12	5.52	-	6.12	5.52	-	-	-	-	-	-	-
Critical Hdwy Stg 2	6.12	5.52	-	6.12	5.52	-	-	-	-	-	-	-
Follow-up Hdwy	3.518	4.018	3.318	3.518	4.018	3.318	2.218	-	-	2.218	-	-
Pot Cap-1 Maneuver	110	127	318	~117	141	670	720	-	-	1097	-	-
Stage 1	297	325	-	627	602	-	-	-	-	-	-	-
Stage 2	586	551	-	291	321	-	-	-	-	-	-	-
Platoon blocked, %								-	-	-	-	-
Mov Cap-1 Maneuver	97	120	318	~97	133	670	720	-	-	1097	-	-
Mov Cap-2 Maneuver	97	120	-	~97	133	-	-	-	-	-	-	-
Stage 1	293	311	-	618	593	-	-	-	-	-	-	-
Stage 2	557	543	-	250	307	-	-	-	-	-	-	-

Approach	EB	WB	NB	SB
HCM Control Delay, s	70.8	\$ 420.7	0.2	0.2
HCM LOS	F	F		

Minor Lane/Major Mvmt	NBL	NBT	NBR	EBLn1WBLn1	SBL	SBT	SBR
Capacity (veh/h)	720	-	-	125 104	1097	-	-
HCM Lane V/C Ratio	0.015	-	-	0.609 1.693	0.02	-	-
HCM Control Delay (s)	10.1	-	-	70.8\$ 420.7	8.3	0	-
HCM Lane LOS	B	-	-	F F	A A	-	-
HCM 95th %tile Q(veh)	0	-	-	3.1 13.8	0.1	-	-






















Notes  
 ~: Volume exceeds capacity    \$: Delay exceeds 300s    +: Computation Not Defined    \*: All major volume in platoon



# HCM 6th Signalized Intersection Summary

## 8: Old Redwood Hwy & Mark West Commons Cir/Wikiup Dr

Existing plus Project Conditions AM

												
Movement	EBL	EBT	EBR	WBL	WBT	WBR	NBL	NBT	NBR	SBL	SBT	SBR
Lane Configurations												
Traffic Volume (veh/h)	20	10	20	179	10	47	10	351	124	154	796	10
Future Volume (veh/h)	20	10	20	179	10	47	10	351	124	154	796	10
Initial Q (Qb), veh	0	0	0	0	0	0	0	0	0	0	0	0
Ped-Bike Adj(A_pbT)	0.99		0.99	0.99		0.99	1.00		0.99	1.00		1.00
Parking Bus, Adj	1.00	1.00	1.00	1.00	1.00	1.00	1.00	1.00	1.00	1.00	1.00	1.00
Work Zone On Approach		No			No			No			No	
Adj Sat Flow, veh/h/ln	1870	1870	1870	1870	1870	1870	1870	1870	1870	1870	1870	1870
Adj Flow Rate, veh/h	22	11	5	195	11	12	11	382	53	167	865	6
Peak Hour Factor	0.92	0.92	0.92	0.92	0.92	0.92	0.92	0.92	0.92	0.92	0.92	0.92
Percent Heavy Veh, %	2	2	2	2	2	2	2	2	2	2	2	2
Cap, veh/h	155	67	17	388	14	323	20	734	618	212	935	789
Arrive On Green	0.21	0.21	0.21	0.21	0.21	0.21	0.01	0.39	0.39	0.12	0.50	0.50
Sat Flow, veh/h	225	323	83	1233	70	1566	1781	1870	1575	1781	1870	1577
Grp Volume(v), veh/h	38	0	0	206	0	12	11	382	53	167	865	6
Grp Sat Flow(s),veh/h/ln	632	0	0	1303	0	1566	1781	1870	1575	1781	1870	1577
Q Serve(g_s), s	0.2	0.0	0.0	0.0	0.0	0.3	0.3	8.2	1.1	4.8	22.6	0.1
Cycle Q Clear(g_c), s	8.2	0.0	0.0	8.1	0.0	0.3	0.3	8.2	1.1	4.8	22.6	0.1
Prop In Lane	0.58		0.13	0.95		1.00	1.00		1.00	1.00		1.00
Lane Grp Cap(c), veh/h	239	0	0	403	0	323	20	734	618	212	935	789
V/C Ratio(X)	0.16	0.00	0.00	0.51	0.00	0.04	0.55	0.52	0.09	0.79	0.92	0.01
Avail Cap(c_a), veh/h	272	0	0	782	0	746	407	1069	901	407	1069	902
HCM Platoon Ratio	1.00	1.00	1.00	1.00	1.00	1.00	1.00	1.00	1.00	1.00	1.00	1.00
Upstream Filter(I)	1.00	0.00	0.00	1.00	0.00	1.00	1.00	1.00	1.00	1.00	1.00	1.00
Uniform Delay (d), s/veh	17.3	0.0	0.0	19.7	0.0	16.6	25.8	12.2	10.0	22.5	12.2	6.6
Incr Delay (d2), s/veh	0.1	0.0	0.0	0.4	0.0	0.0	8.3	0.2	0.0	2.5	11.5	0.0
Initial Q Delay(d3),s/veh	0.0	0.0	0.0	0.0	0.0	0.0	0.0	0.0	0.0	0.0	0.0	0.0
%ile BackOfQ(50%),veh/ln	0.4	0.0	0.0	2.2	0.0	0.1	0.2	2.8	0.3	1.9	9.7	0.0
Unsig. Movement Delay, s/veh												
LnGrp Delay(d),s/veh	17.4	0.0	0.0	20.1	0.0	16.7	34.1	12.4	10.0	24.9	23.7	6.6
LnGrp LOS	B	A	A	C	A	B	C	B	B	C	C	A
Approach Vol, veh/h		38			218			446			1038	
Approach Delay, s/veh		17.4			19.9			12.6			23.8	
Approach LOS		B			B			B			C	
Timer - Assigned Phs		2	3	4		6	7	8				
Phs Duration (G+Y+Rc), s		15.4	5.7	31.3		15.4	11.3	25.7				
Change Period (Y+Rc), s		4.6	5.1	5.1		4.6	5.1	5.1				
Max Green Setting (Gmax), s		12.0	12.0	30.0		25.0	12.0	30.0				
Max Q Clear Time (g_c+I1), s		10.2	2.3	24.6		10.1	6.8	10.2				
Green Ext Time (p_c), s		0.0	0.0	1.7		0.7	0.1	1.1				
<b>Intersection Summary</b>												
HCM 6th Ctrl Delay				20.3								
HCM 6th LOS				C								
<b>Notes</b>												
User approved pedestrian interval to be less than phase max green.												

Intersection						
Int Delay, s/veh	15					
Movement	EBL	EBT	WBT	WBR	SBL	SBR
Lane Configurations		↕	↑	↗	↖	↗
Traffic Vol, veh/h	65	255	145	156	342	23
Future Vol, veh/h	65	255	145	156	342	23
Conflicting Peds, #/hr	0	0	0	0	0	0
Sign Control	Free	Free	Free	Free	Stop	Stop
RT Channelized	-	None	-	Yield	-	None
Storage Length	-	-	-	150	90	0
Veh in Median Storage, #	-	0	0	-	0	-
Grade, %	-	0	0	-	0	-
Peak Hour Factor	92	92	92	92	92	92
Heavy Vehicles, %	2	2	2	2	2	2
Mvmt Flow	71	277	158	170	372	25




















Major/Minor	Major1	Major2	Minor2		
Conflicting Flow All	158	0	-	0	577 158
Stage 1	-	-	-	-	158 -
Stage 2	-	-	-	-	419 -
Critical Hdwy	4.12	-	-	-	6.42 6.22
Critical Hdwy Stg 1	-	-	-	-	5.42 -
Critical Hdwy Stg 2	-	-	-	-	5.42 -
Follow-up Hdwy	2.218	-	-	-	3.518 3.318
Pot Cap-1 Maneuver	1422	-	-	-	478 887
Stage 1	-	-	-	-	871 -
Stage 2	-	-	-	-	664 -
Platoon blocked, %		-	-	-	
Mov Cap-1 Maneuver	1422	-	-	-	450 887
Mov Cap-2 Maneuver	-	-	-	-	450 -
Stage 1	-	-	-	-	820 -
Stage 2	-	-	-	-	664 -

Approach	EB	WB	SB
HCM Control Delay, s	1.6	0	39
HCM LOS			E

Minor Lane/Major Mvmt	EBL	EBT	WBT	WBR	SBLn1	SBLn2
Capacity (veh/h)	1422	-	-	-	450	887
HCM Lane V/C Ratio	0.05	-	-	-	0.826	0.028
HCM Control Delay (s)	7.7	0	-	-	41	9.2
HCM Lane LOS	A	A	-	-	E	A
HCM 95th %tile Q(veh)	0.2	-	-	-	7.9	0.1

HCM 6th Signalized Intersection Summary  
 10: Gravenstein Hwy & Graton Rd/Frei Rd

Existing plus Project Conditions AM

												
Movement	EBL	EBT	EBR	WBL	WBT	WBR	NBL	NBT	NBR	SBL	SBT	SBR
Lane Configurations												
Traffic Volume (veh/h)	30	51	144	90	41	10	73	290	110	11	375	20
Future Volume (veh/h)	30	51	144	90	41	10	73	290	110	11	375	20
Initial Q (Qb), veh	0	0	0	0	0	0	0	0	0	0	0	0
Ped-Bike Adj(A_pbT)	0.99		0.99	0.99		0.99	1.00		0.99	1.00		0.99
Parking Bus, Adj	1.00	1.00	1.00	1.00	1.00	1.00	1.00	1.00	1.00	1.00	1.00	1.00
Work Zone On Approach		No			No			No			No	
Adj Sat Flow, veh/h/ln	1870	1870	1870	1870	1870	1870	1870	1870	1870	1870	1870	1870
Adj Flow Rate, veh/h	33	55	37	98	45	9	79	315	113	12	408	21
Peak Hour Factor	0.92	0.92	0.92	0.92	0.92	0.92	0.92	0.92	0.92	0.92	0.92	0.92
Percent Heavy Veh, %	2	2	2	2	2	2	2	2	2	2	2	2
Cap, veh/h	199	283	347	288	116	18	284	558	200	66	533	27
Arrive On Green	0.22	0.22	0.22	0.22	0.22	0.22	0.16	0.43	0.43	0.04	0.30	0.30
Sat Flow, veh/h	455	1279	1567	767	524	81	1781	1312	471	1781	1762	91
Grp Volume(v), veh/h	88	0	37	152	0	0	79	0	428	12	0	429
Grp Sat Flow(s),veh/h/ln	1734	0	1567	1372	0	0	1781	0	1782	1781	0	1853
Q Serve(g_s), s	0.0	0.0	0.9	3.3	0.0	0.0	2.0	0.0	9.1	0.3	0.0	10.5
Cycle Q Clear(g_c), s	1.9	0.0	0.9	5.2	0.0	0.0	2.0	0.0	9.1	0.3	0.0	10.5
Prop In Lane	0.37		1.00	0.64		0.06	1.00		0.26	1.00		0.05
Lane Grp Cap(c), veh/h	482	0	347	422	0	0	284	0	758	66	0	560
V/C Ratio(X)	0.18	0.00	0.11	0.36	0.00	0.00	0.28	0.00	0.57	0.18	0.00	0.77
Avail Cap(c_a), veh/h	1744	0	1561	562	0	0	568	0	1776	1775	0	923
HCM Platoon Ratio	1.00	1.00	1.00	1.00	1.00	1.00	1.00	1.00	1.00	1.00	1.00	1.00
Upstream Filter(I)	1.00	0.00	1.00	1.00	0.00	0.00	1.00	0.00	1.00	1.00	0.00	1.00
Uniform Delay (d), s/veh	16.0	0.0	15.6	17.3	0.0	0.0	18.5	0.0	10.9	23.4	0.0	15.9
Incr Delay (d2), s/veh	0.2	0.0	0.1	0.5	0.0	0.0	0.5	0.0	0.7	1.3	0.0	2.2
Initial Q Delay(d3),s/veh	0.0	0.0	0.0	0.0	0.0	0.0	0.0	0.0	0.0	0.0	0.0	0.0
%ile BackOfQ(50%),veh/ln	0.7	0.0	0.3	1.4	0.0	0.0	0.7	0.0	2.6	0.1	0.0	3.8
Unsig. Movement Delay, s/veh												
LnGrp Delay(d),s/veh	16.1	0.0	15.7	17.8	0.0	0.0	19.1	0.0	11.6	24.8	0.0	18.1
LnGrp LOS	B	A	B	B	A	A	B	A	B	C	A	B
Approach Vol, veh/h		125			152			507				441
Approach Delay, s/veh		16.0			17.8			12.7				18.3
Approach LOS		B			B			B				B
Timer - Assigned Phs	1	2		4	5	6		8				
Phs Duration (G+Y+Rc), s	12.7	21.0		16.5	6.5	27.1		16.5				
Change Period (Y+Rc), s	* 4.7	5.8		5.4	* 4.7	5.8		5.4				
Max Green Setting (Gmax), s	* 16	25.0		16.0	* 50	50.0		50.0				
Max Q Clear Time (g_c+I1), s	4.0	12.5		7.2	2.3	11.1		3.9				
Green Ext Time (p_c), s	0.1	1.9		0.4	0.0	2.7		0.6				
<b>Intersection Summary</b>												
HCM 6th Ctrl Delay			15.7									
HCM 6th LOS			B									
<b>Notes</b>												
User approved pedestrian interval to be less than phase max green.												
* HCM 6th computational engine requires equal clearance times for the phases crossing the barrier.												

HCM 6th TWSC  
 11: Private Dwy/Moorland Ave & Todd Rd

Existing plus Project Conditions AM

Intersection												
Int Delay, s/veh	185.9											
Movement	EBL	EBT	EBR	WBL	WBT	WBR	NBL	NBT	NBR	SBL	SBT	SBR
Lane Configurations	↖	↗		↖	↗			↕			↖	↗
Traffic Vol, veh/h	52	459	10	10	435	329	10	10	10	315	10	72
Future Vol, veh/h	52	459	10	10	435	329	10	10	10	315	10	72
Conflicting Peds, #/hr	0	0	0	0	0	0	0	0	0	0	0	0
Sign Control	Free	Free	Free	Free	Free	Free	Stop	Stop	Stop	Stop	Stop	Stop
RT Channelized	-	-	None	-	-	None	-	-	None	-	-	None
Storage Length	100	-	-	70	-	-	-	-	-	-	-	60
Veh in Median Storage, #	-	0	-	-	0	-	-	0	-	-	0	-
Grade, %	-	0	-	-	0	-	-	0	-	-	0	-
Peak Hour Factor	92	92	92	92	92	92	92	92	92	92	92	92
Heavy Vehicles, %	2	2	2	2	2	2	2	2	2	2	2	2
Mvmt Flow	57	499	11	11	473	358	11	11	11	342	11	78

Major/Minor	Major1			Major2			Minor1			Minor2		
Conflicting Flow All	831	0	0	510	0	0	1338	1472	505	1304	1298	652
Stage 1	-	-	-	-	-	-	619	619	-	674	674	-
Stage 2	-	-	-	-	-	-	719	853	-	630	624	-
Critical Hdwy	4.12	-	-	4.12	-	-	7.12	6.52	6.22	7.12	6.52	6.22
Critical Hdwy Stg 1	-	-	-	-	-	-	6.12	5.52	-	6.12	5.52	-
Critical Hdwy Stg 2	-	-	-	-	-	-	6.12	5.52	-	6.12	5.52	-
Follow-up Hdwy	2.218	-	-	2.218	-	-	3.518	4.018	3.318	3.518	4.018	3.318
Pot Cap-1 Maneuver	801	-	-	1055	-	-	130	127	567	~ 137	162	468
Stage 1	-	-	-	-	-	-	476	480	-	444	454	-
Stage 2	-	-	-	-	-	-	420	376	-	470	478	-
Platoon blocked, %		-	-	-	-	-						
Mov Cap-1 Maneuver	801	-	-	1055	-	-	96	117	567	~ 117	149	468
Mov Cap-2 Maneuver	-	-	-	-	-	-	96	117	-	~ 117	149	-
Stage 1	-	-	-	-	-	-	442	446	-	412	449	-
Stage 2	-	-	-	-	-	-	338	372	-	418	444	-

Approach	EB			WB			NB			SB		
HCM Control Delay, s	1			0.1			36.9			\$ 801.9		
HCM LOS							E			F		





















Minor Lane/Major Mvmt	NBLn1	EBL	EBT	EBR	WBL	WBT	WBR	SBLn1	SBLn2
Capacity (veh/h)	145	801	-	-	1055	-	-	118	468
HCM Lane V/C Ratio	0.225	0.071	-	-	0.01	-	-	2.994	0.167
HCM Control Delay (s)	36.9	9.8	-	-	8.4	-	-	\$ 976.4	14.2
HCM Lane LOS	E	A	-	-	A	-	-	F	B
HCM 95th %tile Q(veh)	0.8	0.2	-	-	0	-	-	33.4	0.6

Notes  
 ~: Volume exceeds capacity    \$: Delay exceeds 300s    +: Computation Not Defined    \*: All major volume in platoon

# HCM 6th Signalized Intersection Summary

## 12: S Moreland Ave & Todd Rd

Existing plus Project Conditions AM

												
Movement	EBL	EBT	EBR	WBL	WBT	WBR	NBL	NBT	NBR	SBL	SBT	SBR
Lane Configurations												
Traffic Volume (veh/h)	0	430	354	350	247	0	527	0	177	0	0	0
Future Volume (veh/h)	0	430	354	350	247	0	527	0	177	0	0	0
Initial Q (Qb), veh	0	0	0	0	0	0	0	0	0	0	0	0
Ped-Bike Adj(A_pbT)	1.00		1.00	1.00		1.00	1.00		1.00	1.00		1.00
Parking Bus, Adj	1.00	1.00	1.00	1.00	1.00	1.00	1.00	1.00	1.00	1.00	1.00	1.00
Work Zone On Approach		No			No			No			No	
Adj Sat Flow, veh/h/ln	1870	1870	1870	1870	1870	1870	1870	1870	1870	1870	1870	1870
Adj Flow Rate, veh/h	0	467	210	380	268	0	573	0	128	0	0	0
Peak Hour Factor	0.92	0.92	0.92	0.92	0.92	0.92	0.92	0.92	0.92	0.92	0.92	0.92
Percent Heavy Veh, %	2	2	2	2	2	2	2	2	2	2	2	2
Cap, veh/h	0	509	431	463	486	0	608	0	1082	0	3	0
Arrive On Green	0.00	0.27	0.27	0.26	0.26	0.00	0.34	0.00	0.34	0.00	0.00	0.00
Sat Flow, veh/h	0	1870	1585	1781	1870	0	1781	0	3170	0	1870	0
Grp Volume(v), veh/h	0	467	210	380	268	0	573	0	128	0	0	0
Grp Sat Flow(s),veh/h/ln	0	1870	1585	1781	1870	0	1781	0	1585	0	1870	0
Q Serve(g_s), s	0.0	17.6	8.1	14.6	9.0	0.0	22.7	0.0	2.0	0.0	0.0	0.0
Cycle Q Clear(g_c), s	0.0	17.6	8.1	14.6	9.0	0.0	22.7	0.0	2.0	0.0	0.0	0.0
Prop In Lane	0.00		1.00	1.00		0.00	1.00		1.00	0.00		0.00
Lane Grp Cap(c), veh/h	0	509	431	463	486	0	608	0	1082	0	3	0
V/C Ratio(X)	0.00	0.92	0.49	0.82	0.55	0.00	0.94	0.00	0.12	0.00	0.00	0.00
Avail Cap(c_a), veh/h	0	515	436	735	772	0	613	0	1091	0	206	0
HCM Platoon Ratio	1.00	1.00	1.00	1.00	1.00	1.00	1.00	1.00	1.00	1.00	1.00	1.00
Upstream Filter(I)	0.00	1.00	1.00	1.00	1.00	0.00	1.00	0.00	1.00	0.00	0.00	0.00
Uniform Delay (d), s/veh	0.0	25.7	22.2	25.3	23.2	0.0	23.2	0.0	16.4	0.0	0.0	0.0
Incr Delay (d2), s/veh	0.0	21.4	0.9	4.1	1.0	0.0	23.0	0.0	0.0	0.0	0.0	0.0
Initial Q Delay(d3),s/veh	0.0	0.0	0.0	0.0	0.0	0.0	0.0	0.0	0.0	0.0	0.0	0.0
%ile BackOfQ(50%),veh/ln	0.0	10.2	2.9	6.2	3.8	0.0	12.7	0.0	0.7	0.0	0.0	0.0
Unsig. Movement Delay, s/veh												
LnGrp Delay(d),s/veh	0.0	47.1	23.0	29.4	24.2	0.0	46.3	0.0	16.5	0.0	0.0	0.0
LnGrp LOS	A	D	C	C	C	A	D	A	B	A	A	A
Approach Vol, veh/h		677			648			701				0
Approach Delay, s/veh		39.6			27.2			40.8				0.0
Approach LOS		D			C			D				
Timer - Assigned Phs		2		4		6		8				
Phs Duration (G+Y+Rc), s		0.0		23.0		27.8		21.9				
Change Period (Y+Rc), s		3.0		3.2		3.0		3.0				
Max Green Setting (Gmax), s		8.0		20.0		25.0		30.0				
Max Q Clear Time (g_c+I1), s		0.0		19.6		24.7		16.6				
Green Ext Time (p_c), s		0.0		0.2		0.1		2.3				

### Intersection Summary

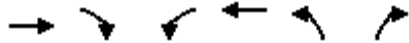
HCM 6th Ctrl Delay	36.1
HCM 6th LOS	D

### Notes

- User approved pedestrian interval to be less than phase max green.
- User approved volume balancing among the lanes for turning movement.

HCM 6th Signalized Intersection Summary  
 13: Todd Rd Overpass & Todd Rd

Existing plus Project Conditions AM



Movement	EBT	EBR	WBL	WBT	NBL	NBR
Lane Configurations	↑↑	↗	↖	↑↑	↖	↗
Traffic Volume (veh/h)	216	250	444	296	237	487
Future Volume (veh/h)	216	250	444	296	237	487
Initial Q (Qb), veh	0	0	0	0	0	0
Ped-Bike Adj(A_pbT)		1.00	1.00		1.00	1.00
Parking Bus, Adj	1.00	1.00	1.00	1.00	1.00	1.00
Work Zone On Approach	No			No	No	
Adj Sat Flow, veh/h/ln	1870	1870	1870	1870	1870	1870
Adj Flow Rate, veh/h	235	57	483	322	258	295
Peak Hour Factor	0.92	0.92	0.92	0.92	0.92	0.92
Percent Heavy Veh, %	2	2	2	2	2	2
Cap, veh/h	549	245	1026	539	413	1450
Arrive On Green	0.15	0.15	0.29	0.29	0.23	0.23
Sat Flow, veh/h	3647	1585	3563	1870	1781	2790
Grp Volume(v), veh/h	235	57	483	322	258	295
Grp Sat Flow(s),veh/h/ln1777		1585	1781	1870	1781	1395
Q Serve(g_s), s	1.9	1.0	3.6	4.8	4.2	1.8
Cycle Q Clear(g_c), s	1.9	1.0	3.6	4.8	4.2	1.8
Prop In Lane		1.00	1.00		1.00	1.00
Lane Grp Cap(c), veh/h	549	245	1026	539	413	1450
V/C Ratio(X)	0.43	0.23	0.47	0.60	0.63	0.20
Avail Cap(c_a), veh/h	2206	984	1659	871	774	2016
HCM Platoon Ratio	1.00	1.00	1.00	1.00	1.00	1.00
Upstream Filter(I)	1.00	1.00	1.00	1.00	1.00	1.00
Uniform Delay (d), s/veh	12.3	11.9	9.4	9.9	11.1	4.2
Incr Delay (d2), s/veh	0.5	0.5	0.3	1.1	1.6	0.1
Initial Q Delay(d3),s/veh	0.0	0.0	0.0	0.0	0.0	0.0
%ile BackOfQ(50%),veh/ln0.6		0.3	1.0	1.5	1.4	0.7
Unsig. Movement Delay, s/veh						
LnGrp Delay(d),s/veh	12.9	12.4	9.8	10.9	12.7	4.2
LnGrp LOS	B	B	A	B	B	A
Approach Vol, veh/h	292			805	553	
Approach Delay, s/veh	12.8			10.2	8.2	
Approach LOS	B			B	A	
Timer - Assigned Phs		2			6	8
Phs Duration (G+Y+Rc), s		8.5			12.8	11.0
Change Period (Y+Rc), s		3.5			3.5	3.5
Max Green Setting (Gmax), s		20.0			15.0	14.0
Max Q Clear Time (g_c+I1), s		3.9			6.8	6.2
Green Ext Time (p_c), s		1.4			2.5	1.3
<b>Intersection Summary</b>						
HCM 6th Ctrl Delay			10.0			
HCM 6th LOS			A			
<b>Notes</b>						
User approved volume balancing among the lanes for turning movement.						

# HCM 6th Signalized Intersection Summary

## 14: Santa Rosa Ave & Todd Rd

Existing plus Project Conditions AM



Movement	EBL	EBT	EBR	WBL	WBT	WBR	NBL	NBT	NBR	SBL	SBT	SBR
Lane Configurations												
Traffic Volume (veh/h)	330	100	273	20	30	30	369	671	40	50	335	341
Future Volume (veh/h)	330	100	273	20	30	30	369	671	40	50	335	341
Initial Q (Qb), veh	0	0	0	0	0	0	0	0	0	0	0	0
Ped-Bike Adj(A_pbT)	1.00		0.99	1.00		1.00	1.00		0.99	1.00		0.99
Parking Bus, Adj	1.00	1.00	1.00	1.00	1.00	1.00	1.00	1.00	1.00	1.00	1.00	1.00
Work Zone On Approach		No			No			No			No	
Adj Sat Flow, veh/h/ln	1870	1870	1870	1870	1870	1870	1870	1870	1870	1870	1870	1870
Adj Flow Rate, veh/h	234	284	61	22	33	1	401	729	18	54	364	80
Peak Hour Factor	0.92	0.92	0.92	0.92	0.92	0.92	0.92	0.92	0.92	0.92	0.92	0.92
Percent Heavy Veh, %	2	2	2	2	2	2	2	2	2	2	2	2
Cap, veh/h	349	367	308	73	74	2	451	1290	571	71	551	243
Arrive On Green	0.20	0.20	0.20	0.04	0.04	0.04	0.25	0.36	0.36	0.04	0.16	0.16
Sat Flow, veh/h	1781	1870	1573	1781	1806	55	1781	3554	1574	1781	3554	1570
Grp Volume(v), veh/h	234	284	61	22	0	34	401	729	18	54	364	80
Grp Sat Flow(s),veh/h/ln	1781	1870	1573	1781	0	1861	1781	1777	1574	1781	1777	1570
Q Serve(g_s), s	7.1	8.4	1.9	0.7	0.0	1.0	12.7	9.6	0.4	1.8	5.6	2.6
Cycle Q Clear(g_c), s	7.1	8.4	1.9	0.7	0.0	1.0	12.7	9.6	0.4	1.8	5.6	2.6
Prop In Lane	1.00		1.00	1.00		0.03	1.00		1.00	1.00		1.00
Lane Grp Cap(c), veh/h	349	367	308	73	0	76	451	1290	571	71	551	243
V/C Ratio(X)	0.67	0.77	0.20	0.30	0.00	0.45	0.89	0.57	0.03	0.76	0.66	0.33
Avail Cap(c_a), veh/h	550	577	485	305	0	319	519	1462	648	305	975	431
HCM Platoon Ratio	1.00	1.00	1.00	1.00	1.00	1.00	1.00	1.00	1.00	1.00	1.00	1.00
Upstream Filter(I)	1.00	1.00	1.00	1.00	0.00	1.00	1.00	1.00	1.00	1.00	1.00	1.00
Uniform Delay (d), s/veh	21.7	22.2	19.6	27.2	0.0	27.3	21.0	14.9	12.0	27.7	23.2	21.9
Incr Delay (d2), s/veh	0.8	1.3	0.1	0.9	0.0	1.5	14.5	0.1	0.0	6.0	0.5	0.3
Initial Q Delay(d3),s/veh	0.0	0.0	0.0	0.0	0.0	0.0	0.0	0.0	0.0	0.0	0.0	0.0
%ile BackOfQ(50%),veh/ln	2.8	3.5	0.6	0.3	0.0	0.5	6.5	3.3	0.1	0.8	2.1	0.9
Unsig. Movement Delay, s/veh												
LnGrp Delay(d),s/veh	22.5	23.6	19.7	28.0	0.0	28.8	35.5	15.0	12.0	33.7	23.7	22.2
LnGrp LOS	C	C	B	C	A	C	D	B	B	C	C	C
Approach Vol, veh/h		579			56			1148			498	
Approach Delay, s/veh		22.7			28.5			22.1			24.5	
Approach LOS		C			C			C			C	
Timer - Assigned Phs		2	3	4		6	7	8				
Phs Duration (G+Y+Rc), s		16.5	19.9	14.4		7.5	7.7	26.6				
Change Period (Y+Rc), s		5.1	5.1	5.4		5.1	5.4	* 5.4				
Max Green Setting (Gmax), s		18.0	17.0	16.0		10.0	10.0	* 24				
Max Q Clear Time (g_c+I1), s		10.4	14.7	7.6		3.0	3.8	11.6				
Green Ext Time (p_c), s		0.8	0.1	0.8		0.0	0.0	2.2				

### Intersection Summary

HCM 6th Ctrl Delay	23.0
HCM 6th LOS	C

### Notes

- User approved pedestrian interval to be less than phase max green.
- User approved volume balancing among the lanes for turning movement.
- \* HCM 6th computational engine requires equal clearance times for the phases crossing the barrier.

<b>Intersection</b>												
Intersection Delay, s/veh	11.4											
Intersection LOS	B											

Movement	EBL	EBT	EBR	WBL	WBT	WBR	NBL	NBT	NBR	SBL	SBT	SBR
Lane Configurations		↕			↕			↕			↕	
Traffic Vol, veh/h	40	10	241	10	10	10	122	112	10	10	191	40
Future Vol, veh/h	40	10	241	10	10	10	122	112	10	10	191	40
Peak Hour Factor	0.92	0.92	0.92	0.92	0.92	0.92	0.92	0.92	0.92	0.92	0.92	0.92
Heavy Vehicles, %	2	2	2	2	2	2	2	2	2	2	2	2
Mvmt Flow	43	11	262	11	11	11	133	122	11	11	208	43
Number of Lanes	0	1	0	0	1	0	0	1	0	0	1	0

Approach	EB	WB	NB	SB
Opposing Approach	WB	EB	SB	NB
Opposing Lanes	1	1	1	1
Conflicting Approach Left	SB	NB	EB	WB
Conflicting Lanes Left	1	1	1	1
Conflicting Approach Right	NB	SB	WB	EB
Conflicting Lanes Right	1	1	1	1
HCM Control Delay	11.6	9.1	11.7	11.3
HCM LOS	B	A	B	B

Lane	NBLn1	EBLn1	WBLn1	SBLn1
Vol Left, %	50%	14%	33%	4%
Vol Thru, %	46%	3%	33%	79%
Vol Right, %	4%	83%	33%	17%
Sign Control	Stop	Stop	Stop	Stop
Traffic Vol by Lane	244	291	30	241
LT Vol	122	40	10	10
Through Vol	112	10	10	191
RT Vol	10	241	10	40
Lane Flow Rate	265	316	33	262
Geometry Grp	1	1	1	1
Degree of Util (X)	0.391	0.433	0.052	0.375
Departure Headway (Hd)	5.31	4.927	5.718	5.158
Convergence, Y/N	Yes	Yes	Yes	Yes
Cap	676	737	625	697
Service Time	3.346	2.927	3.765	3.194
HCM Lane V/C Ratio	0.392	0.429	0.053	0.376
HCM Control Delay	11.7	11.6	9.1	11.3
HCM Lane LOS	B	B	A	B
HCM 95th-tile Q	1.9	2.2	0.2	1.7



HCM 6th TWSC  
16: Riverside Dr & Verano Ave

Existing plus Project Conditions AM

Intersection												
Int Delay, s/veh	15.3											
Movement	EBL	EBT	EBR	WBL	WBT	WBR	NBL	NBT	NBR	SBL	SBT	SBR
Lane Configurations												
Traffic Vol, veh/h	42	270	10	90	260	52	20	20	20	127	20	47
Future Vol, veh/h	42	270	10	90	260	52	20	20	20	127	20	47
Conflicting Peds, #/hr	0	0	0	0	0	0	0	0	0	0	0	0
Sign Control	Free	Free	Free	Free	Free	Free	Stop	Stop	Stop	Stop	Stop	Stop
RT Channelized	-	-	None	-	-	None	-	-	None	-	-	None
Storage Length	100	-	-	-	-	-	-	-	-	-	-	-
Veh in Median Storage, #	-	0	-	-	0	-	-	0	-	-	0	-
Grade, %	-	0	-	-	0	-	-	0	-	-	0	-
Peak Hour Factor	92	92	92	92	92	92	92	92	92	92	92	92
Heavy Vehicles, %	2	2	2	2	2	2	2	2	2	2	2	2
Mvmt Flow	46	293	11	98	283	57	22	22	22	138	22	51

Major/Minor	Major1			Major2			Minor1			Minor2		
Conflicting Flow All	340	0	0	304	0	0	935	927	299	921	904	312
Stage 1	-	-	-	-	-	-	391	391	-	508	508	-
Stage 2	-	-	-	-	-	-	544	536	-	413	396	-
Critical Hdwy	4.12	-	-	4.12	-	-	7.12	6.52	6.22	7.12	6.52	6.22
Critical Hdwy Stg 1	-	-	-	-	-	-	6.12	5.52	-	6.12	5.52	-
Critical Hdwy Stg 2	-	-	-	-	-	-	6.12	5.52	-	6.12	5.52	-
Follow-up Hdwy	2.218	-	-	2.218	-	-	3.518	4.018	3.318	3.518	4.018	3.318
Pot Cap-1 Maneuver	1219	-	-	1257	-	-	246	268	741	251	277	728
Stage 1	-	-	-	-	-	-	633	607	-	547	539	-
Stage 2	-	-	-	-	-	-	523	523	-	616	604	-
Platoon blocked, %	-	-	-	-	-	-	-	-	-	-	-	-
Mov Cap-1 Maneuver	1219	-	-	1257	-	-	192	233	741	204	241	728
Mov Cap-2 Maneuver	-	-	-	-	-	-	192	233	-	204	241	-
Stage 1	-	-	-	-	-	-	609	584	-	526	487	-
Stage 2	-	-	-	-	-	-	420	472	-	554	581	-

Approach	EB			WB			NB			SB		
HCM Control Delay, s	1.1			1.8			22			64.6		
HCM LOS							C			F		

Minor Lane/Major Mvmt	NBLn1	EBL	EBT	EBR	WBL	WBT	WBR	SBLn1
Capacity (veh/h)	277	1219	-	-	1257	-	-	252
HCM Lane V/C Ratio	0.235	0.037	-	-	0.078	-	-	0.837
HCM Control Delay (s)	22	8.1	-	-	8.1	0	-	64.6
HCM Lane LOS	C	A	-	-	A	A	-	F
HCM 95th %tile Q(veh)	0.9	0.1	-	-	0.3	-	-	6.7

HCM 6th Signalized Intersection Summary  
 17: Main St/Petaluma Hill Rd & Old Adobe Rd/Adobe Rd

Existing plus Project Conditions AM



Movement	EBL	EBT	EBR	WBL	WBT	WBR	NBL	NBT	NBR	SBL	SBT	SBR
Lane Configurations		↔			↔			↔		↔	↔	↔
Traffic Volume (veh/h)	44	194	70	10	92	300	40	203	10	370	494	51
Future Volume (veh/h)	44	194	70	10	92	300	40	203	10	370	494	51
Initial Q (Qb), veh	0	0	0	0	0	0	0	0	0	0	0	0
Ped-Bike Adj(A_pbT)	0.99		0.99	1.00		0.99	1.00		1.00	1.00		0.99
Parking Bus, Adj	1.00	1.00	1.00	1.00	1.00	1.00	1.00	1.00	1.00	1.00	1.00	1.00
Work Zone On Approach		No			No			No			No	
Adj Sat Flow, veh/h/ln	1870	1870	1870	1870	1870	1870	1870	1870	1870	1870	1870	1870
Adj Flow Rate, veh/h	48	211	60	11	100	162	43	221	9	402	537	51
Peak Hour Factor	0.92	0.92	0.92	0.92	0.92	0.92	0.92	0.92	0.92	0.92	0.92	0.92
Percent Heavy Veh, %	2	2	2	2	2	2	2	2	2	2	2	2
Cap, veh/h	122	293	77	80	153	233	56	289	12	481	454	43
Arrive On Green	0.23	0.23	0.23	0.23	0.23	0.23	0.19	0.19	0.19	0.27	0.27	0.27
Sat Flow, veh/h	172	1257	331	28	658	1001	291	1493	61	1781	1680	160
Grp Volume(v), veh/h	319	0	0	273	0	0	273	0	0	402	0	588
Grp Sat Flow(s),veh/h/ln	1760	0	0	1686	0	0	1845	0	0	1781	0	1840
Q Serve(g_s), s	0.8	0.0	0.0	0.0	0.0	0.0	7.1	0.0	0.0	10.8	0.0	13.7
Cycle Q Clear(g_c), s	8.3	0.0	0.0	7.5	0.0	0.0	7.1	0.0	0.0	10.8	0.0	13.7
Prop In Lane	0.15		0.19	0.04		0.59	0.16		0.03	1.00		0.09
Lane Grp Cap(c), veh/h	492	0	0	467	0	0	357	0	0	481	0	497
V/C Ratio(X)	0.65	0.00	0.00	0.58	0.00	0.00	0.76	0.00	0.00	0.84	0.00	1.18
Avail Cap(c_a), veh/h	886	0	0	1011	0	0	691	0	0	481	0	497
HCM Platoon Ratio	1.00	1.00	1.00	1.00	1.00	1.00	1.00	1.00	1.00	1.00	1.00	1.00
Upstream Filter(I)	1.00	0.00	0.00	1.00	0.00	0.00	1.00	0.00	0.00	1.00	0.00	1.00
Uniform Delay (d), s/veh	18.1	0.0	0.0	17.8	0.0	0.0	19.4	0.0	0.0	17.5	0.0	18.5
Incr Delay (d2), s/veh	0.5	0.0	0.0	0.4	0.0	0.0	2.6	0.0	0.0	11.5	0.0	101.8
Initial Q Delay(d3),s/veh	0.0	0.0	0.0	0.0	0.0	0.0	0.0	0.0	0.0	0.0	0.0	0.0
%ile BackOfQ(50%),veh/ln	3.1	0.0	0.0	2.5	0.0	0.0	3.0	0.0	0.0	5.3	0.0	18.9
Unsig. Movement Delay, s/veh												
LnGrp Delay(d),s/veh	18.7	0.0	0.0	18.3	0.0	0.0	21.9	0.0	0.0	29.0	0.0	120.3
LnGrp LOS	B	A	A	B	A	A	C	A	A	C	A	F
Approach Vol, veh/h		319			273			273				990
Approach Delay, s/veh		18.7			18.3			21.9				83.2
Approach LOS		B			B			C				F
Timer - Assigned Phs		2		4		6		8				
Phs Duration (G+Y+Rc), s		14.4		17.2		19.1		17.2				
Change Period (Y+Rc), s		4.6		* 5.4		5.4		5.4				
Max Green Setting (Gmax), s		19.0		* 24		13.7		28.7				
Max Q Clear Time (g_c+I1), s		9.1		10.3		15.7		9.5				
Green Ext Time (p_c), s		0.9		0.6		0.0		0.5				

Intersection Summary

HCM 6th Ctrl Delay	53.5
HCM 6th LOS	D

Notes

- User approved pedestrian interval to be less than phase max green.
- \* HCM 6th computational engine requires equal clearance times for the phases crossing the barrier.

HCM 6th Signalized Intersection Summary  
 18: Old Redwood Hwy & Main St

Existing plus Project Conditions AM



Movement	WBL	WBR	NBT	NBR	SBL	SBT
Lane Configurations						
Traffic Volume (veh/h)	520	23	208	255	33	546
Future Volume (veh/h)	520	23	208	255	33	546
Initial Q (Qb), veh	0	0	0	0	0	0
Ped-Bike Adj(A_pbT)	1.00	1.00		1.00	1.00	
Parking Bus, Adj	1.00	1.00	1.00	1.00	1.00	1.00
Work Zone On Approach	No		No		No	
Adj Sat Flow, veh/h/ln	1870	1870	1870	1870	1870	1870
Adj Flow Rate, veh/h	565	10	226	277	36	593
Peak Hour Factor	0.92	0.92	0.92	0.92	0.92	0.92
Percent Heavy Veh, %	2	2	2	2	2	2
Cap, veh/h	628	559	416	352	58	744
Arrive On Green	0.35	0.35	0.22	0.22	0.03	0.40
Sat Flow, veh/h	1781	1585	1870	1585	1781	1870
Grp Volume(v), veh/h	565	10	226	277	36	593
Grp Sat Flow(s),veh/h/ln	1781	1585	1870	1585	1781	1870
Q Serve(g_s), s	13.0	0.2	4.6	7.1	0.9	12.1
Cycle Q Clear(g_c), s	13.0	0.2	4.6	7.1	0.9	12.1
Prop In Lane	1.00	1.00		1.00	1.00	
Lane Grp Cap(c), veh/h	628	559	416	352	58	744
V/C Ratio(X)	0.90	0.02	0.54	0.79	0.62	0.80
Avail Cap(c_a), veh/h	1234	1098	1296	1098	494	1296
HCM Platoon Ratio	1.00	1.00	1.00	1.00	1.00	1.00
Upstream Filter(I)	1.00	1.00	1.00	1.00	1.00	1.00
Uniform Delay (d), s/veh	13.3	9.1	14.9	15.9	20.7	11.5
Incr Delay (d2), s/veh	2.0	0.0	0.4	1.5	4.0	0.8
Initial Q Delay(d3),s/veh	0.0	0.0	0.0	0.0	0.0	0.0
%ile BackOfQ(50%),veh/ln	4.6	0.1	1.6	2.2	0.4	3.5
Unsig. Movement Delay, s/veh						
LnGrp Delay(d),s/veh	15.2	9.1	15.3	17.4	24.7	12.2
LnGrp LOS	B	A	B	B	C	B
Approach Vol, veh/h	575		503			629
Approach Delay, s/veh	15.1		16.4			13.0
Approach LOS	B		B			B
Timer - Assigned Phs	1	2		4		6
Phs Duration (G+Y+Rc), s	7.6	15.8		19.9		23.4
Change Period (Y+Rc), s	6.2	6.2		4.6		6.2
Max Green Setting (Gmax)	30.0	30.0		30.0		30.0
Max Q Clear Time (g_c+1)	9.1	9.1		15.0		14.1
Green Ext Time (p_c), s	0.0	0.5		0.3		1.1

Intersection Summary

HCM 6th Ctrl Delay	14.7
HCM 6th LOS	B

Notes

User approved pedestrian interval to be less than phase max green.

HCM 6th TWSC  
 19: Private Dwy/Paula Ln & Bodega Ave

Existing plus Project Conditions AM

Intersection												
Int Delay, s/veh	2.8											
Movement	EBL	EBT	EBR	WBL	WBT	WBR	NBL	NBT	NBR	SBL	SBT	SBR
Lane Configurations	↖	↗		↖	↗			↕			↕	
Traffic Vol, veh/h	20	505	5	15	375	25	5	10	25	45	5	20
Future Vol, veh/h	20	505	5	15	375	25	5	10	25	45	5	20
Conflicting Peds, #/hr	0	0	0	0	0	0	0	0	0	0	0	0
Sign Control	Free	Free	Free	Free	Free	Free	Stop	Stop	Stop	Stop	Stop	Stop
RT Channelized	-	-	None	-	-	None	-	-	None	-	-	None
Storage Length	90	-	-	90	-	-	-	-	-	-	-	-
Veh in Median Storage, #	-	0	-	-	0	-	-	0	-	-	0	-
Grade, %	-	0	-	-	0	-	-	0	-	-	0	-
Peak Hour Factor	92	92	92	92	92	92	92	92	92	92	92	92
Heavy Vehicles, %	2	2	2	2	2	2	2	2	2	2	2	2
Mvmt Flow	22	549	5	16	408	27	5	11	27	49	5	22

Major/Minor	Major1			Major2			Minor1			Minor2		
Conflicting Flow All	435	0	0	554	0	0	1063	1063	552	1069	1052	422
Stage 1	-	-	-	-	-	-	596	596	-	454	454	-
Stage 2	-	-	-	-	-	-	467	467	-	615	598	-
Critical Hdwy	4.12	-	-	4.12	-	-	7.12	6.52	6.22	7.12	6.52	6.22
Critical Hdwy Stg 1	-	-	-	-	-	-	6.12	5.52	-	6.12	5.52	-
Critical Hdwy Stg 2	-	-	-	-	-	-	6.12	5.52	-	6.12	5.52	-
Follow-up Hdwy	2.218	-	-	2.218	-	-	3.518	4.018	3.318	3.518	4.018	3.318
Pot Cap-1 Maneuver	1125	-	-	1016	-	-	201	223	533	199	227	632
Stage 1	-	-	-	-	-	-	490	492	-	586	569	-
Stage 2	-	-	-	-	-	-	576	562	-	479	491	-
Platoon blocked, %		-	-		-	-						
Mov Cap-1 Maneuver	1125	-	-	1016	-	-	185	215	533	177	219	632
Mov Cap-2 Maneuver	-	-	-	-	-	-	185	215	-	177	219	-
Stage 1	-	-	-	-	-	-	480	482	-	574	560	-
Stage 2	-	-	-	-	-	-	542	553	-	436	481	-

Approach	EB			WB			NB			SB		
HCM Control Delay, s	0.3			0.3			17.5			28.7		
HCM LOS							C			D		

Minor Lane/Major Mvmt	NBLn1	EBL	EBT	EBR	WBL	WBT	WBR	SBLn1
Capacity (veh/h)	332	1125	-	-	1016	-	-	227
HCM Lane V/C Ratio	0.131	0.019	-	-	0.016	-	-	0.335
HCM Control Delay (s)	17.5	8.3	-	-	8.6	-	-	28.7
HCM Lane LOS	C	A	-	-	A	-	-	D
HCM 95th %tile Q(veh)	0.4	0.1	-	-	0	-	-	1.4

HCM 6th Signalized Intersection Summary  
 20: Broadway & Leveroni Rd/Napa Rd

Existing plus Project Conditions AM

Movement	EBL	EBT	EBR	WBL	WBT	WBR	NBL	NBT	NBR	SBL	SBT	SBR
Lane Configurations												
Traffic Volume (veh/h)	300	350	81	71	250	270	73	358	123	200	232	80
Future Volume (veh/h)	300	350	81	71	250	270	73	358	123	200	232	80
Initial Q (Qb), veh	0	0	0	0	0	0	0	0	0	0	0	0
Ped-Bike Adj(A_pbT)	1.00		1.00	1.00		1.00	1.00		0.99	1.00		0.99
Parking Bus, Adj	1.00	1.00	1.00	1.00	1.00	1.00	1.00	1.00	1.00	1.00	1.00	1.00
Work Zone On Approach		No			No			No			No	
Adj Sat Flow, veh/h/ln	1870	1870	1870	1870	1870	1870	1870	1870	1870	1870	1870	1870
Adj Flow Rate, veh/h	326	380	81	77	272	261	79	389	104	217	252	58
Peak Hour Factor	0.92	0.92	0.92	0.92	0.92	0.92	0.92	0.92	0.92	0.92	0.92	0.92
Percent Heavy Veh, %	2	2	2	2	2	2	2	2	2	2	2	2
Cap, veh/h	362	618	132	172	268	257	173	499	132	249	641	145
Arrive On Green	0.20	0.41	0.41	0.10	0.31	0.31	0.10	0.18	0.18	0.14	0.22	0.22
Sat Flow, veh/h	1781	1493	318	1781	875	840	1781	2771	732	1781	2873	649
Grp Volume(v), veh/h	326	0	461	77	0	533	79	248	245	217	154	156
Grp Sat Flow(s),veh/h/ln	1781	0	1812	1781	0	1714	1781	1777	1726	1781	1777	1745
Q Serve(g_s), s	18.0	0.0	20.2	4.1	0.0	31.0	4.2	13.4	13.7	12.1	7.5	7.7
Cycle Q Clear(g_c), s	18.0	0.0	20.2	4.1	0.0	31.0	4.2	13.4	13.7	12.1	7.5	7.7
Prop In Lane	1.00		0.18	1.00		0.49	1.00		0.42	1.00		0.37
Lane Grp Cap(c), veh/h	362	0	749	172	0	526	173	320	311	249	396	389
V/C Ratio(X)	0.90	0.00	0.62	0.45	0.00	1.01	0.46	0.77	0.79	0.87	0.39	0.40
Avail Cap(c_a), veh/h	458	0	749	458	0	526	194	475	461	282	475	466
HCM Platoon Ratio	1.00	1.00	1.00	1.00	1.00	1.00	1.00	1.00	1.00	1.00	1.00	1.00
Upstream Filter(I)	1.00	0.00	1.00	1.00	0.00	1.00	1.00	1.00	1.00	1.00	1.00	1.00
Uniform Delay (d), s/veh	39.3	0.0	23.3	43.1	0.0	35.0	43.1	39.5	39.6	42.6	33.4	33.5
Incr Delay (d2), s/veh	17.7	0.0	1.5	1.8	0.0	42.7	1.9	4.6	5.5	22.4	0.6	0.7
Initial Q Delay(d3),s/veh	0.0	0.0	0.0	0.0	0.0	0.0	0.0	0.0	0.0	0.0	0.0	0.0
%ile BackOfQ(50%),veh/ln	9.3	0.0	8.3	1.9	0.0	18.5	1.9	6.0	6.0	6.8	3.2	3.3
Unsig. Movement Delay, s/veh												
LnGrp Delay(d),s/veh	57.0	0.0	24.8	45.0	0.0	77.8	45.0	44.1	45.1	65.0	34.0	34.2
LnGrp LOS	E	A	C	D	A	F	D	D	D	E	C	C
Approach Vol, veh/h		787			610			572			527	
Approach Delay, s/veh		38.1			73.6			44.7			46.8	
Approach LOS		D			E			D			D	
Timer - Assigned Phs	1	2	3	4	5	6	7	8				
Phs Duration (G+Y+Rc), s	13.8	27.5	24.5	35.2	18.1	23.2	13.7	46.0				
Change Period (Y+Rc), s	4.0	5.0	4.0	* 4.2	4.0	5.0	4.0	* 4.2				
Max Green Setting (Gmax), s	11.0	27.0	26.0	* 31	16.0	27.0	26.0	* 31				
Max Q Clear Time (g_c+I1), s	6.2	9.7	20.0	33.0	14.1	15.7	6.1	22.2				
Green Ext Time (p_c), s	0.1	1.5	0.5	0.0	0.1	2.0	0.1	1.7				

Intersection Summary

HCM 6th Ctrl Delay	50.1
HCM 6th LOS	D

Notes

\* HCM 6th computational engine requires equal clearance times for the phases crossing the barrier.

HCM 6th AWSC  
 1: Geyserville Ave & Canyon Road

Existing plus Project Conditions PM

Intersection	
Intersection Delay, s/veh	8.8
Intersection LOS	A

Movement	EBL	EBT	EBR	WBL	WBT	WBR	NBL	NBT	NBR	SBL	SBT	SBR
Lane Configurations		↕			↕			↕			↕	
Traffic Vol, veh/h	40	10	118	10	10	10	146	40	10	10	40	20
Future Vol, veh/h	40	10	118	10	10	10	146	40	10	10	40	20
Peak Hour Factor	0.92	0.92	0.92	0.92	0.92	0.92	0.92	0.92	0.92	0.92	0.92	0.92
Heavy Vehicles, %	2	2	2	2	2	2	2	2	2	2	2	2
Mvmt Flow	43	11	128	11	11	11	159	43	11	11	43	22
Number of Lanes	0	1	0	0	1	0	0	1	0	0	1	0

Approach	EB	WB	NB	SB
Opposing Approach	WB	EB	SB	NB
Opposing Lanes	1	1	1	1
Conflicting Approach Left	SB	NB	EB	WB
Conflicting Lanes Left	1	1	1	1
Conflicting Approach Right	NB	SB	WB	EB
Conflicting Lanes Right	1	1	1	1
HCM Control Delay	8.5	7.9	9.4	8
HCM LOS	A	A	A	A

Lane	NBLn1	EBLn1	WBLn1	SBLn1
Vol Left, %	74%	24%	33%	14%
Vol Thru, %	20%	6%	33%	57%
Vol Right, %	5%	70%	33%	29%
Sign Control	Stop	Stop	Stop	Stop
Traffic Vol by Lane	196	168	30	70
LT Vol	146	40	10	10
Through Vol	40	10	10	40
RT Vol	10	118	10	20
Lane Flow Rate	213	183	33	76
Geometry Grp	1	1	1	1
Degree of Util (X)	0.273	0.217	0.043	0.096
Departure Headway (Hd)	4.619	4.283	4.694	4.521
Convergence, Y/N	Yes	Yes	Yes	Yes
Cap	778	838	762	791
Service Time	2.648	2.307	2.726	2.554
HCM Lane V/C Ratio	0.274	0.218	0.043	0.096
HCM Control Delay	9.4	8.5	7.9	8
HCM Lane LOS	A	A	A	A
HCM 95th-tile Q	1.1	0.8	0.1	0.3

# HCM 6th Signalized Intersection Summary

## 2: Armstrong Woods Rd & River Rd

Existing plus Project Conditions PM



Movement	EBL	EBT	EBR	WBL	WBT	WBR	NBL	NBT	NBR	SBL	SBT	SBR
Lane Configurations												
Traffic Volume (veh/h)	64	360	0	0	430	234	10	36	20	117	0	72
Future Volume (veh/h)	64	360	0	0	430	234	10	36	20	117	0	72
Initial Q (Qb), veh	0	0	0	0	0	0	0	0	0	0	0	0
Ped-Bike Adj(A_pbT)	1.00		1.00	1.00		0.99	0.99		0.99	0.99		0.99
Parking Bus, Adj	1.00	1.00	1.00	1.00	1.00	1.00	1.00	1.00	1.00	1.00	1.00	1.00
Work Zone On Approach	No				No				No			
Adj Sat Flow, veh/h/ln	1870	1870	0	0	1870	1870	1870	1870	1870	1870	1870	1870
Adj Flow Rate, veh/h	70	391	0	0	467	119	11	39	5	127	0	17
Peak Hour Factor	0.92	0.92	0.92	0.92	0.92	0.92	0.92	0.92	0.92	0.92	0.92	0.92
Percent Heavy Veh, %	2	2	0	0	2	2	2	2	2	2	2	2
Cap, veh/h	475	1079	0	0	686	578	429	310	40	408	0	299
Arrive On Green	0.09	0.58	0.00	0.00	0.37	0.37	0.19	0.19	0.19	0.19	0.00	0.19
Sat Flow, veh/h	1781	1870	0	0	1870	1574	1379	1622	208	1346	0	1565
Grp Volume(v), veh/h	70	391	0	0	467	119	11	0	44	127	0	17
Grp Sat Flow(s), veh/h/ln	1781	1870	0	0	1870	1574	1379	0	1830	1346	0	1565
Q Serve(g_s), s	0.8	4.5	0.0	0.0	8.5	2.1	0.3	0.0	0.8	3.5	0.0	0.4
Cycle Q Clear(g_c), s	0.8	4.5	0.0	0.0	8.5	2.1	0.6	0.0	0.8	4.3	0.0	0.4
Prop In Lane	1.00		0.00	0.00		1.00	1.00		0.11	1.00		1.00
Lane Grp Cap(c), veh/h	475	1079	0	0	686	578	429	0	350	408	0	299
V/C Ratio(X)	0.15	0.36	0.00	0.00	0.68	0.21	0.03	0.00	0.13	0.31	0.00	0.06
Avail Cap(c_a), veh/h	614	1476	0	0	3321	2795	777	0	812	748	0	695
HCM Platoon Ratio	1.00	1.00	1.00	1.00	1.00	1.00	1.00	1.00	1.00	1.00	1.00	1.00
Upstream Filter(I)	1.00	1.00	0.00	0.00	1.00	1.00	1.00	0.00	1.00	1.00	0.00	1.00
Uniform Delay (d), s/veh	6.6	4.6	0.0	0.0	10.8	8.8	13.7	0.0	13.6	15.4	0.0	13.4
Incr Delay (d2), s/veh	0.1	0.2	0.0	0.0	1.2	0.2	0.0	0.0	0.2	0.4	0.0	0.1
Initial Q Delay(d3),s/veh	0.0	0.0	0.0	0.0	0.0	0.0	0.0	0.0	0.0	0.0	0.0	0.0
%ile BackOfQ(50%),veh/ln	0.2	1.1	0.0	0.0	3.0	0.6	0.1	0.0	0.3	1.0	0.0	0.1
Unsig. Movement Delay, s/veh												
LnGrp Delay(d),s/veh	6.7	4.8	0.0	0.0	12.0	9.0	13.7	0.0	13.7	15.8	0.0	13.5
LnGrp LOS	A	A	A	A	B	A	B	A	B	B	A	B
Approach Vol, veh/h	461				586				55		144	
Approach Delay, s/veh	5.1				11.4				13.7		15.5	
Approach LOS	A				B				B		B	
Timer - Assigned Phs	2		4		5		6		8			
Phs Duration (G+Y+Rc), s	28.1		12.5		8.5		19.6		12.5			
Change Period (Y+Rc), s	* 4.7		* 4.7		* 4.7		* 4.7		* 4.7			
Max Green Setting (Gmax), s	* 32		* 18		* 7		* 72		* 18			
Max Q Clear Time (g_c+I1), s	6.5		6.3		2.8		10.5		2.8			
Green Ext Time (p_c), s	2.6		0.3		0.0		4.0		0.1			

### Intersection Summary

HCM 6th Ctrl Delay	9.6
HCM 6th LOS	A

### Notes

User approved pedestrian interval to be less than phase max green.  
 \* HCM 6th computational engine requires equal clearance times for the phases crossing the barrier.

# HCM 6th Signalized Intersection Summary

## 3: Gravenstein Hwy/Old River Rd & River Rd

Existing plus Project Conditions PM



Movement	EBL	EBT	EBR	WBL	WBT	WBR	NBL	NBT	NBR	SBL	SBT	SBR
Lane Configurations		↑	↗	↖	↗	↖	↗	↖			↕	
Traffic Volume (veh/h)	0	360	137	60	465	20	169	10	30	20	20	30
Future Volume (veh/h)	0	360	137	60	465	20	169	10	30	20	20	30
Initial Q (Qb), veh	0	0	0	0	0	0	0	0	0	0	0	0
Ped-Bike Adj(A_pbT)	1.00		0.99	1.00		1.00	0.99		1.00	1.00		0.99
Parking Bus, Adj	1.00	1.00	1.00	1.00	1.00	1.00	1.00	1.00	1.00	1.00	1.00	1.00
Work Zone On Approach		No			No			No			No	
Adj Sat Flow, veh/h/ln	0	1870	1870	1870	1870	1870	1870	1870	1870	1870	1870	1870
Adj Flow Rate, veh/h	0	391	94	65	505	20	184	11	8	22	22	8
Peak Hour Factor	0.92	0.92	0.92	0.92	0.92	0.92	0.92	0.92	0.92	0.92	0.92	0.92
Percent Heavy Veh, %	0	2	2	2	2	2	2	2	2	2	2	2
Cap, veh/h	0	575	484	504	972	38	488	218	158	234	200	55
Arrive On Green	0.00	0.31	0.31	0.12	0.54	0.54	0.22	0.22	0.22	0.22	0.22	0.22
Sat Flow, veh/h	0	1870	1572	1781	1786	71	1365	1007	732	478	924	255
Grp Volume(v), veh/h	0	391	94	65	0	525	184	0	19	52	0	0
Grp Sat Flow(s),veh/h/ln	0	1870	1572	1781	0	1857	1365	0	1739	1657	0	0
Q Serve(g_s), s	0.0	7.2	1.7	0.8	0.0	7.0	3.6	0.0	0.3	0.0	0.0	0.0
Cycle Q Clear(g_c), s	0.0	7.2	1.7	0.8	0.0	7.0	4.5	0.0	0.3	0.9	0.0	0.0
Prop In Lane	0.00		1.00	1.00		0.04	1.00		0.42	0.42		0.15
Lane Grp Cap(c), veh/h	0	575	484	504	0	1010	488	0	376	489	0	0
V/C Ratio(X)	0.00	0.68	0.19	0.13	0.00	0.52	0.38	0.00	0.05	0.11	0.00	0.00
Avail Cap(c_a), veh/h	0	1145	962	706	0	1137	1237	0	1330	551	0	0
HCM Platoon Ratio	1.00	1.00	1.00	1.00	1.00	1.00	1.00	1.00	1.00	1.00	1.00	1.00
Upstream Filter(I)	0.00	1.00	1.00	1.00	0.00	1.00	1.00	0.00	1.00	1.00	0.00	0.00
Uniform Delay (d), s/veh	0.0	11.9	10.0	6.8	0.0	5.7	13.7	0.0	12.2	12.4	0.0	0.0
Incr Delay (d2), s/veh	0.0	1.4	0.2	0.1	0.0	0.4	0.5	0.0	0.1	0.1	0.0	0.0
Initial Q Delay(d3),s/veh	0.0	0.0	0.0	0.0	0.0	0.0	0.0	0.0	0.0	0.0	0.0	0.0
%ile BackOfQ(50%),veh/ln	0.0	2.6	0.5	0.2	0.0	1.8	1.3	0.0	0.1	0.3	0.0	0.0
Unsig. Movement Delay, s/veh												
LnGrp Delay(d),s/veh	0.0	13.3	10.2	6.9	0.0	6.1	14.2	0.0	12.2	12.5	0.0	0.0
LnGrp LOS	A	B	B	A	A	A	B	A	B	B	A	A
Approach Vol, veh/h		485			590			203			52	
Approach Delay, s/veh		12.7			6.2			14.0			12.5	
Approach LOS		B			A			B			B	
Timer - Assigned Phs	1	2		4		6		8				
Phs Duration (G+Y+Rc), s	9.3	16.8		13.2		26.0		13.2				
Change Period (Y+Rc), s	4.7	* 4.7		* 4.7		* 4.7		* 4.7				
Max Green Setting (Gmax), s	24	* 24		* 10		* 24		* 30				
Max Q Clear Time (g_c+1), s	9.2	9.2		2.9		9.0		6.5				
Green Ext Time (p_c), s	0.1	2.5		0.1		3.2		0.6				

### Intersection Summary

HCM 6th Ctrl Delay	10.0
HCM 6th LOS	B

### Notes

- User approved pedestrian interval to be less than phase max green.
- \* HCM 6th computational engine requires equal clearance times for the phases crossing the barrier.



HCM 6th TWSC  
 4: Old Redwood Hwy & Fulton Rd

Existing plus Project Conditions PM

Intersection						
Int Delay, s/veh	53					
Movement	EBL	EBR	NBL	NBT	SBT	SBR
Lane Configurations						
Traffic Vol, veh/h	282	50	40	554	445	225
Future Vol, veh/h	282	50	40	554	445	225
Conflicting Peds, #/hr	0	0	0	0	0	0
Sign Control	Stop	Stop	Free	Free	Free	Free
RT Channelized	-	Stop	-	None	-	None
Storage Length	0	90	70	-	-	100
Veh in Median Storage, #	0	-	-	0	0	-
Grade, %	0	-	-	0	0	-
Peak Hour Factor	92	92	92	92	92	92
Heavy Vehicles, %	2	2	2	2	2	2
Mvmt Flow	307	54	43	602	484	245

Major/Minor	Minor2	Major1	Major2			
Conflicting Flow All	1172	484	729	0	-	0
Stage 1	484	-	-	-	-	-
Stage 2	688	-	-	-	-	-
Critical Hdwy	6.42	6.22	4.12	-	-	-
Critical Hdwy Stg 1	5.42	-	-	-	-	-
Critical Hdwy Stg 2	5.42	-	-	-	-	-
Follow-up Hdwy	3.518	3.318	2.218	-	-	-
Pot Cap-1 Maneuver	~ 213	583	875	-	-	-
Stage 1	620	-	-	-	-	-
Stage 2	499	-	-	-	-	-
Platoon blocked, %				-	-	-
Mov Cap-1 Maneuver	~ 203	583	875	-	-	-
Mov Cap-2 Maneuver	~ 203	-	-	-	-	-
Stage 1	590	-	-	-	-	-
Stage 2	499	-	-	-	-	-






















Approach	EB	NB	SB
HCM Control Delay, s	253.5	0.6	0
HCM LOS	F		

Minor Lane/Major Mvmt	NBL	NBT	EBLn1	EBLn2	SBT	SBR
Capacity (veh/h)	875	-	203	583	-	-
HCM Lane V/C Ratio	0.05	-	1.51	0.093	-	-
HCM Control Delay (s)	9.3	-	296.3	11.8	-	-
HCM Lane LOS	A	-	F	B	-	-
HCM 95th %tile Q(veh)	0.2	-	19	0.3	-	-

Notes  
 -: Volume exceeds capacity    \$: Delay exceeds 300s    +: Computation Not Defined    \*: All major volume in platoon

HCM 6th Signalized Intersection Summary  
5: Fulton Rd & Airport Blvd

Existing plus Project Conditions PM

												
Movement	EBL	EBT	EBR	WBL	WBT	WBR	NBL	NBT	NBR	SBL	SBT	SBR
Lane Configurations												
Traffic Volume (veh/h)	161	630	490	122	314	30	430	272	152	40	222	103
Future Volume (veh/h)	161	630	490	122	314	30	430	272	152	40	222	103
Initial Q (Qb), veh	0	0	0	0	0	0	0	0	0	0	0	0
Ped-Bike Adj(A_pbT)	1.00		0.99	1.00		0.99	1.00		0.99	1.00		0.99
Parking Bus, Adj	1.00	1.00	1.00	1.00	1.00	1.00	1.00	1.00	1.00	1.00	1.00	1.00
Work Zone On Approach		No			No			No			No	
Adj Sat Flow, veh/h/ln	1870	1870	1870	1870	1870	1870	1870	1870	1870	1870	1870	1870
Adj Flow Rate, veh/h	175	685	290	133	341	30	467	296	41	43	241	101
Peak Hour Factor	0.92	0.92	0.92	0.92	0.92	0.92	0.92	0.92	0.92	0.92	0.92	0.92
Percent Heavy Veh, %	2	2	2	2	2	2	2	2	2	2	2	2
Cap, veh/h	204	497	417	161	409	36	473	497	417	35	196	82
Arrive On Green	0.11	0.27	0.27	0.09	0.24	0.24	0.27	0.27	0.27	0.18	0.18	0.18
Sat Flow, veh/h	1781	1870	1570	1781	1693	149	1781	1870	1570	198	1109	465
Grp Volume(v), veh/h	175	685	290	133	0	371	467	296	41	385	0	0
Grp Sat Flow(s),veh/h/ln	1781	1870	1570	1781	0	1842	1781	1870	1570	1772	0	0
Q Serve(g_s), s	10.9	30.0	18.8	8.3	0.0	21.6	29.5	15.6	2.2	20.0	0.0	0.0
Cycle Q Clear(g_c), s	10.9	30.0	18.8	8.3	0.0	21.6	29.5	15.6	2.2	20.0	0.0	0.0
Prop In Lane	1.00		1.00	1.00		0.08	1.00		1.00	0.11		0.26
Lane Grp Cap(c), veh/h	204	497	417	161	0	445	473	497	417	314	0	0
V/C Ratio(X)	0.86	1.38	0.70	0.82	0.00	0.83	0.99	0.60	0.10	1.23	0.00	0.00
Avail Cap(c_a), veh/h	315	497	417	309	0	571	473	497	417	314	0	0
HCM Platoon Ratio	1.00	1.00	1.00	1.00	1.00	1.00	1.00	1.00	1.00	1.00	1.00	1.00
Upstream Filter(I)	1.00	1.00	1.00	1.00	0.00	1.00	1.00	1.00	1.00	1.00	0.00	0.00
Uniform Delay (d), s/veh	49.1	41.5	37.3	50.5	0.0	40.7	41.3	36.2	31.3	46.5	0.0	0.0
Incr Delay (d2), s/veh	8.4	182.7	4.2	4.0	0.0	6.7	37.8	1.4	0.0	127.0	0.0	0.0
Initial Q Delay(d3),s/veh	0.0	0.0	0.0	0.0	0.0	0.0	0.0	0.0	0.0	0.0	0.0	0.0
%ile BackOfQ(50%),veh/ln	5.2	38.4	7.4	3.8	0.0	10.3	17.3	7.0	0.8	19.7	0.0	0.0
Unsig. Movement Delay, s/veh												
LnGrp Delay(d),s/veh	57.5	224.1	41.5	54.5	0.0	47.3	79.0	37.5	31.3	173.4	0.0	0.0
LnGrp LOS	E	F	D	D	A	D	E	D	C	F	A	A
Approach Vol, veh/h		1150			504			804			385	
Approach Delay, s/veh		152.7			49.2			61.3			173.4	
Approach LOS		F			D			E			F	
Timer - Assigned Phs	1	2		4	5	6		8				
Phs Duration (G+Y+Rc), s	16.0	36.0		25.1	18.8	33.3		35.8				
Change Period (Y+Rc), s	5.8	6.0		5.1	5.8	6.0		5.8				
Max Green Setting (Gmax), s	19.6	30.0		20.0	20.0	35.0		30.0				
Max Q Clear Time (g_c+I1), s	10.3	32.0		22.0	12.9	23.6		31.5				
Green Ext Time (p_c), s	0.1	0.0		0.0	0.1	1.0		0.0				

Intersection Summary

HCM 6th Ctrl Delay	111.3
HCM 6th LOS	F

Notes

User approved pedestrian interval to be less than phase max green.

# HCM 6th Signalized Intersection Summary

## 6: Old Redwood Hwy & Airport Blvd

Existing plus Project Conditions PM



Movement	EBL	EBT	EBR	WBL	WBT	WBR	NBL	NBT	NBR	SBL	SBT	SBR
Lane Configurations												
Traffic Volume (veh/h)	70	161	411	20	91	30	245	544	20	50	404	50
Future Volume (veh/h)	70	161	411	20	91	30	245	544	20	50	404	50
Initial Q (Qb), veh	0	0	0	0	0	0	0	0	0	0	0	0
Ped-Bike Adj(A_pbT)	1.00		1.00	1.00		1.00	1.00		1.00	1.00		1.00
Parking Bus, Adj	1.00	1.00	1.00	1.00	1.00	1.00	1.00	1.00	1.00	1.00	1.00	1.00
Work Zone On Approach		No			No			No			No	
Adj Sat Flow, veh/h/ln	1870	1870	1870	1870	1870	1870	1870	1870	1870	1870	1870	1870
Adj Flow Rate, veh/h	76	175	92	22	99	20	266	591	11	54	439	54
Peak Hour Factor	0.92	0.92	0.92	0.92	0.92	0.92	0.92	0.92	0.92	0.92	0.92	0.92
Percent Heavy Veh, %	2	2	2	2	2	2	2	2	2	2	2	2
Cap, veh/h	96	254	215	37	132	27	321	776	657	74	517	438
Arrive On Green	0.05	0.14	0.14	0.02	0.09	0.09	0.18	0.41	0.41	0.04	0.28	0.28
Sat Flow, veh/h	1781	1870	1585	1781	1510	305	1781	1870	1585	1781	1870	1585
Grp Volume(v), veh/h	76	175	92	22	0	119	266	591	11	54	439	54
Grp Sat Flow(s),veh/h/ln	1781	1870	1585	1781	0	1815	1781	1870	1585	1781	1870	1585
Q Serve(g_s), s	2.2	4.7	2.8	0.6	0.0	3.3	7.5	14.1	0.2	1.6	11.6	1.3
Cycle Q Clear(g_c), s	2.2	4.7	2.8	0.6	0.0	3.3	7.5	14.1	0.2	1.6	11.6	1.3
Prop In Lane	1.00		1.00	1.00		0.17	1.00		1.00	1.00		1.00
Lane Grp Cap(c), veh/h	96	254	215	37	0	159	321	776	657	74	517	438
V/C Ratio(X)	0.79	0.69	0.43	0.59	0.00	0.75	0.83	0.76	0.02	0.73	0.85	0.12
Avail Cap(c_a), veh/h	409	1433	1214	409	0	904	682	1075	911	341	1075	911
HCM Platoon Ratio	1.00	1.00	1.00	1.00	1.00	1.00	1.00	1.00	1.00	1.00	1.00	1.00
Upstream Filter(I)	1.00	1.00	1.00	1.00	0.00	1.00	1.00	1.00	1.00	1.00	1.00	1.00
Uniform Delay (d), s/veh	24.4	21.5	20.7	25.3	0.0	23.3	20.6	13.1	9.0	24.7	17.9	14.2
Incr Delay (d2), s/veh	5.4	1.2	0.5	5.4	0.0	2.6	2.1	1.3	0.0	5.0	1.5	0.0
Initial Q Delay(d3),s/veh	0.0	0.0	0.0	0.0	0.0	0.0	0.0	0.0	0.0	0.0	0.0	0.0
%ile BackOfQ(50%),veh/ln	0	1.9	0.9	0.3	0.0	1.5	2.9	4.9	0.1	0.7	4.5	0.4
Unsig. Movement Delay, s/veh												
LnGrp Delay(d),s/veh	29.8	22.7	21.2	30.8	0.0	25.9	22.8	14.3	9.0	29.7	19.4	14.2
LnGrp LOS	C	C	C	C	A	C	C	B	A	C	B	B
Approach Vol, veh/h		343			141			868			547	
Approach Delay, s/veh		23.9			26.6			16.8			19.9	
Approach LOS		C			C			B			B	
Timer - Assigned Phs	1	2	3	4	5	6	7	8				
Phs Duration (G+Y+Rc), s	5.7	12.5	14.5	19.5	8.2	10.0	7.3	26.7				
Change Period (Y+Rc), s	4.6	5.4	5.1	5.1	5.4	* 5.4	5.1	5.1				
Max Green Setting (Gmax)	12.0	40.0	20.0	30.0	12.0	* 26	10.0	30.0				
Max Q Clear Time (g_c+1)	12.6	6.7	9.5	13.6	4.2	5.3	3.6	16.1				
Green Ext Time (p_c), s	0.0	0.3	0.1	0.8	0.0	0.2	0.0	1.1				

### Intersection Summary

HCM 6th Ctrl Delay	19.7
HCM 6th LOS	B

### Notes

- User approved pedestrian interval to be less than phase max green.
- \* HCM 6th computational engine requires equal clearance times for the phases crossing the barrier.

HCM 6th TWSC

7: Old Redwood Hwy & Creekside Apts/Faught Rd

Existing plus Project Conditions PM

Intersection												
Int Delay, s/veh	24.7											
Movement	EBL	EBT	EBR	WBL	WBT	WBR	NBL	NBT	NBR	SBL	SBT	SBR
Lane Configurations		↕			↕		↕	↑	↑	↑		↕
Traffic Vol, veh/h	10	10	20	71	10	20	20	709	122	30	715	30
Future Vol, veh/h	10	10	20	71	10	20	20	709	122	30	715	30
Conflicting Peds, #/hr	0	0	0	0	0	0	0	0	0	0	0	0
Sign Control	Stop	Stop	Stop	Stop	Stop	Stop	Free	Free	Free	Free	Free	Free
RT Channelized	-	-	None	-	-	None	-	-	None	-	-	None
Storage Length	-	-	-	-	-	-	50	-	270	-	-	-
Veh in Median Storage, #	-	0	-	-	0	-	-	0	-	-	0	-
Grade, %	-	0	-	-	0	-	-	0	-	-	0	-
Peak Hour Factor	92	92	92	92	92	92	92	92	92	92	92	92
Heavy Vehicles, %	2	2	2	2	2	2	2	2	2	2	2	2
Mvmt Flow	11	11	22	77	11	22	22	771	133	33	777	33

Major/Minor	Minor2		Minor1		Major1		Major2					
Conflicting Flow All	1758	1808	794	1691	1691	771	810	0	0	904	0	0
Stage 1	860	860	-	815	815	-	-	-	-	-	-	-
Stage 2	898	948	-	876	876	-	-	-	-	-	-	-
Critical Hdwy	7.12	6.52	6.22	7.12	6.52	6.22	4.12	-	-	4.12	-	-
Critical Hdwy Stg 1	6.12	5.52	-	6.12	5.52	-	-	-	-	-	-	-
Critical Hdwy Stg 2	6.12	5.52	-	6.12	5.52	-	-	-	-	-	-	-
Follow-up Hdwy	3.518	4.018	3.318	3.518	4.018	3.318	2.218	-	-	2.218	-	-
Pot Cap-1 Maneuver	66	79	388	~ 74	93	400	816	-	-	752	-	-
Stage 1	351	373	-	371	391	-	-	-	-	-	-	-
Stage 2	334	339	-	344	367	-	-	-	-	-	-	-
Platoon blocked, %								-	-	-	-	-
Mov Cap-1 Maneuver	52	71	388	~ 57	83	400	816	-	-	752	-	-
Mov Cap-2 Maneuver	52	71	-	~ 57	83	-	-	-	-	-	-	-
Stage 1	342	343	-	361	380	-	-	-	-	-	-	-
Stage 2	299	330	-	289	338	-	-	-	-	-	-	-






















Approach	EB		WB		NB		SB	
HCM Control Delay, s	62.5		\$ 403.1		0.2		0.4	
HCM LOS	F		F					

Minor Lane/Major Mvmt	NBL	NBT	NBR	EBLn1WBLn1	SBL	SBT	SBR
Capacity (veh/h)	816	-	-	104	71	752	-
HCM Lane V/C Ratio	0.027	-	-	0.418	1.546	0.043	-
HCM Control Delay (s)	9.5	-	-	62.5	\$ 403.1	10	0
HCM Lane LOS	A	-	-	F	F	B	A
HCM 95th %tile Q(veh)	0.1	-	-	1.8	9.3	0.1	-

Notes  
 -: Volume exceeds capacity    \$: Delay exceeds 300s    +: Computation Not Defined    \*: All major volume in platoon

HCM 6th Signalized Intersection Summary  
 8: Old Redwood Hwy & Mark West Commons Cir/Wikiup Dr

Existing plus Project Conditions PM

												
Movement	EBL	EBT	EBR	WBL	WBT	WBR	NBL	NBT	NBR	SBL	SBT	SBR
Lane Configurations												
Traffic Volume (veh/h)	10	10	10	159	10	128	30	694	176	95	651	10
Future Volume (veh/h)	10	10	10	159	10	128	30	694	176	95	651	10
Initial Q (Qb), veh	0	0	0	0	0	0	0	0	0	0	0	0
Ped-Bike Adj(A_pbT)	0.99		0.99	0.99		0.99	1.00		0.99	1.00		0.99
Parking Bus, Adj	1.00	1.00	1.00	1.00	1.00	1.00	1.00	1.00	1.00	1.00	1.00	1.00
Work Zone On Approach		No			No			No			No	
Adj Sat Flow, veh/h/ln	1870	1870	1870	1870	1870	1870	1870	1870	1870	1870	1870	1870
Adj Flow Rate, veh/h	11	11	2	173	11	41	33	754	118	103	708	6
Peak Hour Factor	0.92	0.92	0.92	0.92	0.92	0.92	0.92	0.92	0.92	0.92	0.92	0.92
Percent Heavy Veh, %	2	2	2	2	2	2	2	2	2	2	2	2
Cap, veh/h	135	109	13	363	15	317	52	837	705	132	922	777
Arrive On Green	0.20	0.20	0.20	0.20	0.20	0.20	0.03	0.45	0.45	0.07	0.49	0.49
Sat Flow, veh/h	186	539	66	1151	73	1565	1781	1870	1576	1781	1870	1577
Grp Volume(v), veh/h	24	0	0	184	0	41	33	754	118	103	708	6
Grp Sat Flow(s),veh/h/ln	791	0	0	1224	0	1565	1781	1870	1576	1781	1870	1577
Q Serve(g_s), s	0.1	0.0	0.0	0.0	0.0	1.2	1.0	20.0	2.4	3.1	16.6	0.1
Cycle Q Clear(g_c), s	8.2	0.0	0.0	8.1	0.0	1.2	1.0	20.0	2.4	3.1	16.6	0.1
Prop In Lane	0.46		0.08	0.94		1.00	1.00		1.00	1.00		1.00
Lane Grp Cap(c), veh/h	258	0	0	378	0	317	52	837	705	132	922	777
V/C Ratio(X)	0.09	0.00	0.00	0.49	0.00	0.13	0.64	0.90	0.17	0.78	0.77	0.01
Avail Cap(c_a), veh/h	290	0	0	749	0	729	398	1045	880	398	1045	881
HCM Platoon Ratio	1.00	1.00	1.00	1.00	1.00	1.00	1.00	1.00	1.00	1.00	1.00	1.00
Upstream Filter(I)	1.00	0.00	0.00	1.00	0.00	1.00	1.00	1.00	1.00	1.00	1.00	1.00
Uniform Delay (d), s/veh	17.6	0.0	0.0	20.3	0.0	17.5	25.8	13.7	8.9	24.4	11.1	6.9
Incr Delay (d2), s/veh	0.1	0.0	0.0	0.4	0.0	0.1	4.8	8.1	0.0	3.7	2.6	0.0
Initial Q Delay(d3),s/veh	0.0	0.0	0.0	0.0	0.0	0.0	0.0	0.0	0.0	0.0	0.0	0.0
%ile BackOfQ(50%),veh/ln	0.2	0.0	0.0	2.1	0.0	0.4	0.5	8.3	0.7	1.3	5.8	0.0
Unsig. Movement Delay, s/veh												
LnGrp Delay(d),s/veh	17.7	0.0	0.0	20.7	0.0	17.6	30.6	21.8	8.9	28.1	13.7	6.9
LnGrp LOS	B	A	A	C	A	B	C	C	A	C	B	A
Approach Vol, veh/h		24			225			905			817	
Approach Delay, s/veh		17.7			20.1			20.4			15.4	
Approach LOS		B			C			C			B	
Timer - Assigned Phs		2	3	4		6	7	8				
Phs Duration (G+Y+Rc), s		15.5	6.7	31.6		15.5	9.1	29.1				
Change Period (Y+Rc), s		4.6	5.1	5.1		4.6	5.1	5.1				
Max Green Setting (Gmax), s		12.0	12.0	30.0		25.0	12.0	30.0				
Max Q Clear Time (g_c+I1), s		10.2	3.0	18.6		10.1	5.1	22.0				
Green Ext Time (p_c), s		0.0	0.0	1.9		0.7	0.0	1.9				
<b>Intersection Summary</b>												
HCM 6th Ctrl Delay				18.3								
HCM 6th LOS				B								
<b>Notes</b>												
User approved pedestrian interval to be less than phase max green.												

**Intersection**

Int Delay, s/veh 5.4

Movement	EBL	EBT	WBT	WBR	SBL	SBR
Lane Configurations		↕	↑	↗	↖	↗
Traffic Vol, veh/h	32	185	199	423	273	50
Future Vol, veh/h	32	185	199	423	273	50
Conflicting Peds, #/hr	0	0	0	0	0	0
Sign Control	Free	Free	Free	Free	Stop	Stop
RT Channelized	-	None	-	Yield	-	None
Storage Length	-	-	-	150	90	0
Veh in Median Storage, #	-	0	0	-	0	-
Grade, %	-	0	0	-	0	-
Peak Hour Factor	92	92	92	92	92	92
Heavy Vehicles, %	2	2	2	2	2	2
Mvmt Flow	35	201	216	460	297	54

Major/Minor	Major1	Major2	Minor2		
Conflicting Flow All	216	0	-	0	487 216
Stage 1	-	-	-	-	216 -
Stage 2	-	-	-	-	271 -
Critical Hdwy	4.12	-	-	-	6.42 6.22
Critical Hdwy Stg 1	-	-	-	-	5.42 -
Critical Hdwy Stg 2	-	-	-	-	5.42 -
Follow-up Hdwy	2.218	-	-	-	3.518 3.318
Pot Cap-1 Maneuver	1354	-	-	-	540 824
Stage 1	-	-	-	-	820 -
Stage 2	-	-	-	-	775 -
Platoon blocked, %		-	-	-	
Mov Cap-1 Maneuver	1354	-	-	-	524 824
Mov Cap-2 Maneuver	-	-	-	-	524 -
Stage 1	-	-	-	-	796 -
Stage 2	-	-	-	-	775 -

Approach	EB	WB	SB
HCM Control Delay, s	1.1	0	18.8
HCM LOS			C

Minor Lane/Major Mvmt	EBL	EBT	WBT	WBR	SBLn1	SBLn2
Capacity (veh/h)	1354	-	-	-	524	824
HCM Lane V/C Ratio	0.026	-	-	-	0.566	0.066
HCM Control Delay (s)	7.7	0	-	-	20.5	9.7
HCM Lane LOS	A	A	-	-	C	A
HCM 95th %tile Q(veh)	0.1	-	-	-	3.5	0.2

HCM 6th Signalized Intersection Summary  
 10: Gravenstein Hwy & Graton Rd/Frei Rd

Existing plus Project Conditions PM



Movement	EBL	EBT	EBR	WBL	WBT	WBR	NBL	NBT	NBR	SBL	SBT	SBR
Lane Configurations		↖	↗		↔		↖	↗		↖	↗	
Traffic Volume (veh/h)	20	21	88	150	41	11	136	438	70	10	363	30
Future Volume (veh/h)	20	21	88	150	41	11	136	438	70	10	363	30
Initial Q (Qb), veh	0	0	0	0	0	0	0	0	0	0	0	0
Ped-Bike Adj(A_pbT)	0.99		0.99	0.99		0.99	1.00		0.99	1.00		0.99
Parking Bus, Adj	1.00	1.00	1.00	1.00	1.00	1.00	1.00	1.00	1.00	1.00	1.00	1.00
Work Zone On Approach		No			No			No			No	
Adj Sat Flow, veh/h/ln	1870	1870	1870	1870	1870	1870	1870	1870	1870	1870	1870	1870
Adj Flow Rate, veh/h	22	23	23	163	45	10	148	476	74	11	395	30
Peak Hour Factor	0.92	0.92	0.92	0.92	0.92	0.92	0.92	0.92	0.92	0.92	0.92	0.92
Percent Heavy Veh, %	2	2	2	2	2	2	2	2	2	2	2	2
Cap, veh/h	238	216	328	322	73	13	354	727	113	60	507	38
Arrive On Green	0.21	0.21	0.21	0.21	0.21	0.21	0.20	0.46	0.46	0.03	0.30	0.30
Sat Flow, veh/h	660	1030	1566	975	348	64	1781	1579	245	1781	1715	130
Grp Volume(v), veh/h	45	0	23	218	0	0	148	0	550	11	0	425
Grp Sat Flow(s),veh/h/ln	1690	0	1566	1387	0	0	1781	0	1825	1781	0	1846
Q Serve(g_s), s	0.0	0.0	0.6	7.0	0.0	0.0	3.9	0.0	12.5	0.3	0.0	11.3
Cycle Q Clear(g_c), s	1.0	0.0	0.6	8.1	0.0	0.0	3.9	0.0	12.5	0.3	0.0	11.3
Prop In Lane	0.49		1.00	0.75		0.05	1.00		0.13	1.00		0.07
Lane Grp Cap(c), veh/h	454	0	328	408	0	0	354	0	840	60	0	545
V/C Ratio(X)	0.10	0.00	0.07	0.53	0.00	0.00	0.42	0.00	0.65	0.18	0.00	0.78
Avail Cap(c_a), veh/h	1584	0	1458	535	0	0	531	0	1699	1658	0	859
HCM Platoon Ratio	1.00	1.00	1.00	1.00	1.00	1.00	1.00	1.00	1.00	1.00	1.00	1.00
Upstream Filter(I)	1.00	0.00	1.00	1.00	0.00	0.00	1.00	0.00	1.00	1.00	0.00	1.00
Uniform Delay (d), s/veh	17.2	0.0	17.0	20.1	0.0	0.0	18.8	0.0	11.2	25.2	0.0	17.3
Incr Delay (d2), s/veh	0.1	0.0	0.1	1.1	0.0	0.0	0.8	0.0	0.9	1.4	0.0	2.5
Initial Q Delay(d3),s/veh	0.0	0.0	0.0	0.0	0.0	0.0	0.0	0.0	0.0	0.0	0.0	0.0
%ile BackOfQ(50%),veh/ln	0.4	0.0	0.2	2.3	0.0	0.0	1.4	0.0	3.7	0.1	0.0	4.2
Unsig. Movement Delay, s/veh												
LnGrp Delay(d),s/veh	17.3	0.0	17.1	21.2	0.0	0.0	19.6	0.0	12.1	26.7	0.0	19.8
LnGrp LOS	B	A	B	C	A	A	B	A	B	C	A	B
Approach Vol, veh/h		68			218			698				436
Approach Delay, s/veh		17.2			21.2			13.7				20.0
Approach LOS		B			C			B				B
Timer - Assigned Phs	1	2		4	5	6		8				
Phs Duration (G+Y+Rc), s	15.4	21.7		16.7	6.5	30.5		16.7				
Change Period (Y+Rc), s	* 4.7	5.8		5.4	* 4.7	5.8		5.4				
Max Green Setting (Gmax), s	* 16	25.0		16.0	* 50	50.0		50.0				
Max Q Clear Time (g_c+I1), s	5.9	13.3		10.1	2.3	14.5		3.0				
Green Ext Time (p_c), s	0.2	1.8		0.5	0.0	3.6		0.3				

Intersection Summary

HCM 6th Ctrl Delay	16.9
HCM 6th LOS	B

Notes

- User approved pedestrian interval to be less than phase max green.
- \* HCM 6th computational engine requires equal clearance times for the phases crossing the barrier.

HCM 6th TWSC  
 11: Private Dwy/Moorland Ave & Todd Rd

Existing plus Project Conditions PM

Intersection												
Int Delay, s/veh	591.4											
Movement	EBL	EBT	EBR	WBL	WBT	WBR	NBL	NBT	NBR	SBL	SBT	SBR
Lane Configurations	↖	↗		↖	↗			↕			↖	↗
Traffic Vol, veh/h	52	588	10	20	495	380	10	20	20	395	20	32
Future Vol, veh/h	52	588	10	20	495	380	10	20	20	395	20	32
Conflicting Peds, #/hr	0	0	0	0	0	0	0	0	0	0	0	0
Sign Control	Free	Free	Free	Free	Free	Free	Stop	Stop	Stop	Stop	Stop	Stop
RT Channelized	-	-	None	-	-	None	-	-	None	-	-	None
Storage Length	100	-	-	70	-	-	-	-	-	-	-	60
Veh in Median Storage, #	-	0	-	-	0	-	-	0	-	-	0	-
Grade, %	-	0	-	-	0	-	-	0	-	-	0	-
Peak Hour Factor	92	92	92	92	92	92	92	92	92	92	92	92
Heavy Vehicles, %	2	2	2	2	2	2	2	2	2	2	2	2
Mvmt Flow	57	639	11	22	538	413	11	22	22	429	22	35

Major/Minor	Major1			Major2			Minor1			Minor2		
Conflicting Flow All	951	0	0	650	0	0	1576	1754	645	1570	1553	745
Stage 1	-	-	-	-	-	-	759	759	-	789	789	-
Stage 2	-	-	-	-	-	-	817	995	-	781	764	-
Critical Hdwy	4.12	-	-	4.12	-	-	7.12	6.52	6.22	7.12	6.52	6.22
Critical Hdwy Stg 1	-	-	-	-	-	-	6.12	5.52	-	6.12	5.52	-
Critical Hdwy Stg 2	-	-	-	-	-	-	6.12	5.52	-	6.12	5.52	-
Follow-up Hdwy	2.218	-	-	2.218	-	-	3.518	4.018	3.318	3.518	4.018	3.318
Pot Cap-1 Maneuver	722	-	-	936	-	-	89	85	472	~ 90	113	414
Stage 1	-	-	-	-	-	-	399	415	-	~ 384	402	-
Stage 2	-	-	-	-	-	-	370	323	-	~ 388	413	-
Platoon blocked, %		-	-		-	-						
Mov Cap-1 Maneuver	722	-	-	936	-	-	63	76	472	~ 62	102	414
Mov Cap-2 Maneuver	-	-	-	-	-	-	63	76	-	~ 62	102	-
Stage 1	-	-	-	-	-	-	367	382	-	~ 354	392	-
Stage 2	-	-	-	-	-	-	313	315	-	~ 322	380	-

Approach	EB			WB			NB			SB		
HCM Control Delay, s	0.8			0.2			68.1			\$ 2692.6		
HCM LOS							F			F		

Minor Lane/Major Mvmt	NBLn1	EBL	EBT	EBR	WBL	WBT	WBR	SBLn1	SBLn2
Capacity (veh/h)	108	722	-	-	936	-	-	63	414
HCM Lane V/C Ratio	0.503	0.078	-	-	0.023	-	-	7.16	0.084
HCM Control Delay (s)	68.1	10.4	-	-	8.9	-	-	\$ 2899.1	14.5
HCM Lane LOS	F	B	-	-	A	-	-	F	B
HCM 95th %tile Q(veh)	2.3	0.3	-	-	0.1	-	-	51.8	0.3





















Notes  
 -: Volume exceeds capacity    \$: Delay exceeds 300s    +: Computation Not Defined    \*: All major volume in platoon



# HCM 6th Signalized Intersection Summary

## 12: S Moreland Ave & Todd Rd

Existing plus Project Conditions PM

												
Movement	EBL	EBT	EBR	WBL	WBT	WBR	NBL	NBT	NBR	SBL	SBT	SBR
Lane Configurations												
Traffic Volume (veh/h)	0	425	578	380	273	0	622	0	127	0	0	0
Future Volume (veh/h)	0	425	578	380	273	0	622	0	127	0	0	0
Initial Q (Qb), veh	0	0	0	0	0	0	0	0	0	0	0	0
Ped-Bike Adj(A_pbT)	1.00		1.00	1.00		1.00	1.00		1.00	1.00		1.00
Parking Bus, Adj	1.00	1.00	1.00	1.00	1.00	1.00	1.00	1.00	1.00	1.00	1.00	1.00
Work Zone On Approach		No			No			No			No	
Adj Sat Flow, veh/h/ln	1870	1870	1870	1870	1870	1870	1870	1870	1870	1870	1870	1870
Adj Flow Rate, veh/h	0	462	339	413	297	0	676	0	91	0	0	0
Peak Hour Factor	0.92	0.92	0.92	0.92	0.92	0.92	0.92	0.92	0.92	0.92	0.92	0.92
Percent Heavy Veh, %	2	2	2	2	2	2	2	2	2	2	2	2
Cap, veh/h	0	499	423	494	519	0	594	0	1057	0	2	0
Arrive On Green	0.00	0.27	0.27	0.28	0.28	0.00	0.33	0.00	0.33	0.00	0.00	0.00
Sat Flow, veh/h	0	1870	1585	1781	1870	0	1781	0	3170	0	1870	0
Grp Volume(v), veh/h	0	462	339	413	297	0	676	0	91	0	0	0
Grp Sat Flow(s),veh/h/ln	0	1870	1585	1781	1870	0	1781	0	1585	0	1870	0
Q Serve(g_s), s	0.0	18.0	15.0	16.4	10.2	0.0	25.0	0.0	1.5	0.0	0.0	0.0
Cycle Q Clear(g_c), s	0.0	18.0	15.0	16.4	10.2	0.0	25.0	0.0	1.5	0.0	0.0	0.0
Prop In Lane	0.00		1.00	1.00		0.00	1.00		1.00	0.00		0.00
Lane Grp Cap(c), veh/h	0	499	423	494	519	0	594	0	1057	0	2	0
V/C Ratio(X)	0.00	0.93	0.80	0.84	0.57	0.00	1.14	0.00	0.09	0.00	0.00	0.00
Avail Cap(c_a), veh/h	0	499	423	713	748	0	594	0	1057	0	200	0
HCM Platoon Ratio	1.00	1.00	1.00	1.00	1.00	1.00	1.00	1.00	1.00	1.00	1.00	1.00
Upstream Filter(I)	0.00	1.00	1.00	1.00	1.00	0.00	1.00	0.00	1.00	0.00	0.00	0.00
Uniform Delay (d), s/veh	0.0	26.8	25.7	25.5	23.3	0.0	25.0	0.0	17.2	0.0	0.0	0.0
Incr Delay (d2), s/veh	0.0	23.5	10.6	5.9	1.0	0.0	81.4	0.0	0.0	0.0	0.0	0.0
Initial Q Delay(d3),s/veh	0.0	0.0	0.0	0.0	0.0	0.0	0.0	0.0	0.0	0.0	0.0	0.0
%ile BackOfQ(50%),veh/ln	0.0	10.7	6.5	7.2	4.4	0.0	23.2	0.0	0.5	0.0	0.0	0.0
Unsig. Movement Delay, s/veh												
LnGrp Delay(d),s/veh	0.0	50.3	36.3	31.4	24.3	0.0	106.4	0.0	17.2	0.0	0.0	0.0
LnGrp LOS	A	D	D	C	C	A	F	A	B	A	A	A
Approach Vol, veh/h		801			710			767				0
Approach Delay, s/veh		44.3			28.4			95.8				0.0
Approach LOS		D			C			F				
Timer - Assigned Phs		2		4		6		8				
Phs Duration (G+Y+Rc), s		0.0		23.2		28.0		23.8				
Change Period (Y+Rc), s		3.0		3.2		3.0		3.0				
Max Green Setting (Gmax), s		8.0		20.0		25.0		30.0				
Max Q Clear Time (g_c+I1), s		0.0		20.0		27.0		18.4				
Green Ext Time (p_c), s		0.0		0.0		0.0		2.4				

### Intersection Summary

HCM 6th Ctrl Delay	56.7
HCM 6th LOS	E

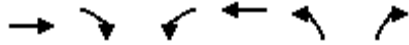
### Notes

- User approved pedestrian interval to be less than phase max green.
- User approved volume balancing among the lanes for turning movement.

# HCM 6th Signalized Intersection Summary

## 13: Todd Rd Overpass & Todd Rd

Existing plus Project Conditions PM



Movement	EBT	EBR	WBL	WBT	NBL	NBR
Lane Configurations	↑↑	↑	↑	↑↑	↑	↑↑
Traffic Volume (veh/h)	245	315	414	388	285	723
Future Volume (veh/h)	245	315	414	388	285	723
Initial Q (Qb), veh	0	0	0	0	0	0
Ped-Bike Adj(A_pbT)		1.00	1.00		1.00	1.00
Parking Bus, Adj	1.00	1.00	1.00	1.00	1.00	1.00
Work Zone On Approach	No			No	No	
Adj Sat Flow, veh/h/ln	1870	1870	1870	1870	1870	1870
Adj Flow Rate, veh/h	266	74	487	370	310	486
Peak Hour Factor	0.92	0.92	0.92	0.92	0.92	0.92
Percent Heavy Veh, %	2	2	2	2	2	2
Cap, veh/h	577	257	1044	548	461	1539
Arrive On Green	0.16	0.16	0.29	0.29	0.26	0.26
Sat Flow, veh/h	3647	1585	3563	1870	1781	2790
Grp Volume(v), veh/h	266	74	487	370	310	486
Grp Sat Flow(s),veh/h/ln	1777	1585	1781	1870	1781	1395
Q Serve(g_s), s	2.5	1.5	4.1	6.4	5.7	3.5
Cycle Q Clear(g_c), s	2.5	1.5	4.1	6.4	5.7	3.5
Prop In Lane		1.00	1.00		1.00	1.00
Lane Grp Cap(c), veh/h	577	257	1044	548	461	1539
V/C Ratio(X)	0.46	0.29	0.47	0.68	0.67	0.32
Avail Cap(c_a), veh/h	1934	863	1454	764	679	1880
HCM Platoon Ratio	1.00	1.00	1.00	1.00	1.00	1.00
Upstream Filter(I)	1.00	1.00	1.00	1.00	1.00	1.00
Uniform Delay (d), s/veh	13.9	13.5	10.6	11.4	12.2	4.5
Incr Delay (d2), s/veh	0.6	0.6	0.3	1.5	1.7	0.1
Initial Q Delay(d3),s/veh	0.0	0.0	0.0	0.0	0.0	0.0
%ile BackOfQ(50%),veh/ln	0.9	0.5	1.3	2.2	2.0	1.4
Unsig. Movement Delay, s/veh						
LnGrp Delay(d),s/veh	14.5	14.1	11.0	12.9	13.9	4.6
LnGrp LOS	B	B	B	B	B	A
Approach Vol, veh/h	340			857	796	
Approach Delay, s/veh	14.4			11.8	8.2	
Approach LOS	B			B	A	
Timer - Assigned Phs		2			6	8
Phs Duration (G+Y+Rc), s		9.5			14.3	13.0
Change Period (Y+Rc), s		3.5			3.5	3.5
Max Green Setting (Gmax), s		20.0			15.0	14.0
Max Q Clear Time (g_c+I1), s		4.5			8.4	7.7
Green Ext Time (p_c), s		1.7			2.4	1.8

### Intersection Summary

HCM 6th Ctrl Delay	10.8
HCM 6th LOS	B

### Notes

User approved volume balancing among the lanes for turning movement.

# HCM 6th Signalized Intersection Summary

## 14: Santa Rosa Ave & Todd Rd

Existing plus Project Conditions PM



Movement	EBL	EBT	EBR	WBL	WBT	WBR	NBL	NBT	NBR	SBL	SBT	SBR
Lane Configurations												
Traffic Volume (veh/h)	533	60	375	50	100	60	367	615	40	30	533	335
Future Volume (veh/h)	533	60	375	50	100	60	367	615	40	30	533	335
Initial Q (Qb), veh	0	0	0	0	0	0	0	0	0	0	0	0
Ped-Bike Adj(A_pbT)	1.00		0.99	1.00		1.00	1.00		0.99	1.00		0.99
Parking Bus, Adj	1.00	1.00	1.00	1.00	1.00	1.00	1.00	1.00	1.00	1.00	1.00	1.00
Work Zone On Approach		No			No			No			No	
Adj Sat Flow, veh/h/ln	1870	1870	1870	1870	1870	1870	1870	1870	1870	1870	1870	1870
Adj Flow Rate, veh/h	625	0	201	54	109	38	399	668	17	33	579	84
Peak Hour Factor	0.92	0.92	0.92	0.92	0.92	0.92	0.92	0.92	0.92	0.92	0.92	0.92
Percent Heavy Veh, %	2	2	2	2	2	2	2	2	2	2	2	2
Cap, veh/h	728	0	322	189	141	49	399	1373	608	47	684	303
Arrive On Green	0.20	0.00	0.20	0.11	0.11	0.11	0.22	0.39	0.39	0.03	0.19	0.19
Sat Flow, veh/h	3563	0	1573	1781	1325	462	1781	3554	1575	1781	3554	1573
Grp Volume(v), veh/h	625	0	201	54	0	147	399	668	17	33	579	84
Grp Sat Flow(s),veh/h/ln	1781	0	1573	1781	0	1787	1781	1777	1575	1781	1777	1573
Q Serve(g_s), s	12.8	0.0	8.8	2.1	0.0	6.1	17.0	10.8	0.5	1.4	11.9	3.5
Cycle Q Clear(g_c), s	12.8	0.0	8.8	2.1	0.0	6.1	17.0	10.8	0.5	1.4	11.9	3.5
Prop In Lane	1.00		1.00	1.00		0.26	1.00		1.00	1.00		1.00
Lane Grp Cap(c), veh/h	728	0	322	189	0	190	399	1373	608	47	684	303
V/C Ratio(X)	0.86	0.00	0.63	0.29	0.00	0.78	1.00	0.49	0.03	0.70	0.85	0.28
Avail Cap(c_a), veh/h	845	0	373	235	0	236	399	1373	608	235	750	332
HCM Platoon Ratio	1.00	1.00	1.00	1.00	1.00	1.00	1.00	1.00	1.00	1.00	1.00	1.00
Upstream Filter(I)	1.00	0.00	1.00	1.00	0.00	1.00	1.00	1.00	1.00	1.00	1.00	1.00
Uniform Delay (d), s/veh	29.1	0.0	27.5	31.2	0.0	33.0	29.4	17.6	14.4	36.6	29.5	26.1
Incr Delay (d2), s/veh	7.0	0.0	1.4	0.3	0.0	9.2	44.9	0.1	0.0	6.8	7.6	0.2
Initial Q Delay(d3),s/veh	0.0	0.0	0.0	0.0	0.0	0.0	0.0	0.0	0.0	0.0	0.0	0.0
%ile BackOfQ(50%),veh/ln	0.0	0.0	3.3	0.9	0.0	3.1	11.8	4.1	0.2	0.7	5.4	1.2
Unsig. Movement Delay, s/veh												
LnGrp Delay(d),s/veh	36.1	0.0	28.9	31.6	0.0	42.2	74.3	17.7	14.4	43.5	37.1	26.3
LnGrp LOS	D	A	C	C	A	D	E	B	B	D	D	C
Approach Vol, veh/h		826			201			1084			696	
Approach Delay, s/veh		34.4			39.4			38.5			36.1	
Approach LOS		C			D			D			D	
Timer - Assigned Phs		2	3	4		6	7	8				
Phs Duration (G+Y+Rc), s		20.6	22.1	20.0		13.1	7.4	34.7				
Change Period (Y+Rc), s		5.1	5.1	5.4		5.1	5.4	* 5.4				
Max Green Setting (Gmax), s		18.0	17.0	16.0		10.0	10.0	* 24				
Max Q Clear Time (g_c+I1), s		14.8	19.0	13.9		8.1	3.4	12.8				
Green Ext Time (p_c), s		0.5	0.0	0.5		0.1	0.0	1.9				

### Intersection Summary

HCM 6th Ctrl Delay	36.8
HCM 6th LOS	D

### Notes

- User approved pedestrian interval to be less than phase max green.
- User approved volume balancing among the lanes for turning movement.
- \* HCM 6th computational engine requires equal clearance times for the phases crossing the barrier.

HCM 6th AWSC  
 15: Arnold Dr & Warm Springs Rd/Private Dwy

Existing plus Project Conditions PM

Intersection

Intersection Delay, s/veh 11.2

Intersection LOS B

Movement	EBL	EBT	EBR	WBL	WBT	WBR	NBL	NBT	NBR	SBL	SBT	SBR
Lane Configurations		↕			↕			↕			↕	
Traffic Vol, veh/h	50	10	192	10	10	10	132	152	10	10	122	60
Future Vol, veh/h	50	10	192	10	10	10	132	152	10	10	122	60
Peak Hour Factor	0.92	0.92	0.92	0.92	0.92	0.92	0.92	0.92	0.92	0.92	0.92	0.92
Heavy Vehicles, %	2	2	2	2	2	2	2	2	2	2	2	2
Mvmt Flow	54	11	209	11	11	11	143	165	11	11	133	65
Number of Lanes	0	1	0	0	1	0	0	1	0	0	1	0

Approach	EB	WB	NB	SB
Opposing Approach	WB	EB	SB	NB
Opposing Lanes	1	1	1	1
Conflicting Approach Left SB		NB	EB	WB
Conflicting Lanes Left	1	1	1	1
Conflicting Approach Right NB		SB	WB	EB
Conflicting Lanes Right	1	1	1	1
HCM Control Delay	10.9	9	12.3	10.1
HCM LOS	B	A	B	B

Lane	NBLn1	EBLn1	WBLn1	SBLn1
Vol Left, %	45%	20%	33%	5%
Vol Thru, %	52%	4%	33%	64%
Vol Right, %	3%	76%	33%	31%
Sign Control	Stop	Stop	Stop	Stop
Traffic Vol by Lane	294	252	30	192
LT Vol	132	50	10	10
Through Vol	152	10	10	122
RT Vol	10	192	10	60
Lane Flow Rate	320	274	33	209
Geometry Grp	1	1	1	1
Degree of Util (X)	0.454	0.375	0.051	0.291
Departure Headway (Hd)	5.111	4.93	5.609	5.019
Convergence, Y/N	Yes	Yes	Yes	Yes
Cap	706	731	638	716
Service Time	3.128	2.946	3.65	3.048
HCM Lane V/C Ratio	0.453	0.375	0.052	0.292
HCM Control Delay	12.3	10.9	9	10.1
HCM Lane LOS	B	B	A	B
HCM 95th-tile Q	2.4	1.7	0.2	1.2

HCM 6th TWSC  
16: Riverside Dr & Verano Ave

Existing plus Project Conditions PM

Intersection												
Int Delay, s/veh	53.1											
Movement	EBL	EBT	EBR	WBL	WBT	WBR	NBL	NBT	NBR	SBL	SBT	SBR
Lane Configurations	↔	↔			↔			↔			↔	
Traffic Vol, veh/h	55	325	110	70	375	140	20	80	20	75	50	35
Future Vol, veh/h	55	325	110	70	375	140	20	80	20	75	50	35
Conflicting Peds, #/hr	0	0	0	0	0	0	0	0	0	0	0	0
Sign Control	Free	Free	Free	Free	Free	Free	Stop	Stop	Stop	Stop	Stop	Stop
RT Channelized	-	-	None	-	-	None	-	-	None	-	-	None
Storage Length	100	-	-	-	-	-	-	-	-	-	-	-
Veh in Median Storage, #	-	0	-	-	0	-	-	0	-	-	0	-
Grade, %	-	0	-	-	0	-	-	0	-	-	0	-
Peak Hour Factor	92	92	92	92	92	92	92	92	92	92	92	92
Heavy Vehicles, %	2	2	2	2	2	2	2	2	2	2	2	2
Mvmt Flow	60	353	120	76	408	152	22	87	22	82	54	38

Major/Minor	Major1			Major2			Minor1			Minor2		
Conflicting Flow All	560	0	0	473	0	0	1215	1245	413	1224	1229	484
Stage 1	-	-	-	-	-	-	533	533	-	636	636	-
Stage 2	-	-	-	-	-	-	682	712	-	588	593	-
Critical Hdwy	4.12	-	-	4.12	-	-	7.12	6.52	6.22	7.12	6.52	6.22
Critical Hdwy Stg 1	-	-	-	-	-	-	6.12	5.52	-	6.12	5.52	-
Critical Hdwy Stg 2	-	-	-	-	-	-	6.12	5.52	-	6.12	5.52	-
Follow-up Hdwy	2.218	-	-	2.218	-	-	3.518	4.018	3.318	3.518	4.018	3.318
Pot Cap-1 Maneuver	1011	-	-	1089	-	-	158	174	639	156	178	583
Stage 1	-	-	-	-	-	-	531	525	-	466	472	-
Stage 2	-	-	-	-	-	-	440	436	-	495	493	-
Platoon blocked, %		-	-		-	-						
Mov Cap-1 Maneuver	1011	-	-	1089	-	-	94	147	639	~ 71	150	583
Mov Cap-2 Maneuver	-	-	-	-	-	-	94	147	-	~ 71	150	-
Stage 1	-	-	-	-	-	-	500	494	-	439	423	-
Stage 2	-	-	-	-	-	-	321	391	-	371	464	-

Approach	EB			WB			NB			SB		
HCM Control Delay, s	1			1			97.6			\$ 369.4		
HCM LOS							F			F		

Minor Lane/Major Mvmt	NBLn1	EBL	EBT	EBR	WBL	WBT	WBR	SBLn1
Capacity (veh/h)	152	1011	-	-	1089	-	-	110
HCM Lane V/C Ratio	0.858	0.059	-	-	0.07	-	-	1.581
HCM Control Delay (s)	97.6	8.8	-	-	8.6	0	-	\$ 369.4
HCM Lane LOS	F	A	-	-	A	A	-	F
HCM 95th %tile Q(veh)	5.8	0.2	-	-	0.2	-	-	13

Notes  
 -: Volume exceeds capacity    \$: Delay exceeds 300s    +: Computation Not Defined    \*: All major volume in platoon

HCM 6th Signalized Intersection Summary  
 17: Main St/Petaluma Hill Rd & Old Adobe Rd/Adobe Rd

Existing plus Project Conditions PM



Movement	EBL	EBT	EBR	WBL	WBT	WBR	NBL	NBT	NBR	SBL	SBT	SBR
Lane Configurations		↕			↕			↕		↕	↕	↕
Traffic Volume (veh/h)	31	131	50	20	185	390	40	635	20	260	286	34
Future Volume (veh/h)	31	131	50	20	185	390	40	635	20	260	286	34
Initial Q (Qb), veh	0	0	0	0	0	0	0	0	0	0	0	0
Ped-Bike Adj(A_pbT)	1.00		0.99	1.00		0.99	1.00		1.00	1.00		0.99
Parking Bus, Adj	1.00	1.00	1.00	1.00	1.00	1.00	1.00	1.00	1.00	1.00	1.00	1.00
Work Zone On Approach		No			No			No			No	
Adj Sat Flow, veh/h/ln	1870	1870	1870	1870	1870	1870	1870	1870	1870	1870	1870	1870
Adj Flow Rate, veh/h	34	142	39	22	201	331	43	690	20	283	311	30
Peak Hour Factor	0.92	0.92	0.92	0.92	0.92	0.92	0.92	0.92	0.92	0.92	0.92	0.92
Percent Heavy Veh, %	2	2	2	2	2	2	2	2	2	2	2	2
Cap, veh/h	104	391	97	61	227	354	27	433	13	327	308	30
Arrive On Green	0.36	0.36	0.36	0.36	0.36	0.36	0.25	0.25	0.25	0.18	0.18	0.18
Sat Flow, veh/h	135	1098	273	32	639	995	106	1701	49	1781	1677	162
Grp Volume(v), veh/h	215	0	0	554	0	0	753	0	0	283	0	341
Grp Sat Flow(s),veh/h/ln	1507	0	0	1665	0	0	1856	0	0	1781	0	1839
Q Serve(g_s), s	0.0	0.0	0.0	10.2	0.0	0.0	19.0	0.0	0.0	11.5	0.0	13.7
Cycle Q Clear(g_c), s	6.5	0.0	0.0	23.9	0.0	0.0	19.0	0.0	0.0	11.5	0.0	13.7
Prop In Lane	0.16		0.18	0.04		0.60	0.06		0.03	1.00		0.09
Lane Grp Cap(c), veh/h	592	0	0	642	0	0	472	0	0	327	0	337
V/C Ratio(X)	0.36	0.00	0.00	0.86	0.00	0.00	1.59	0.00	0.00	0.87	0.00	1.01
Avail Cap(c_a), veh/h	592	0	0	690	0	0	472	0	0	327	0	337
HCM Platoon Ratio	1.00	1.00	1.00	1.00	1.00	1.00	1.00	1.00	1.00	1.00	1.00	1.00
Upstream Filter(I)	1.00	0.00	0.00	1.00	0.00	0.00	1.00	0.00	0.00	1.00	0.00	1.00
Uniform Delay (d), s/veh	17.6	0.0	0.0	23.2	0.0	0.0	27.8	0.0	0.0	29.6	0.0	30.5
Incr Delay (d2), s/veh	0.1	0.0	0.0	9.7	0.0	0.0	277.2	0.0	0.0	20.1	0.0	51.7
Initial Q Delay(d3),s/veh	0.0	0.0	0.0	0.0	0.0	0.0	0.0	0.0	0.0	0.0	0.0	0.0
%ile BackOfQ(50%),veh/ln	2.5	0.0	0.0	10.0	0.0	0.0	44.5	0.0	0.0	6.5	0.0	10.6
Unsig. Movement Delay, s/veh												
LnGrp Delay(d),s/veh	17.7	0.0	0.0	32.8	0.0	0.0	305.0	0.0	0.0	49.7	0.0	82.2
LnGrp LOS	B	A	A	C	A	A	F	A	A	D	A	F
Approach Vol, veh/h		215			554			753				624
Approach Delay, s/veh		17.7			32.8			305.0				67.4
Approach LOS		B			C			F				E
Timer - Assigned Phs		2		4		6		8				
Phs Duration (G+Y+Rc), s		23.6		32.0		19.1		32.0				
Change Period (Y+Rc), s		4.6		* 5.4		5.4		5.4				
Max Green Setting (Gmax), s		19.0		* 24		13.7		28.7				
Max Q Clear Time (g_c+I1), s		21.0		8.5		15.7		25.9				
Green Ext Time (p_c), s		0.0		0.4		0.0		0.5				

Intersection Summary

HCM 6th Ctrl Delay	136.9
HCM 6th LOS	F

Notes

- User approved pedestrian interval to be less than phase max green.
- \* HCM 6th computational engine requires equal clearance times for the phases crossing the barrier.

# HCM 6th Signalized Intersection Summary

## 18: Old Redwood Hwy & Main St

Existing plus Project Conditions PM



Movement	WBL	WBR	NBT	NBR	SBL	SBT
Lane Configurations						
Traffic Volume (veh/h)	333	22	535	682	22	250
Future Volume (veh/h)	333	22	535	682	22	250
Initial Q (Qb), veh	0	0	0	0	0	0
Ped-Bike Adj(A_pbT)	1.00	1.00		1.00	1.00	
Parking Bus, Adj	1.00	1.00	1.00	1.00	1.00	1.00
Work Zone On Approach	No		No		No	
Adj Sat Flow, veh/h/ln	1870	1870	1870	1870	1870	1870
Adj Flow Rate, veh/h	362	6	582	741	24	272
Peak Hour Factor	0.92	0.92	0.92	0.92	0.92	0.92
Percent Heavy Veh, %	2	2	2	2	2	2
Cap, veh/h	410	365	893	757	39	1118
Arrive On Green	0.23	0.23	0.48	0.48	0.02	0.60
Sat Flow, veh/h	1781	1585	1870	1585	1781	1870
Grp Volume(v), veh/h	362	6	582	741	24	272
Grp Sat Flow(s),veh/h/ln	1781	1585	1870	1585	1781	1870
Q Serve(g_s), s	12.3	0.2	14.8	28.8	0.8	4.3
Cycle Q Clear(g_c), s	12.3	0.2	14.8	28.8	0.8	4.3
Prop In Lane	1.00	1.00		1.00	1.00	
Lane Grp Cap(c), veh/h	410	365	893	757	39	1118
V/C Ratio(X)	0.88	0.02	0.65	0.98	0.62	0.24
Avail Cap(c_a), veh/h	850	757	893	757	340	1118
HCM Platoon Ratio	1.00	1.00	1.00	1.00	1.00	1.00
Upstream Filter(I)	1.00	1.00	1.00	1.00	1.00	1.00
Uniform Delay (d), s/veh	23.4	18.7	12.5	16.1	30.5	5.9
Incr Delay (d2), s/veh	2.5	0.0	1.3	27.4	5.8	0.0
Initial Q Delay(d3),s/veh	0.0	0.0	0.0	0.0	0.0	0.0
%ile BackOfQ(50%),veh/ln	5.2	0.1	5.2	13.8	0.4	1.2
Unsig. Movement Delay, s/veh						
LnGrp Delay(d),s/veh	25.9	18.7	13.8	43.6	36.3	6.0
LnGrp LOS	C	B	B	D	D	A
Approach Vol, veh/h	368		1323			296
Approach Delay, s/veh	25.8		30.5			8.4
Approach LOS	C		C			A
Timer - Assigned Phs	1	2		4		6
Phs Duration (G+Y+Rc), s	7.6	36.2		19.1		43.8
Change Period (Y+Rc), s	6.2	6.2		4.6		6.2
Max Green Setting (Gmax)	30.0	30.0		30.0		30.0
Max Q Clear Time (g_c+1)	12.8	30.8		14.3		6.3
Green Ext Time (p_c), s	0.0	0.0		0.2		0.4

### Intersection Summary

HCM 6th Ctrl Delay	26.3
HCM 6th LOS	C

### Notes

User approved pedestrian interval to be less than phase max green.

HCM 6th TWSC  
 19: Private Dwy/Paula Ln & Bodega Ave

Existing plus Project Conditions PM

Intersection												
Int Delay, s/veh	2.1											
Movement	EBL	EBT	EBR	WBL	WBT	WBR	NBL	NBT	NBR	SBL	SBT	SBR
Lane Configurations	↶	↷		↶	↷			↕			↕	
Traffic Vol, veh/h	20	355	5	25	425	20	5	5	20	25	10	20
Future Vol, veh/h	20	355	5	25	425	20	5	5	20	25	10	20
Conflicting Peds, #/hr	0	0	0	0	0	0	0	0	0	0	0	0
Sign Control	Free	Free	Free	Free	Free	Free	Stop	Stop	Stop	Stop	Stop	Stop
RT Channelized	-	-	None	-	-	None	-	-	None	-	-	None
Storage Length	90	-	-	90	-	-	-	-	-	-	-	-
Veh in Median Storage, #	-	0	-	-	0	-	-	0	-	-	0	-
Grade, %	-	0	-	-	0	-	-	0	-	-	0	-
Peak Hour Factor	92	92	92	92	92	92	92	92	92	92	92	92
Heavy Vehicles, %	2	2	2	2	2	2	2	2	2	2	2	2
Mvmt Flow	22	386	5	27	462	22	5	5	22	27	11	22

Major/Minor	Major1			Major2			Minor1			Minor2		
Conflicting Flow All	484	0	0	391	0	0	977	971	389	973	962	473
Stage 1	-	-	-	-	-	-	433	433	-	527	527	-
Stage 2	-	-	-	-	-	-	544	538	-	446	435	-
Critical Hdwy	4.12	-	-	4.12	-	-	7.12	6.52	6.22	7.12	6.52	6.22
Critical Hdwy Stg 1	-	-	-	-	-	-	6.12	5.52	-	6.12	5.52	-
Critical Hdwy Stg 2	-	-	-	-	-	-	6.12	5.52	-	6.12	5.52	-
Follow-up Hdwy	2.218	-	-	2.218	-	-	3.518	4.018	3.318	3.518	4.018	3.318
Pot Cap-1 Maneuver	1079	-	-	1168	-	-	230	253	659	231	256	591
Stage 1	-	-	-	-	-	-	601	582	-	535	528	-
Stage 2	-	-	-	-	-	-	523	522	-	591	580	-
Platoon blocked, %	-	-	-	-	-	-	-	-	-	-	-	-
Mov Cap-1 Maneuver	1079	-	-	1168	-	-	207	242	659	212	245	591
Mov Cap-2 Maneuver	-	-	-	-	-	-	207	242	-	212	245	-
Stage 1	-	-	-	-	-	-	589	570	-	524	516	-
Stage 2	-	-	-	-	-	-	482	510	-	555	568	-























Approach	EB			WB			NB			SB		
HCM Control Delay, s	0.4			0.4			14.8			20.9		
HCM LOS							B			C		

Minor Lane/Major Mvmt	NBLn1	EBL	EBT	EBR	WBL	WBT	WBR	SBLn1
Capacity (veh/h)	399	1079	-	-	1168	-	-	286
HCM Lane V/C Ratio	0.082	0.02	-	-	0.023	-	-	0.209
HCM Control Delay (s)	14.8	8.4	-	-	8.2	-	-	20.9
HCM Lane LOS	B	A	-	-	A	-	-	C
HCM 95th %tile Q(veh)	0.3	0.1	-	-	0.1	-	-	0.8



HCM 6th Signalized Intersection Summary  
 20: Broadway & Leveroni Rd/Napa Rd

Existing plus Project Conditions PM

												
Movement	EBL	EBT	EBR	WBL	WBT	WBR	NBL	NBT	NBR	SBL	SBT	SBR
Lane Configurations												
Traffic Volume (veh/h)	110	350	63	73	380	240	72	255	102	240	270	110
Future Volume (veh/h)	110	350	63	73	380	240	72	255	102	240	270	110
Initial Q (Qb), veh	0	0	0	0	0	0	0	0	0	0	0	0
Ped-Bike Adj(A_pbT)	1.00		1.00	1.00		1.00	1.00		0.98	1.00		0.99
Parking Bus, Adj	1.00	1.00	1.00	1.00	1.00	1.00	1.00	1.00	1.00	1.00	1.00	1.00
Work Zone On Approach		No			No			No			No	
Adj Sat Flow, veh/h/ln	1870	1870	1870	1870	1870	1870	1870	1870	1870	1870	1870	1870
Adj Flow Rate, veh/h	120	380	64	79	413	244	78	277	71	261	293	81
Peak Hour Factor	0.92	0.92	0.92	0.92	0.92	0.92	0.92	0.92	0.92	0.92	0.92	0.92
Percent Heavy Veh, %	2	2	2	2	2	2	2	2	2	2	2	2
Cap, veh/h	215	582	98	194	398	235	193	420	105	298	576	156
Arrive On Green	0.12	0.37	0.37	0.11	0.36	0.36	0.11	0.15	0.15	0.17	0.21	0.21
Sat Flow, veh/h	1781	1559	263	1781	1100	650	1781	2802	704	1781	2755	747
Grp Volume(v), veh/h	120	0	444	79	0	657	78	174	174	261	187	187
Grp Sat Flow(s),veh/h/ln	1781	0	1822	1781	0	1750	1781	1777	1730	1781	1777	1725
Q Serve(g_s), s	5.4	0.0	17.3	3.5	0.0	31.0	3.5	7.9	8.2	12.3	8.0	8.3
Cycle Q Clear(g_c), s	5.4	0.0	17.3	3.5	0.0	31.0	3.5	7.9	8.2	12.3	8.0	8.3
Prop In Lane	1.00		0.14	1.00		0.37	1.00		0.41	1.00		0.43
Lane Grp Cap(c), veh/h	215	0	680	194	0	632	193	266	259	298	372	361
V/C Ratio(X)	0.56	0.00	0.65	0.41	0.00	1.04	0.40	0.65	0.67	0.87	0.50	0.52
Avail Cap(c_a), veh/h	540	0	680	540	0	632	228	559	544	332	559	543
HCM Platoon Ratio	1.00	1.00	1.00	1.00	1.00	1.00	1.00	1.00	1.00	1.00	1.00	1.00
Upstream Filter(I)	1.00	0.00	1.00	1.00	0.00	1.00	1.00	1.00	1.00	1.00	1.00	1.00
Uniform Delay (d), s/veh	35.5	0.0	22.3	35.7	0.0	27.4	35.7	34.4	34.5	34.8	30.0	30.1
Incr Delay (d2), s/veh	2.2	0.0	2.2	1.4	0.0	46.3	1.4	2.7	3.0	20.5	1.1	1.2
Initial Q Delay(d3),s/veh	0.0	0.0	0.0	0.0	0.0	0.0	0.0	0.0	0.0	0.0	0.0	0.0
%ile BackOfQ(50%),veh/ln	2.4	0.0	7.1	1.6	0.0	19.9	1.5	3.4	3.5	6.8	3.4	3.4
Unsig. Movement Delay, s/veh												
LnGrp Delay(d),s/veh	37.8	0.0	24.5	37.0	0.0	73.7	37.0	37.1	37.5	55.3	31.0	31.3
LnGrp LOS	D	A	C	D	A	F	D	D	D	E	C	C
Approach Vol, veh/h		564			736			426			635	
Approach Delay, s/veh		27.3			69.7			37.2			41.1	
Approach LOS		C			E			D			D	
Timer - Assigned Phs	1	2	3	4	5	6	7	8				
Phs Duration (G+Y+Rc), s	13.3	22.9	14.4	35.2	18.4	17.9	13.3	36.2				
Change Period (Y+Rc), s	4.0	5.0	4.0	* 4.2	4.0	5.0	4.0	* 4.2				
Max Green Setting (Gmax), s	11.0	27.0	26.0	* 31	16.0	27.0	26.0	* 31				
Max Q Clear Time (g_c+I1), s	5.5	10.3	7.4	33.0	14.3	10.2	5.5	19.3				
Green Ext Time (p_c), s	0.1	1.9	0.3	0.0	0.1	1.6	0.2	1.9				

Intersection Summary

HCM 6th Ctrl Delay	46.0
HCM 6th LOS	D

Notes

\* HCM 6th computational engine requires equal clearance times for the phases crossing the barrier.

**ATTACHMENT C-3**

**CUMULATIVE (YEAR 2040) CONDITIONS OUPUTS**



HCM 6th AWSC  
 1: Geyserville Ave & Canyon Road

Cumulative Conditions AM

Intersection	
Intersection Delay, s/veh	9.2
Intersection LOS	A

Movement	EBL	EBT	EBR	WBL	WBT	WBR	NBL	NBT	NBR	SBL	SBT	SBR
Lane Configurations		↔			↔			↔			↔	
Traffic Vol, veh/h	50	20	210	20	20	20	110	30	20	20	30	30
Future Vol, veh/h	50	20	210	20	20	20	110	30	20	20	30	30
Peak Hour Factor	0.95	0.95	0.95	0.95	0.95	0.95	0.95	0.95	0.95	0.95	0.95	0.95
Heavy Vehicles, %	2	2	2	2	2	2	2	2	2	2	2	2
Mvmt Flow	53	21	221	21	21	21	116	32	21	21	32	32
Number of Lanes	0	1	0	0	1	0	0	1	0	0	1	0

Approach	EB	WB	NB	SB
Opposing Approach	WB	EB	SB	NB
Opposing Lanes	1	1	1	1
Conflicting Approach Left	SB	NB	EB	WB
Conflicting Lanes Left	1	1	1	1
Conflicting Approach Right	NB	SB	WB	EB
Conflicting Lanes Right	1	1	1	1
HCM Control Delay	9.5	8.2	9.4	8.4
HCM LOS	A	A	A	A

Lane	NBLn1	EBLn1	WBLn1	SBLn1
Vol Left, %	69%	18%	33%	25%
Vol Thru, %	19%	7%	33%	38%
Vol Right, %	12%	75%	33%	38%
Sign Control	Stop	Stop	Stop	Stop
Traffic Vol by Lane	160	280	60	80
LT Vol	110	50	20	20
Through Vol	30	20	20	30
RT Vol	20	210	20	30
Lane Flow Rate	168	295	63	84
Geometry Grp	1	1	1	1
Degree of Util (X)	0.229	0.345	0.083	0.111
Departure Headway (Hd)	4.887	4.217	4.748	4.764
Convergence, Y/N	Yes	Yes	Yes	Yes
Cap	733	852	752	749
Service Time	2.933	2.249	2.795	2.816
HCM Lane V/C Ratio	0.229	0.346	0.084	0.112
HCM Control Delay	9.4	9.5	8.2	8.4
HCM Lane LOS	A	A	A	A
HCM 95th-tile Q	0.9	1.5	0.3	0.4

# HCM 6th Signalized Intersection Summary

## 2: Armstrong Woods Rd & River Rd

Cumulative Conditions AM



Movement	EBL	EBT	EBR	WBL	WBT	WBR	NBL	NBT	NBR	SBL	SBT	SBR
Lane Configurations												
Traffic Volume (veh/h)	90	520	0	0	540	140	20	40	40	160	0	40
Future Volume (veh/h)	90	520	0	0	540	140	20	40	40	160	0	40
Initial Q (Qb), veh	0	0	0	0	0	0	0	0	0	0	0	0
Ped-Bike Adj(A_pbT)	1.00		1.00	1.00		0.99	0.99		0.99	0.99		0.99
Parking Bus, Adj	1.00	1.00	1.00	1.00	1.00	1.00	1.00	1.00	1.00	1.00	1.00	1.00
Work Zone On Approach	No				No				No			
Adj Sat Flow, veh/h/ln	1870	1870	0	0	1870	1870	1870	1870	1870	1870	1870	1870
Adj Flow Rate, veh/h	95	547	0	0	568	80	21	42	7	168	0	7
Peak Hour Factor	0.95	0.95	0.95	0.95	0.95	0.95	0.95	0.95	0.95	0.95	0.95	0.95
Percent Heavy Veh, %	2	2	0	0	2	2	2	2	2	2	2	2
Cap, veh/h	451	1136	0	0	754	635	418	304	51	383	0	305
Arrive On Green	0.11	0.61	0.00	0.00	0.40	0.40	0.20	0.20	0.20	0.20	0.00	0.20
Sat Flow, veh/h	1781	1870	0	0	1870	1575	1391	1560	260	1341	0	1565
Grp Volume(v), veh/h	95	547	0	0	568	80	21	0	49	168	0	7
Grp Sat Flow(s),veh/h/ln	1781	1870	0	0	1870	1575	1391	0	1820	1341	0	1565
Q Serve(g_s), s	1.2	7.7	0.0	0.0	12.4	1.5	0.6	0.0	1.1	5.6	0.0	0.2
Cycle Q Clear(g_c), s	1.2	7.7	0.0	0.0	12.4	1.5	0.8	0.0	1.1	6.7	0.0	0.2
Prop In Lane	1.00		0.00	0.00		1.00	1.00		0.14	1.00		1.00
Lane Grp Cap(c), veh/h	451	1136	0	0	754	635	418	0	355	383	0	305
V/C Ratio(X)	0.21	0.48	0.00	0.00	0.75	0.13	0.05	0.00	0.14	0.44	0.00	0.02
Avail Cap(c_a), veh/h	525	1258	0	0	1651	1390	672	0	688	629	0	592
HCM Platoon Ratio	1.00	1.00	1.00	1.00	1.00	1.00	1.00	1.00	1.00	1.00	1.00	1.00
Upstream Filter(I)	1.00	1.00	0.00	0.00	1.00	1.00	1.00	0.00	1.00	1.00	0.00	1.00
Uniform Delay (d), s/veh	7.6	5.2	0.0	0.0	12.2	8.9	15.8	0.0	15.8	18.6	0.0	15.5
Incr Delay (d2), s/veh	0.2	0.3	0.0	0.0	1.5	0.1	0.0	0.0	0.2	0.8	0.0	0.0
Initial Q Delay(d3),s/veh	0.0	0.0	0.0	0.0	0.0	0.0	0.0	0.0	0.0	0.0	0.0	0.0
%ile BackOfQ(50%),veh/ln	0.4	2.0	0.0	0.0	4.6	0.5	0.2	0.0	0.4	1.7	0.0	0.1
Unsig. Movement Delay, s/veh												
LnGrp Delay(d),s/veh	7.8	5.5	0.0	0.0	13.7	9.0	15.8	0.0	16.0	19.4	0.0	15.5
LnGrp LOS	A	A	A	A	B	A	B	A	B	B	A	B
Approach Vol, veh/h	642				648				70		175	
Approach Delay, s/veh	5.8				13.1				16.0		19.2	
Approach LOS	A				B				B		B	
Timer - Assigned Phs	2		4		5		6		8			
Phs Duration (G+Y+Rc), s	33.6		14.0		9.7		23.9		14.0			
Change Period (Y+Rc), s	* 4.7		* 4.7		* 4.7		* 4.7		* 4.7			
Max Green Setting (Gmax), s	* 32		* 18		* 7		* 42		* 18			
Max Q Clear Time (g_c+1), s	9.7		8.7		3.2		14.4		3.1			
Green Ext Time (p_c), s	3.9		0.3		0.1		4.6		0.2			

### Intersection Summary

HCM 6th Ctrl Delay	10.9
HCM 6th LOS	B

### Notes

- User approved pedestrian interval to be less than phase max green.
- \* HCM 6th computational engine requires equal clearance times for the phases crossing the barrier.

# HCM 6th Signalized Intersection Summary

## 3: Gravenstein Hwy/Old River Rd & River Rd

Cumulative Conditions AM



Movement	EBL	EBT	EBR	WBL	WBT	WBR	NBL	NBT	NBR	SBL	SBT	SBR
Lane Configurations		↑	↗	↖	↗	↖	↗	↖			↕	
Traffic Volume (veh/h)	0	510	210	40	490	20	170	50	120	20	40	20
Future Volume (veh/h)	0	510	210	40	490	20	170	50	120	20	40	20
Initial Q (Qb), veh	0	0	0	0	0	0	0	0	0	0	0	0
Ped-Bike Adj(A_pbT)	1.00		0.99	1.00		1.00	0.99		1.00	1.00		0.99
Parking Bus, Adj	1.00	1.00	1.00	1.00	1.00	1.00	1.00	1.00	1.00	1.00	1.00	1.00
Work Zone On Approach		No		No		No		No		No		No
Adj Sat Flow, veh/h/ln	0	1870	1870	1870	1870	1870	1870	1870	1870	1870	1870	1870
Adj Flow Rate, veh/h	0	537	163	42	516	19	179	53	27	21	42	4
Peak Hour Factor	0.95	0.95	0.95	0.95	0.95	0.95	0.95	0.95	0.95	0.95	0.95	0.95
Percent Heavy Veh, %	0	2	2	2	2	2	2	2	2	2	2	2
Cap, veh/h	0	708	596	412	1025	38	461	243	124	175	272	21
Arrive On Green	0.00	0.38	0.38	0.08	0.57	0.57	0.21	0.21	0.21	0.21	0.21	0.21
Sat Flow, veh/h	0	1870	1575	1781	1792	66	1346	1168	595	307	1312	103
Grp Volume(v), veh/h	0	537	163	42	0	535	179	0	80	67	0	0
Grp Sat Flow(s),veh/h/ln	0	1870	1575	1781	0	1858	1346	0	1763	1722	0	0
Q Serve(g_s), s	0.0	10.7	3.1	0.5	0.0	7.4	3.5	0.0	1.6	0.0	0.0	0.0
Cycle Q Clear(g_c), s	0.0	10.7	3.1	0.5	0.0	7.4	4.7	0.0	1.6	1.3	0.0	0.0
Prop In Lane	0.00		1.00	1.00		0.04	1.00		0.34	0.31		0.06
Lane Grp Cap(c), veh/h	0	708	596	412	0	1062	461	0	366	468	0	0
V/C Ratio(X)	0.00	0.76	0.27	0.10	0.00	0.50	0.39	0.00	0.22	0.14	0.00	0.00
Avail Cap(c_a), veh/h	0	1054	887	641	0	1062	1129	0	1242	513	0	0
HCM Platoon Ratio	1.00	1.00	1.00	1.00	1.00	1.00	1.00	1.00	1.00	1.00	1.00	1.00
Upstream Filter(I)	0.00	1.00	1.00	1.00	0.00	1.00	1.00	0.00	1.00	1.00	0.00	0.00
Uniform Delay (d), s/veh	0.0	11.5	9.2	7.3	0.0	5.5	15.1	0.0	14.0	13.9	0.0	0.0
Incr Delay (d2), s/veh	0.0	1.8	0.2	0.1	0.0	0.4	0.5	0.0	0.3	0.1	0.0	0.0
Initial Q Delay(d3),s/veh	0.0	0.0	0.0	0.0	0.0	0.0	0.0	0.0	0.0	0.0	0.0	0.0
%ile BackOfQ(50%),veh/ln	0.0	3.9	0.9	0.1	0.0	1.9	1.4	0.0	0.6	0.5	0.0	0.0
Unsig. Movement Delay, s/veh												
LnGrp Delay(d),s/veh	0.0	13.3	9.4	7.4	0.0	5.9	15.7	0.0	14.3	14.0	0.0	0.0
LnGrp LOS	A	B	A	A	A	A	B	A	B	B	A	A
Approach Vol, veh/h		700			577			259			67	
Approach Delay, s/veh		12.4			6.0			15.2			14.0	
Approach LOS		B			A			B			B	
Timer - Assigned Phs	1	2		4		6		8				
Phs Duration (G+Y+Rc), s	20.8			13.5		29.1		13.5				
Change Period (Y+Rc), s	* 4.7			* 4.7		* 4.7		* 4.7				
Max Green Setting (Gmax), s	* 24			* 10		* 24		* 30				
Max Q Clear Time (g_c+1/2), s	12.7			3.3		9.4		6.7				
Green Ext Time (p_c), s	0.0	3.3		0.1		3.2		1.0				

### Intersection Summary

HCM 6th Ctrl Delay	10.6
HCM 6th LOS	B

### Notes

- User approved pedestrian interval to be less than phase max green.
- \* HCM 6th computational engine requires equal clearance times for the phases crossing the barrier.

HCM 6th TWSC  
 4: Old Redwood Hwy & Fulton Rd

Cumulative Conditions AM

Intersection						
Int Delay, s/veh	12.7					
Movement	EBL	EBR	NBL	NBT	SBT	SBR
Lane Configurations						
Traffic Vol, veh/h	180	40	40	190	860	400
Future Vol, veh/h	180	40	40	190	860	400
Conflicting Peds, #/hr	0	0	0	0	0	0
Sign Control	Stop	Stop	Free	Free	Free	Free
RT Channelized	-	Stop	-	None	-	None
Storage Length	0	90	70	-	-	100
Veh in Median Storage, #	0	-	-	0	0	-
Grade, %	0	-	-	0	0	-
Peak Hour Factor	95	95	95	95	95	95
Heavy Vehicles, %	2	2	2	2	2	2
Mvmt Flow	189	42	42	200	905	421

Major/Minor	Minor2	Major1	Major2			
Conflicting Flow All	1189	905	1326	0	-	0
Stage 1	905	-	-	-	-	-
Stage 2	284	-	-	-	-	-
Critical Hdwy	6.42	6.22	4.12	-	-	-
Critical Hdwy Stg 1	5.42	-	-	-	-	-
Critical Hdwy Stg 2	5.42	-	-	-	-	-
Follow-up Hdwy	3.518	3.318	2.218	-	-	-
Pot Cap-1 Maneuver	208	335	521	-	-	-
Stage 1	395	-	-	-	-	-
Stage 2	764	-	-	-	-	-
Platoon blocked, %				-	-	-
Mov Cap-1 Maneuver	191	335	521	-	-	-
Mov Cap-2 Maneuver	191	-	-	-	-	-
Stage 1	363	-	-	-	-	-
Stage 2	764	-	-	-	-	-























Approach	EB	NB	SB
HCM Control Delay, s	96.3	2.2	0
HCM LOS	F		

Minor Lane/Major Mvmt	NBL	NBT	EBLn1	EBLn2	SBT	SBR
Capacity (veh/h)	521	-	191	335	-	-
HCM Lane V/C Ratio	0.081	-	0.992	0.126	-	-
HCM Control Delay (s)	12.5	-	113.8	17.3	-	-
HCM Lane LOS	B	-	F	C	-	-
HCM 95th %tile Q(veh)	0.3	-	8.3	0.4	-	-

# HCM 6th Signalized Intersection Summary

## 5: Fulton Rd & Airport Blvd

Cumulative Conditions AM

												
Movement	EBL	EBT	EBR	WBL	WBT	WBR	NBL	NBT	NBR	SBL	SBT	SBR
Lane Configurations												
Traffic Volume (veh/h)	80	340	210	230	610	30	720	180	160	40	280	260
Future Volume (veh/h)	80	340	210	230	610	30	720	180	160	40	280	260
Initial Q (Qb), veh	0	0	0	0	0	0	0	0	0	0	0	0
Ped-Bike Adj(A_pbT)	1.00		0.99	1.00		0.99	1.00		0.99	1.00		0.99
Parking Bus, Adj	1.00	1.00	1.00	1.00	1.00	1.00	1.00	1.00	1.00	1.00	1.00	1.00
Work Zone On Approach		No			No			No			No	
Adj Sat Flow, veh/h/ln	1870	1870	1870	1870	1870	1870	1870	1870	1870	1870	1870	1870
Adj Flow Rate, veh/h	84	358	41	242	642	31	758	189	35	42	295	249
Peak Hour Factor	0.95	0.95	0.95	0.95	0.95	0.95	0.95	0.95	0.95	0.95	0.95	0.95
Percent Heavy Veh, %	2	2	2	2	2	2	2	2	2	2	2	2
Cap, veh/h	107	406	340	270	540	26	467	490	411	22	152	128
Arrive On Green	0.06	0.22	0.22	0.15	0.31	0.31	0.26	0.26	0.26	0.17	0.17	0.17
Sat Flow, veh/h	1781	1870	1567	1781	1769	85	1781	1870	1570	124	868	733
Grp Volume(v), veh/h	84	358	41	242	0	673	758	189	35	586	0	0
Grp Sat Flow(s),veh/h/ln	1781	1870	1567	1781	0	1854	1781	1870	1570	1725	0	0
Q Serve(g_s), s	5.3	21.2	2.4	15.3	0.0	35.0	30.0	9.5	1.9	20.0	0.0	0.0
Cycle Q Clear(g_c), s	5.3	21.2	2.4	15.3	0.0	35.0	30.0	9.5	1.9	20.0	0.0	0.0
Prop In Lane	1.00		1.00	1.00		0.05	1.00		1.00	0.07		0.42
Lane Grp Cap(c), veh/h	107	406	340	270	0	566	467	490	411	301	0	0
V/C Ratio(X)	0.79	0.88	0.12	0.90	0.00	1.19	1.62	0.39	0.09	1.95	0.00	0.00
Avail Cap(c_a), veh/h	311	490	410	311	0	566	467	490	411	301	0	0
HCM Platoon Ratio	1.00	1.00	1.00	1.00	1.00	1.00	1.00	1.00	1.00	1.00	1.00	1.00
Upstream Filter(I)	1.00	1.00	1.00	1.00	0.00	1.00	1.00	1.00	1.00	1.00	0.00	0.00
Uniform Delay (d), s/veh	53.1	43.4	36.0	47.7	0.0	39.8	42.3	34.7	31.9	47.3	0.0	0.0
Incr Delay (d2), s/veh	4.7	13.3	0.1	22.8	0.0	101.9	290.8	0.2	0.0	437.6	0.0	0.0
Initial Q Delay(d3),s/veh	0.0	0.0	0.0	0.0	0.0	0.0	0.0	0.0	0.0	0.0	0.0	0.0
%ile BackOfQ(50%),veh/ln	2.5	10.9	0.9	8.3	0.0	31.3	50.3	4.2	0.7	45.1	0.0	0.0
Unsig. Movement Delay, s/veh												
LnGrp Delay(d),s/veh	57.8	56.7	36.1	70.5	0.0	141.6	333.1	34.9	31.9	484.8	0.0	0.0
LnGrp LOS	E	E	D	E	A	F	F	C	C	F	A	A
Approach Vol, veh/h		483			915			982			586	
Approach Delay, s/veh		55.2			122.8			264.9			484.8	
Approach LOS		E			F			F			F	
Timer - Assigned Phs	1	2		4	5	6		8				
Phs Duration (G+Y+Rc), s	22.8	30.9		25.1	12.7	41.0		35.8				
Change Period (Y+Rc), s	5.4	6.0		5.1	5.8	6.0		5.8				
Max Green Setting (Gmax), s	20.0	30.0		20.0	20.0	30.0		30.0				
Max Q Clear Time (g_c+I1), s	17.3	23.2		22.0	7.3	37.0		32.0				
Green Ext Time (p_c), s	0.1	0.7		0.0	0.1	0.0		0.0				
<b>Intersection Summary</b>												
HCM 6th Ctrl Delay	230.4											
HCM 6th LOS	F											
<b>Notes</b>												
User approved pedestrian interval to be less than phase max green.												

# HCM 6th Signalized Intersection Summary

## 6: Old Redwood Hwy & Airport Blvd

Cumulative Conditions AM



Movement	EBL	EBT	EBR	WBL	WBT	WBR	NBL	NBT	NBR	SBL	SBT	SBR
Lane Configurations												
Traffic Volume (veh/h)	40	160	360	40	310	40	360	200	20	40	850	80
Future Volume (veh/h)	40	160	360	40	310	40	360	200	20	40	850	80
Initial Q (Qb), veh	0	0	0	0	0	0	0	0	0	0	0	0
Ped-Bike Adj(A_pbT)	1.00		0.99	1.00		0.99	1.00		0.99	1.00		0.99
Parking Bus, Adj	1.00	1.00	1.00	1.00	1.00	1.00	1.00	1.00	1.00	1.00	1.00	1.00
Work Zone On Approach		No			No			No			No	
Adj Sat Flow, veh/h/ln	1870	1870	1870	1870	1870	1870	1870	1870	1870	1870	1870	1870
Adj Flow Rate, veh/h	42	168	66	42	326	37	379	211	9	42	895	25
Peak Hour Factor	0.95	0.95	0.95	0.95	0.95	0.95	0.95	0.95	0.95	0.95	0.95	0.95
Percent Heavy Veh, %	2	2	2	2	2	2	2	2	2	2	2	2
Cap, veh/h	53	430	361	53	365	41	376	930	784	53	591	497
Arrive On Green	0.03	0.23	0.23	0.03	0.22	0.22	0.21	0.50	0.50	0.03	0.32	0.32
Sat Flow, veh/h	1781	1870	1568	1781	1648	187	1781	1870	1577	1781	1870	1573
Grp Volume(v), veh/h	42	168	66	42	0	363	379	211	9	42	895	25
Grp Sat Flow(s),veh/h/ln	1781	1870	1568	1781	0	1835	1781	1870	1577	1781	1870	1573
Q Serve(g_s), s	2.2	7.2	3.2	2.2	0.0	18.2	20.0	6.1	0.3	2.2	30.0	1.0
Cycle Q Clear(g_c), s	2.2	7.2	3.2	2.2	0.0	18.2	20.0	6.1	0.3	2.2	30.0	1.0
Prop In Lane	1.00		1.00	1.00		0.10	1.00		1.00	1.00		1.00
Lane Grp Cap(c), veh/h	53	430	361	53	0	407	376	930	784	53	591	497
V/C Ratio(X)	0.79	0.39	0.18	0.79	0.00	0.89	1.01	0.23	0.01	0.79	1.51	0.05
Avail Cap(c_a), veh/h	225	789	661	225	0	503	376	930	784	188	591	497
HCM Platoon Ratio	1.00	1.00	1.00	1.00	1.00	1.00	1.00	1.00	1.00	1.00	1.00	1.00
Upstream Filter(I)	1.00	1.00	1.00	1.00	0.00	1.00	1.00	1.00	1.00	1.00	1.00	1.00
Uniform Delay (d), s/veh	45.7	30.9	29.4	45.7	0.0	35.8	37.4	13.5	12.1	45.7	32.4	22.5
Incr Delay (d2), s/veh	9.3	0.2	0.1	9.2	0.0	13.9	48.8	0.0	0.0	9.3	239.6	0.0
Initial Q Delay(d3),s/veh	0.0	0.0	0.0	0.0	0.0	0.0	0.0	0.0	0.0	0.0	0.0	0.0
%ile BackOfQ(50%),veh/ln	1.1	3.2	1.2	1.1	0.0	9.6	13.5	2.4	0.1	1.1	52.3	0.4
Unsig. Movement Delay, s/veh												
LnGrp Delay(d),s/veh	55.0	31.1	29.4	54.9	0.0	49.7	86.2	13.6	12.1	55.0	272.0	22.5
LnGrp LOS	E	C	C	D	A	D	F	B	B	E	F	C
Approach Vol, veh/h		276			405			599			962	
Approach Delay, s/veh		34.3			50.2			59.5			256.0	
Approach LOS		C			D			E			F	
Timer - Assigned Phs	1	2	3	4	5	6	7	8				
Phs Duration (G+Y+Rc), s	7.4	27.2	25.1	35.1	8.2	26.4	7.9	52.3				
Change Period (Y+Rc), s	4.6	5.4	5.1	5.1	5.4	* 5.4	5.1	5.1				
Max Green Setting (Gmax)	12.0	40.0	20.0	30.0	12.0	* 26	10.0	30.0				
Max Q Clear Time (g_c+1/2)	11.2	9.2	22.0	32.0	4.2	20.2	4.2	8.1				
Green Ext Time (p_c), s	0.0	0.3	0.0	0.0	0.0	0.5	0.0	0.4				

### Intersection Summary

HCM 6th Ctrl Delay	139.1
HCM 6th LOS	F

### Notes

- User approved pedestrian interval to be less than phase max green.
- \* HCM 6th computational engine requires equal clearance times for the phases crossing the barrier.



HCM 6th TWSC

7: Old Redwood Hwy & Creekside Apts/Faught Rd

Cumulative Conditions AM

Intersection												
Int Delay, s/veh	246.5											
Movement	EBL	EBT	EBR	WBL	WBT	WBR	NBL	NBT	NBR	SBL	SBT	SBR
Lane Configurations		↕			↕		↑	↑	↑		↕	
Traffic Vol, veh/h	60	20	30	180	20	20	20	420	110	30	1100	30
Future Vol, veh/h	60	20	30	180	20	20	20	420	110	30	1100	30
Conflicting Peds, #/hr	0	0	0	0	0	0	0	0	0	0	0	0
Sign Control	Stop	Stop	Stop	Stop	Stop	Stop	Free	Free	Free	Free	Free	Free
RT Channelized	-	-	None	-	-	None	-	-	None	-	-	None
Storage Length	-	-	-	-	-	-	50	-	270	-	-	-
Veh in Median Storage, #	-	0	-	-	0	-	-	0	-	-	0	-
Grade, %	-	0	-	-	0	-	-	0	-	-	0	-
Peak Hour Factor	95	95	95	95	95	95	95	95	95	95	95	95
Heavy Vehicles, %	2	2	2	2	2	2	2	2	2	2	2	2
Mvmt Flow	63	21	32	189	21	21	21	442	116	32	1158	32

Major/Minor	Minor2		Minor1		Major1			Major2				
Conflicting Flow All	1801	1838	1174	1749	1738	442	1190	0	0	558	0	0
Stage 1	1238	1238	-	484	484	-	-	-	-	-	-	-
Stage 2	563	600	-	1265	1254	-	-	-	-	-	-	-
Critical Hdwy	7.12	6.52	6.22	7.12	6.52	6.22	4.12	-	-	4.12	-	-
Critical Hdwy Stg 1	6.12	5.52	-	6.12	5.52	-	-	-	-	-	-	-
Critical Hdwy Stg 2	6.12	5.52	-	6.12	5.52	-	-	-	-	-	-	-
Follow-up Hdwy	3.518	4.018	3.318	3.518	4.018	3.318	2.218	-	-	2.218	-	-
Pot Cap-1 Maneuver	~ 62	76	234	~ 67	87	615	587	-	-	1013	-	-
Stage 1	215	248	-	564	552	-	-	-	-	-	-	-
Stage 2	511	490	-	208	243	-	-	-	-	-	-	-
Platoon blocked, %								-	-	-	-	-
Mov Cap-1 Maneuver	~ 43	66	234	~ 40	76	615	587	-	-	1013	-	-
Mov Cap-2 Maneuver	~ 43	66	-	~ 40	76	-	-	-	-	-	-	-
Stage 1	207	225	-	544	532	-	-	-	-	-	-	-
Stage 2	457	472	-	~ 148	220	-	-	-	-	-	-	-






















Approach	EB		WB		NB		SB	
HCM Control Delay, s/\$	583.8		1991.6		0.4		0.2	
HCM LOS	F		F					

Minor Lane/Major Mvmt	NBL	NBT	NBR	EBLn1	WBLn1	SBL	SBT	SBR
Capacity (veh/h)	587	-	-	60	46	1013	-	-
HCM Lane V/C Ratio	0.036	-	-	1.93	5.034	0.031	-	-
HCM Control Delay (s)	11.4	-	-	\$ 583.8	\$ 1991.6	8.7	0	-
HCM Lane LOS	B	-	-	F	F	A	A	-
HCM 95th %tile Q(veh)	0.1	-	-	10.9	26.5	0.1	-	-

Notes  
 -: Volume exceeds capacity    \$: Delay exceeds 300s    +: Computation Not Defined    \*: All major volume in platoon

HCM 6th Signalized Intersection Summary  
 8: Old Redwood Hwy & Mark West Commons Cir/Wikiup Dr

Cumulative Conditions AM

												
Movement	EBL	EBT	EBR	WBL	WBT	WBR	NBL	NBT	NBR	SBL	SBT	SBR
Lane Configurations												
Traffic Volume (veh/h)	30	20	30	180	20	40	20	410	150	240	950	20
Future Volume (veh/h)	30	20	30	180	20	40	20	410	150	240	950	20
Initial Q (Qb), veh	0	0	0	0	0	0	0	0	0	0	0	0
Ped-Bike Adj(A_pbT)	0.99		0.99	0.99		0.99	1.00		0.99	1.00		1.00
Parking Bus, Adj	1.00	1.00	1.00	1.00	1.00	1.00	1.00	1.00	1.00	1.00	1.00	1.00
Work Zone On Approach		No			No			No			No	
Adj Sat Flow, veh/h/ln	1870	1870	1870	1870	1870	1870	1870	1870	1870	1870	1870	1870
Adj Flow Rate, veh/h	32	21	6	189	21	7	21	432	52	253	1000	10
Peak Hour Factor	0.95	0.95	0.95	0.95	0.95	0.95	0.95	0.95	0.95	0.95	0.95	0.95
Percent Heavy Veh, %	2	2	2	2	2	2	2	2	2	2	2	2
Cap, veh/h	134	73	13	356	27	342	35	674	567	302	954	805
Arrive On Green	0.22	0.22	0.22	0.22	0.22	0.22	0.02	0.36	0.36	0.17	0.51	0.51
Sat Flow, veh/h	183	335	59	1097	122	1567	1781	1870	1574	1781	1870	1577
Grp Volume(v), veh/h	59	0	0	210	0	7	21	432	52	253	1000	10
Grp Sat Flow(s),veh/h/ln	576	0	0	1219	0	1567	1781	1870	1574	1781	1870	1577
Q Serve(g_s), s	0.3	0.0	0.0	0.0	0.0	0.2	0.7	11.3	1.3	8.1	30.0	0.2
Cycle Q Clear(g_c), s	10.4	0.0	0.0	10.0	0.0	0.2	0.7	11.3	1.3	8.1	30.0	0.2
Prop In Lane	0.54		0.10	0.90		1.00	1.00		1.00	1.00		1.00
Lane Grp Cap(c), veh/h	220	0	0	382	0	342	35	674	567	302	954	805
V/C Ratio(X)	0.27	0.00	0.00	0.55	0.00	0.02	0.60	0.64	0.09	0.84	1.05	0.01
Avail Cap(c_a), veh/h	220	0	0	675	0	666	364	954	803	364	954	805
HCM Platoon Ratio	1.00	1.00	1.00	1.00	1.00	1.00	1.00	1.00	1.00	1.00	1.00	1.00
Upstream Filter(I)	1.00	0.00	0.00	1.00	0.00	1.00	1.00	1.00	1.00	1.00	1.00	1.00
Uniform Delay (d), s/veh	19.2	0.0	0.0	21.9	0.0	18.0	28.6	15.6	12.4	23.6	14.4	7.1
Incr Delay (d2), s/veh	0.2	0.0	0.0	0.5	0.0	0.0	5.9	0.4	0.0	11.7	42.4	0.0
Initial Q Delay(d3),s/veh	0.0	0.0	0.0	0.0	0.0	0.0	0.0	0.0	0.0	0.0	0.0	0.0
%ile BackOfQ(50%),veh/ln	0.6	0.0	0.0	2.6	0.0	0.1	0.3	4.2	0.4	4.1	20.8	0.0
Unsig. Movement Delay, s/veh												
LnGrp Delay(d),s/veh	19.4	0.0	0.0	22.3	0.0	18.1	34.4	16.0	12.5	35.3	56.8	7.1
LnGrp LOS	B	A	A	C	A	B	C	B	B	D	F	A
Approach Vol, veh/h		59			217			505			1263	
Approach Delay, s/veh		19.4			22.2			16.4			52.1	
Approach LOS		B			C			B			D	
Timer - Assigned Phs		2	3	4		6	7	8				
Phs Duration (G+Y+Rc), s		17.4	6.3	35.1		17.4	15.1	26.3				
Change Period (Y+Rc), s		4.6	5.1	5.1		4.6	5.1	5.1				
Max Green Setting (Gmax), s		12.0	12.0	30.0		25.0	12.0	30.0				
Max Q Clear Time (g_c+I1), s		12.4	2.7	32.0		12.0	10.1	13.3				
Green Ext Time (p_c), s		0.0	0.0	0.0		0.7	0.1	1.2				
<b>Intersection Summary</b>												
HCM 6th Ctrl Delay				39.2								
HCM 6th LOS				D								
<b>Notes</b>												
User approved pedestrian interval to be less than phase max green.												

**Intersection**

Int Delay, s/veh 100.5

Movement	EBL	EBT	WBT	WBR	SBL	SBR
Lane Configurations		↕	↑	↗	↖	↗
Traffic Vol, veh/h	100	340	220	210	470	40
Future Vol, veh/h	100	340	220	210	470	40
Conflicting Peds, #/hr	0	0	0	0	0	0
Sign Control	Free	Free	Free	Free	Stop	Stop
RT Channelized	-	None	-	Yield	-	None
Storage Length	-	-	-	150	90	0
Veh in Median Storage, #	-	0	0	-	0	-
Grade, %	-	0	0	-	0	-
Peak Hour Factor	95	95	95	95	95	95
Heavy Vehicles, %	2	2	2	2	2	2
Mvmt Flow	105	358	232	221	495	42

**Major/Minor**

	Major1	Major2	Minor2		
Conflicting Flow All	232	0	0	800	232
Stage 1	-	-	-	232	-
Stage 2	-	-	-	568	-
Critical Hdwy	4.12	-	-	6.42	6.22
Critical Hdwy Stg 1	-	-	-	5.42	-
Critical Hdwy Stg 2	-	-	-	5.42	-
Follow-up Hdwy	2.218	-	-	3.518	3.318
Pot Cap-1 Maneuver	1336	-	-	~ 354	807
Stage 1	-	-	-	807	-
Stage 2	-	-	-	567	-
Platoon blocked, %		-	-		
Mov Cap-1 Maneuver	1336	-	-	~ 319	807
Mov Cap-2 Maneuver	-	-	-	~ 319	-
Stage 1	-	-	-	728	-
Stage 2	-	-	-	567	-

**Approach**

	EB	WB	SB
HCM Control Delay, s	1.8	0	270.5
HCM LOS			F

**Minor Lane/Major Mvmt**




















	EBL	EBT	WBT	WBR	SBLn1	SBLn2
Capacity (veh/h)	1336	-	-	-	319	807
HCM Lane V/C Ratio	0.079	-	-	-	1.551	0.052
HCM Control Delay (s)	7.9	0	-	-	292.7	9.7
HCM Lane LOS	A	A	-	-	F	A
HCM 95th %tile Q(veh)	0.3	-	-	-	28.5	0.2

**Notes**

-: Volume exceeds capacity    \$: Delay exceeds 300s    +: Computation Not Defined    \*: All major volume in platoon

HCM 6th Signalized Intersection Summary  
 10: Gravenstein Hwy & Graton Rd/Frei Rd

Cumulative Conditions AM

												
Movement	EBL	EBT	EBR	WBL	WBT	WBR	NBL	NBT	NBR	SBL	SBT	SBR
Lane Configurations												
Traffic Volume (veh/h)	50	80	170	140	70	20	110	450	170	20	510	40
Future Volume (veh/h)	50	80	170	140	70	20	110	450	170	20	510	40
Initial Q (Qb), veh	0	0	0	0	0	0	0	0	0	0	0	0
Ped-Bike Adj(A_pbT)	0.99		0.99	0.99		0.99	1.00		0.99	1.00		0.99
Parking Bus, Adj	1.00	1.00	1.00	1.00	1.00	1.00	1.00	1.00	1.00	1.00	1.00	1.00
Work Zone On Approach		No			No			No			No	
Adj Sat Flow, veh/h/ln	1870	1870	1870	1870	1870	1870	1870	1870	1870	1870	1870	1870
Adj Flow Rate, veh/h	53	84	30	147	74	19	116	474	174	21	537	40
Peak Hour Factor	0.95	0.95	0.95	0.95	0.95	0.95	0.95	0.95	0.95	0.95	0.95	0.95
Percent Heavy Veh, %	2	2	2	2	2	2	2	2	2	2	2	2
Cap, veh/h	192	271	371	243	107	22	292	594	218	104	603	45
Arrive On Green	0.24	0.24	0.24	0.24	0.24	0.24	0.16	0.46	0.46	0.06	0.35	0.35
Sat Flow, veh/h	482	1146	1568	644	452	94	1781	1303	478	1781	1718	128
Grp Volume(v), veh/h	137	0	30	240	0	0	116	0	648	21	0	577
Grp Sat Flow(s),veh/h/ln	1628	0	1568	1190	0	0	1781	0	1781	1781	0	1846
Q Serve(g_s), s	0.0	0.0	1.0	8.9	0.0	0.0	3.7	0.0	19.9	0.7	0.0	18.9
Cycle Q Clear(g_c), s	4.0	0.0	1.0	12.9	0.0	0.0	3.7	0.0	19.9	0.7	0.0	18.9
Prop In Lane	0.39		1.00	0.61		0.08	1.00		0.27	1.00		0.07
Lane Grp Cap(c), veh/h	463	0	371	372	0	0	292	0	813	104	0	648
V/C Ratio(X)	0.30	0.00	0.08	0.64	0.00	0.00	0.40	0.00	0.80	0.20	0.00	0.89
Avail Cap(c_a), veh/h	1335	0	1227	392	0	0	446	0	1394	1394	0	722
HCM Platoon Ratio	1.00	1.00	1.00	1.00	1.00	1.00	1.00	1.00	1.00	1.00	1.00	1.00
Upstream Filter(I)	1.00	0.00	1.00	1.00	0.00	0.00	1.00	0.00	1.00	1.00	0.00	1.00
Uniform Delay (d), s/veh	20.1	0.0	19.0	24.4	0.0	0.0	23.9	0.0	14.8	28.7	0.0	19.6
Incr Delay (d2), s/veh	0.4	0.0	0.1	3.4	0.0	0.0	0.9	0.0	1.8	0.9	0.0	12.4
Initial Q Delay(d3),s/veh	0.0	0.0	0.0	0.0	0.0	0.0	0.0	0.0	0.0	0.0	0.0	0.0
%ile BackOfQ(50%),veh/ln	1.6	0.0	0.3	3.5	0.0	0.0	1.5	0.0	6.6	0.3	0.0	8.9
Unsig. Movement Delay, s/veh												
LnGrp Delay(d),s/veh	20.5	0.0	19.1	27.8	0.0	0.0	24.8	0.0	16.7	29.6	0.0	32.0
LnGrp LOS	C	A	B	C	A	A	C	A	B	C	A	C
Approach Vol, veh/h		167			240			764			598	
Approach Delay, s/veh		20.2			27.8			17.9			31.9	
Approach LOS		C			C			B			C	
Timer - Assigned Phs	1	2		4	5	6		8				
Phs Duration (G+Y+Rc), s	15.2	28.2		20.5	8.4	35.0		20.5				
Change Period (Y+Rc), s	* 4.7	5.8		5.4	* 4.7	5.8		5.4				
Max Green Setting (Gmax), s	* 16	25.0		16.0	* 50	50.0		50.0				
Max Q Clear Time (g_c+I1), s	5.7	20.9		14.9	2.7	21.9		6.0				
Green Ext Time (p_c), s	0.2	1.3		0.1	0.0	4.4		0.9				
<b>Intersection Summary</b>												
HCM 6th Ctrl Delay			24.2									
HCM 6th LOS			C									
<b>Notes</b>												
User approved pedestrian interval to be less than phase max green.												
* HCM 6th computational engine requires equal clearance times for the phases crossing the barrier.												

HCM 6th TWSC  
11: Private Dwy/Moorland Ave & Todd Rd

Cumulative Conditions AM

Intersection

Int Delay, s/veh 302.9

Movement	EBL	EBT	EBR	WBL	WBT	WBR	NBL	NBT	NBR	SBL	SBT	SBR
Lane Configurations	↖	↗		↖	↗			↕			↖	↗
Traffic Vol, veh/h	70	450	20	20	510	390	20	20	20	330	20	90
Future Vol, veh/h	70	450	20	20	510	390	20	20	20	330	20	90
Conflicting Peds, #/hr	0	0	0	0	0	0	0	0	0	0	0	0
Sign Control	Free	Free	Free	Free	Free	Free	Stop	Stop	Stop	Stop	Stop	Stop
RT Channelized	-	-	None	-	-	None	-	-	None	-	-	None
Storage Length	100	-	-	70	-	-	-	-	-	-	-	60
Veh in Median Storage, #	-	0	-	-	0	-	-	0	-	-	0	-
Grade, %	-	0	-	-	0	-	-	0	-	-	0	-
Peak Hour Factor	95	95	95	95	95	95	95	95	95	95	95	95
Heavy Vehicles, %	2	2	2	2	2	2	2	2	2	2	2	2
Mvmt Flow	74	474	21	21	537	411	21	21	21	347	21	95

Major/Minor	Major1			Major2			Minor1			Minor2		
Conflicting Flow All	948	0	0	495	0	0	1476	1623	485	1439	1428	743
Stage 1	-	-	-	-	-	-	633	633	-	785	785	-
Stage 2	-	-	-	-	-	-	843	990	-	654	643	-
Critical Hdwy	4.12	-	-	4.12	-	-	7.12	6.52	6.22	7.12	6.52	6.22
Critical Hdwy Stg 1	-	-	-	-	-	-	6.12	5.52	-	6.12	5.52	-
Critical Hdwy Stg 2	-	-	-	-	-	-	6.12	5.52	-	6.12	5.52	-
Follow-up Hdwy	2.218	-	-	2.218	-	-	3.518	4.018	3.318	3.518	4.018	3.318
Pot Cap-1 Maneuver	724	-	-	1069	-	-	104	103	582	~ 111	135	415
Stage 1	-	-	-	-	-	-	468	473	-	386	404	-
Stage 2	-	-	-	-	-	-	358	324	-	456	468	-
Platoon blocked, %		-	-		-	-						
Mov Cap-1 Maneuver	724	-	-	1069	-	-	63	91	582	~ 80	119	415
Mov Cap-2 Maneuver	-	-	-	-	-	-	63	91	-	~ 80	119	-
Stage 1	-	-	-	-	-	-	420	425	-	~ 347	396	-
Stage 2	-	-	-	-	-	-	256	318	-	375	420	-

Approach	EB			WB			NB			SB		
HCM Control Delay, s	1.4			0.2			81.2			\$ 1335.9		
HCM LOS							F			F		

Minor Lane/Major Mvmt	NBLn1	EBL	EBT	EBR	WBL	WBT	WBR	SBLn1	SBLn2
Capacity (veh/h)	105	724	-	-	1069	-	-	82	415
HCM Lane V/C Ratio	0.602	0.102	-	-	0.02	-	-	4.493	0.228
HCM Control Delay (s)	81.2	10.5	-	-	8.4	-	-	\$ 1675.3	16.2
HCM Lane LOS	F	B	-	-	A	-	-	F	C
HCM 95th %tile Q(veh)	2.9	0.3	-	-	0.1	-	-	39.3	0.9





















Notes

~: Volume exceeds capacity    \$: Delay exceeds 300s    +: Computation Not Defined    \*: All major volume in platoon

# HCM 6th Signalized Intersection Summary

## 12: S Moreland Ave & Todd Rd

Cumulative Conditions AM

												
Movement	EBL	EBT	EBR	WBL	WBT	WBR	NBL	NBT	NBR	SBL	SBT	SBR
Lane Configurations												
Traffic Volume (veh/h)	0	390	410	400	330	0	590	0	140	0	0	0
Future Volume (veh/h)	0	390	410	400	330	0	590	0	140	0	0	0
Initial Q (Qb), veh	0	0	0	0	0	0	0	0	0	0	0	0
Ped-Bike Adj(A_pbT)	1.00		1.00	1.00		1.00	1.00		1.00	1.00		1.00
Parking Bus, Adj	1.00	1.00	1.00	1.00	1.00	1.00	1.00	1.00	1.00	1.00	1.00	1.00
Work Zone On Approach		No			No			No			No	
Adj Sat Flow, veh/h/ln	1870	1870	1870	1870	1870	1870	1870	1870	1870	1870	1870	1870
Adj Flow Rate, veh/h	0	411	195	421	347	0	621	0	94	0	0	0
Peak Hour Factor	0.95	0.95	0.95	0.95	0.95	0.95	0.95	0.95	0.95	0.95	0.95	0.95
Percent Heavy Veh, %	2	2	2	2	2	2	2	2	2	2	2	2
Cap, veh/h	0	467	395	509	534	0	606	0	1078	0	3	0
Arrive On Green	0.00	0.25	0.25	0.29	0.29	0.00	0.34	0.00	0.34	0.00	0.00	0.00
Sat Flow, veh/h	0	1870	1585	1781	1870	0	1781	0	3170	0	1870	0
Grp Volume(v), veh/h	0	411	195	421	347	0	621	0	94	0	0	0
Grp Sat Flow(s),veh/h/ln	0	1870	1585	1781	1870	0	1781	0	1585	0	1870	0
Q Serve(g_s), s	0.0	15.5	7.7	16.3	12.0	0.0	25.0	0.0	1.5	0.0	0.0	0.0
Cycle Q Clear(g_c), s	0.0	15.5	7.7	16.3	12.0	0.0	25.0	0.0	1.5	0.0	0.0	0.0
Prop In Lane	0.00		1.00	1.00		0.00	1.00		1.00	0.00		0.00
Lane Grp Cap(c), veh/h	0	467	395	509	534	0	606	0	1078	0	3	0
V/C Ratio(X)	0.00	0.88	0.49	0.83	0.65	0.00	1.03	0.00	0.09	0.00	0.00	0.00
Avail Cap(c_a), veh/h	0	509	431	727	763	0	606	0	1078	0	203	0
HCM Platoon Ratio	1.00	1.00	1.00	1.00	1.00	1.00	1.00	1.00	1.00	1.00	1.00	1.00
Upstream Filter(I)	0.00	1.00	1.00	1.00	1.00	0.00	1.00	0.00	1.00	0.00	0.00	0.00
Uniform Delay (d), s/veh	0.0	26.5	23.6	24.6	23.0	0.0	24.3	0.0	16.5	0.0	0.0	0.0
Incr Delay (d2), s/veh	0.0	15.5	1.0	5.4	1.3	0.0	43.2	0.0	0.0	0.0	0.0	0.0
Initial Q Delay(d3),s/veh	0.0	0.0	0.0	0.0	0.0	0.0	0.0	0.0	0.0	0.0	0.0	0.0
%ile BackOfQ(50%),veh/ln	0.0	8.4	2.8	7.1	5.1	0.0	17.0	0.0	0.5	0.0	0.0	0.0
Unsig. Movement Delay, s/veh												
LnGrp Delay(d),s/veh	0.0	42.0	24.6	30.0	24.4	0.0	67.5	0.0	16.5	0.0	0.0	0.0
LnGrp LOS	A	D	C	C	C	A	F	A	B	A	A	A
Approach Vol, veh/h		606			768			715				0
Approach Delay, s/veh		36.4			27.5			60.8				0.0
Approach LOS		D			C			E				
Timer - Assigned Phs		2		4		6		8				
Phs Duration (G+Y+Rc), s		0.0		21.5		28.0		24.0				
Change Period (Y+Rc), s		3.0		3.2		3.0		3.0				
Max Green Setting (Gmax), s		8.0		20.0		25.0		30.0				
Max Q Clear Time (g_c+I1), s		0.0		17.5		27.0		18.3				
Green Ext Time (p_c), s		0.0		0.8		0.0		2.7				

### Intersection Summary

HCM 6th Ctrl Delay	41.5
HCM 6th LOS	D

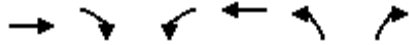
### Notes

- User approved pedestrian interval to be less than phase max green.
- User approved volume balancing among the lanes for turning movement.

# HCM 6th Signalized Intersection Summary

## 13: Todd Rd Overpass & Todd Rd

Cumulative Conditions AM



Movement	EBT	EBR	WBL	WBT	NBL	NBR
Lane Configurations	↑↑	↗	↖	↑↑	↖	↗
Traffic Volume (veh/h)	210	270	390	290	250	520
Future Volume (veh/h)	210	270	390	290	250	520
Initial Q (Qb), veh	0	0	0	0	0	0
Ped-Bike Adj(A_pbT)		1.00	1.00		1.00	1.00
Parking Bus, Adj	1.00	1.00	1.00	1.00	1.00	1.00
Work Zone On Approach	No			No	No	
Adj Sat Flow, veh/h/ln	1870	1870	1870	1870	1870	1870
Adj Flow Rate, veh/h	221	48	411	305	263	292
Peak Hour Factor	0.95	0.95	0.95	0.95	0.95	0.95
Percent Heavy Veh, %	2	2	2	2	2	2
Cap, veh/h	524	234	992	521	422	1438
Arrive On Green	0.15	0.15	0.28	0.28	0.24	0.24
Sat Flow, veh/h	3647	1585	3563	1870	1781	2790
Grp Volume(v), veh/h	221	48	411	305	263	292
Grp Sat Flow(s),veh/h/ln	1777	1585	1781	1870	1781	1395
Q Serve(g_s), s	1.8	0.8	2.9	4.4	4.1	1.8
Cycle Q Clear(g_c), s	1.8	0.8	2.9	4.4	4.1	1.8
Prop In Lane		1.00	1.00		1.00	1.00
Lane Grp Cap(c), veh/h	524	234	992	521	422	1438
V/C Ratio(X)	0.42	0.21	0.41	0.59	0.62	0.20
Avail Cap(c_a), veh/h	2281	1017	1715	900	800	2030
HCM Platoon Ratio	1.00	1.00	1.00	1.00	1.00	1.00
Upstream Filter(I)	1.00	1.00	1.00	1.00	1.00	1.00
Uniform Delay (d), s/veh	12.1	11.7	9.2	9.7	10.6	4.1
Incr Delay (d2), s/veh	0.5	0.4	0.3	1.0	1.5	0.1
Initial Q Delay(d3),s/veh	0.0	0.0	0.0	0.0	0.0	0.0
%ile BackOfQ(50%),veh/ln	0.6	0.3	0.8	1.4	1.3	0.6
Unsig. Movement Delay, s/veh						
LnGrp Delay(d),s/veh	12.6	12.1	9.4	10.7	12.1	4.2
LnGrp LOS	B	B	A	B	B	A
Approach Vol, veh/h	269			716	555	
Approach Delay, s/veh	12.5			10.0	7.9	
Approach LOS	B			A	A	
Timer - Assigned Phs		2			6	8
Phs Duration (G+Y+Rc), s		8.1			12.2	10.9
Change Period (Y+Rc), s		3.5			3.5	3.5
Max Green Setting (Gmax), s		20.0			15.0	14.0
Max Q Clear Time (g_c+I1), s		3.8			6.4	6.1
Green Ext Time (p_c), s		1.3			2.3	1.3
<b>Intersection Summary</b>						
HCM 6th Ctrl Delay			9.7			
HCM 6th LOS			A			
<b>Notes</b>						
User approved volume balancing among the lanes for turning movement.						

# HCM 6th Signalized Intersection Summary

## 14: Santa Rosa Ave & Todd Rd

Cumulative Conditions AM



Movement	EBL	EBT	EBR	WBL	WBT	WBR	NBL	NBT	NBR	SBL	SBT	SBR
Lane Configurations												
Traffic Volume (veh/h)	340	120	270	30	40	40	370	710	50	60	350	270
Future Volume (veh/h)	340	120	270	30	40	40	370	710	50	60	350	270
Initial Q (Qb), veh	0	0	0	0	0	0	0	0	0	0	0	0
Ped-Bike Adj(A_pbT)	1.00		0.99	1.00		1.00	1.00		0.99	1.00		0.99
Parking Bus, Adj	1.00	1.00	1.00	1.00	1.00	1.00	1.00	1.00	1.00	1.00	1.00	1.00
Work Zone On Approach		No			No			No			No	
Adj Sat Flow, veh/h/ln	1870	1870	1870	1870	1870	1870	1870	1870	1870	1870	1870	1870
Adj Flow Rate, veh/h	242	288	47	32	42	1	389	747	19	63	368	49
Peak Hour Factor	0.95	0.95	0.95	0.95	0.95	0.95	0.95	0.95	0.95	0.95	0.95	0.95
Percent Heavy Veh, %	2	2	2	2	2	2	2	2	2	2	2	2
Cap, veh/h	352	370	311	86	87	2	439	1251	554	79	552	244
Arrive On Green	0.20	0.20	0.20	0.05	0.05	0.05	0.25	0.35	0.35	0.04	0.16	0.16
Sat Flow, veh/h	1781	1870	1573	1781	1819	43	1781	3554	1574	1781	3554	1570
Grp Volume(v), veh/h	242	288	47	32	0	43	389	747	19	63	368	49
Grp Sat Flow(s),veh/h/ln	1781	1870	1573	1781	0	1863	1781	1777	1574	1781	1777	1570
Q Serve(g_s), s	7.4	8.6	1.5	1.0	0.0	1.3	12.4	10.1	0.5	2.1	5.7	1.6
Cycle Q Clear(g_c), s	7.4	8.6	1.5	1.0	0.0	1.3	12.4	10.1	0.5	2.1	5.7	1.6
Prop In Lane	1.00		1.00	1.00		0.02	1.00		1.00	1.00		1.00
Lane Grp Cap(c), veh/h	352	370	311	86	0	90	439	1251	554	79	552	244
V/C Ratio(X)	0.69	0.78	0.15	0.37	0.00	0.48	0.89	0.60	0.03	0.79	0.67	0.20
Avail Cap(c_a), veh/h	546	573	482	303	0	317	516	1453	643	303	968	428
HCM Platoon Ratio	1.00	1.00	1.00	1.00	1.00	1.00	1.00	1.00	1.00	1.00	1.00	1.00
Upstream Filter(I)	1.00	1.00	1.00	1.00	0.00	1.00	1.00	1.00	1.00	1.00	1.00	1.00
Uniform Delay (d), s/veh	21.9	22.3	19.5	27.1	0.0	27.2	21.3	15.6	12.5	27.8	23.4	21.6
Incr Delay (d2), s/veh	0.9	1.4	0.1	1.0	0.0	1.5	13.8	0.2	0.0	6.5	0.5	0.1
Initial Q Delay(d3),s/veh	0.0	0.0	0.0	0.0	0.0	0.0	0.0	0.0	0.0	0.0	0.0	0.0
%ile BackOfQ(50%),veh/ln	2.9	3.6	0.5	0.4	0.0	0.6	6.3	3.6	0.1	0.9	2.2	0.5
Unsig. Movement Delay, s/veh												
LnGrp Delay(d),s/veh	22.8	23.8	19.6	28.1	0.0	28.7	35.1	15.8	12.5	34.3	23.9	21.8
LnGrp LOS	C	C	B	C	A	C	D	B	B	C	C	C
Approach Vol, veh/h		577			75			1155			480	
Approach Delay, s/veh		23.0			28.4			22.3			25.0	
Approach LOS		C			C			C			C	
Timer - Assigned Phs		2	3	4		6	7	8				
Phs Duration (G+Y+Rc), s		16.7	19.6	14.5		7.9	8.0	26.1				
Change Period (Y+Rc), s		5.1	5.1	5.4		5.1	5.4	* 5.4				
Max Green Setting (Gmax), s		18.0	17.0	16.0		10.0	10.0	* 24				
Max Q Clear Time (g_c+I1), s		10.6	14.4	7.7		3.3	4.1	12.1				
Green Ext Time (p_c), s		0.8	0.1	0.8		0.0	0.0	2.2				

### Intersection Summary

HCM 6th Ctrl Delay	23.2
HCM 6th LOS	C

### Notes

- User approved pedestrian interval to be less than phase max green.
- User approved volume balancing among the lanes for turning movement.
- \* HCM 6th computational engine requires equal clearance times for the phases crossing the barrier.



HCM 6th AWSC  
 15: Arnold Dr & Warm Springs Rd/Private Dwy

Cumulative Conditions AM

Intersection

Intersection Delay, s/veh 13.6

Intersection LOS B

Movement	EBL	EBT	EBR	WBL	WBT	WBR	NBL	NBT	NBR	SBL	SBT	SBR
Lane Configurations		↕			↕			↕			↕	
Traffic Vol, veh/h	50	20	270	20	20	20	140	130	20	20	220	50
Future Vol, veh/h	50	20	270	20	20	20	140	130	20	20	220	50
Peak Hour Factor	0.95	0.95	0.95	0.95	0.95	0.95	0.95	0.95	0.95	0.95	0.95	0.95
Heavy Vehicles, %	2	2	2	2	2	2	2	2	2	2	2	2
Mvmt Flow	53	21	284	21	21	21	147	137	21	21	232	53
Number of Lanes	0	1	0	0	1	0	0	1	0	0	1	0

Approach	EB	WB	NB	SB
Opposing Approach	WB	EB	SB	NB
Opposing Lanes	1	1	1	1
Conflicting Approach Left SB		NB	EB	WB
Conflicting Lanes Left	1	1	1	1
Conflicting Approach Right NB		SB	WB	EB
Conflicting Lanes Right	1	1	1	1
HCM Control Delay	14.1	10	13.9	13.5
HCM LOS	B	A	B	B

Lane	NBLn1	EBLn1	WBLn1	SBLn1
Vol Left, %	48%	15%	33%	7%
Vol Thru, %	45%	6%	33%	76%
Vol Right, %	7%	79%	33%	17%
Sign Control	Stop	Stop	Stop	Stop
Traffic Vol by Lane	290	340	60	290
LT Vol	140	50	20	20
Through Vol	130	20	20	220
RT Vol	20	270	20	50
Lane Flow Rate	305	358	63	305
Geometry Grp	1	1	1	1
Degree of Util (X)	0.481	0.525	0.109	0.47
Departure Headway (Hd)	5.678	5.285	6.185	5.544
Convergence, Y/N	Yes	Yes	Yes	Yes
Cap	632	680	575	647
Service Time	3.741	3.347	4.275	3.607
HCM Lane V/C Ratio	0.483	0.526	0.11	0.471
HCM Control Delay	13.9	14.1	10	13.5
HCM Lane LOS	B	B	A	B
HCM 95th-tile Q	2.6	3.1	0.4	2.5

HCM 6th TWSC  
16: Riverside Dr & Verano Ave

Cumulative Conditions AM

Intersection												
Int Delay, s/veh	26.6											
Movement	EBL	EBT	EBR	WBL	WBT	WBR	NBL	NBT	NBR	SBL	SBT	SBR
Lane Configurations												
Traffic Vol, veh/h	50	290	20	100	250	60	30	30	30	140	30	50
Future Vol, veh/h	50	290	20	100	250	60	30	30	30	140	30	50
Conflicting Peds, #/hr	0	0	0	0	0	0	0	0	0	0	0	0
Sign Control	Free	Free	Free	Free	Free	Free	Stop	Stop	Stop	Stop	Stop	Stop
RT Channelized	-	-	None	-	-	None	-	-	None	-	-	None
Storage Length	100	-	-	-	-	-	-	-	-	-	-	-
Veh in Median Storage, #	-	0	-	-	0	-	-	0	-	-	0	-
Grade, %	-	0	-	-	0	-	-	0	-	-	0	-
Peak Hour Factor	95	95	95	95	95	95	95	95	95	95	95	95
Heavy Vehicles, %	2	2	2	2	2	2	2	2	2	2	2	2
Mvmt Flow	53	305	21	105	263	63	32	32	32	147	32	53

Major/Minor	Major1			Major2			Minor1			Minor2		
Conflicting Flow All	326	0	0	326	0	0	969	958	316	959	937	295
Stage 1	-	-	-	-	-	-	422	422	-	505	505	-
Stage 2	-	-	-	-	-	-	547	536	-	454	432	-
Critical Hdwy	4.12	-	-	4.12	-	-	7.12	6.52	6.22	7.12	6.52	6.22
Critical Hdwy Stg 1	-	-	-	-	-	-	6.12	5.52	-	6.12	5.52	-
Critical Hdwy Stg 2	-	-	-	-	-	-	6.12	5.52	-	6.12	5.52	-
Follow-up Hdwy	2.218	-	-	2.218	-	-	3.518	4.018	3.318	3.518	4.018	3.318
Pot Cap-1 Maneuver	1234	-	-	1234	-	-	233	257	724	237	265	744
Stage 1	-	-	-	-	-	-	609	588	-	549	540	-
Stage 2	-	-	-	-	-	-	521	523	-	586	582	-
Platoon blocked, %	-	-	-	-	-	-	-	-	-	-	-	-
Mov Cap-1 Maneuver	1234	-	-	1234	-	-	173	220	724	180	227	744
Mov Cap-2 Maneuver	-	-	-	-	-	-	173	220	-	180	227	-
Stage 1	-	-	-	-	-	-	583	563	-	525	483	-
Stage 2	-	-	-	-	-	-	405	468	-	506	557	-

Approach	EB	WB	NB	SB
HCM Control Delay, s	1.1	2	27.1	113.9
HCM LOS			D	F

Minor Lane/Major Mvmt	NBLn1	EBL	EBT	EBR	WBL	WBT	WBR	SBLn1
Capacity (veh/h)	256	1234	-	-	1234	-	-	225
HCM Lane V/C Ratio	0.37	0.043	-	-	0.085	-	-	1.029
HCM Control Delay (s)	27.1	8	-	-	8.2	0	-	113.9
HCM Lane LOS	D	A	-	-	A	A	-	F
HCM 95th %tile Q(veh)	1.6	0.1	-	-	0.3	-	-	9.7

HCM 6th Signalized Intersection Summary  
 17: Main St/Petaluma Hill Rd & Old Adobe Rd/Adobe Rd

Cumulative Conditions AM



Movement	EBL	EBT	EBR	WBL	WBT	WBR	NBL	NBT	NBR	SBL	SBT	SBR
Lane Configurations		↕			↕			↕		↕	↕	
Traffic Volume (veh/h)	60	260	100	20	130	410	60	280	20	510	650	70
Future Volume (veh/h)	60	260	100	20	130	410	60	280	20	510	650	70
Initial Q (Qb), veh	0	0	0	0	0	0	0	0	0	0	0	0
Ped-Bike Adj(A_pbT)	1.00		0.99	1.00		0.99	1.00		1.00	1.00		0.99
Parking Bus, Adj	1.00	1.00	1.00	1.00	1.00	1.00	1.00	1.00	1.00	1.00	1.00	1.00
Work Zone On Approach		No			No			No			No	
Adj Sat Flow, veh/h/ln	1870	1870	1870	1870	1870	1870	1870	1870	1870	1870	1870	1870
Adj Flow Rate, veh/h	63	274	89	21	137	285	63	295	18	537	684	69
Peak Hour Factor	0.95	0.95	0.95	0.95	0.95	0.95	0.95	0.95	0.95	0.95	0.95	0.95
Percent Heavy Veh, %	2	2	2	2	2	2	2	2	2	2	2	2
Cap, veh/h	113	335	101	71	171	330	74	346	21	386	361	36
Arrive On Green	0.30	0.30	0.30	0.30	0.30	0.30	0.24	0.24	0.24	0.22	0.22	0.22
Sat Flow, veh/h	160	1114	336	39	569	1097	308	1443	88	1781	1669	168
Grp Volume(v), veh/h	426	0	0	443	0	0	376	0	0	537	0	753
Grp Sat Flow(s),veh/h/ln	1610	0	0	1705	0	0	1839	0	0	1781	0	1838
Q Serve(g_s), s	0.5	0.0	0.0	0.0	0.0	0.0	12.4	0.0	0.0	13.7	0.0	13.7
Cycle Q Clear(g_c), s	15.9	0.0	0.0	15.4	0.0	0.0	12.4	0.0	0.0	13.7	0.0	13.7
Prop In Lane	0.15		0.21	0.05		0.64	0.17		0.05	1.00		0.09
Lane Grp Cap(c), veh/h	549	0	0	572	0	0	441	0	0	386	0	398
V/C Ratio(X)	0.78	0.00	0.00	0.77	0.00	0.00	0.85	0.00	0.00	1.39	0.00	1.89
Avail Cap(c_a), veh/h	674	0	0	818	0	0	552	0	0	386	0	398
HCM Platoon Ratio	1.00	1.00	1.00	1.00	1.00	1.00	1.00	1.00	1.00	1.00	1.00	1.00
Upstream Filter(I)	1.00	0.00	0.00	1.00	0.00	0.00	1.00	0.00	0.00	1.00	0.00	1.00
Uniform Delay (d), s/veh	20.7	0.0	0.0	21.0	0.0	0.0	23.0	0.0	0.0	24.8	0.0	24.8
Incr Delay (d2), s/veh	3.5	0.0	0.0	1.7	0.0	0.0	9.6	0.0	0.0	192.1	0.0	411.4
Initial Q Delay(d3),s/veh	0.0	0.0	0.0	0.0	0.0	0.0	0.0	0.0	0.0	0.0	0.0	0.0
%ile BackOfQ(50%),veh/ln	5.8	0.0	0.0	5.6	0.0	0.0	6.2	0.0	0.0	25.8	0.0	50.9
Unsig. Movement Delay, s/veh												
LnGrp Delay(d),s/veh	24.3	0.0	0.0	22.7	0.0	0.0	32.6	0.0	0.0	216.9	0.0	436.2
LnGrp LOS	C	A	A	C	A	A	C	A	A	F	A	F
Approach Vol, veh/h		426			443			376				1290
Approach Delay, s/veh		24.3			22.7			32.6				344.9
Approach LOS		C			C			C				F
Timer - Assigned Phs		2		4		6		8				
Phs Duration (G+Y+Rc), s		19.8		24.4		19.1		24.4				
Change Period (Y+Rc), s		4.6		* 5.4		5.4		5.4				
Max Green Setting (Gmax), s		19.0		* 24		13.7		28.7				
Max Q Clear Time (g_c+I1), s		14.4		17.9		15.7		17.4				
Green Ext Time (p_c), s		0.8		0.6		0.0		0.8				

Intersection Summary

HCM 6th Ctrl Delay	188.4
HCM 6th LOS	F

Notes

User approved pedestrian interval to be less than phase max green.  
 \* HCM 6th computational engine requires equal clearance times for the phases crossing the barrier.

HCM 6th Signalized Intersection Summary  
 18: Old Redwood Hwy & Main St

Cumulative Conditions AM



Movement	WBL	WBR	NBT	NBR	SBL	SBT
Lane Configurations						
Traffic Volume (veh/h)	650	30	270	330	40	680
Future Volume (veh/h)	650	30	270	330	40	680
Initial Q (Qb), veh	0	0	0	0	0	0
Ped-Bike Adj(A_pbT)	1.00	1.00		1.00	1.00	
Parking Bus, Adj	1.00	1.00	1.00	1.00	1.00	1.00
Work Zone On Approach	No		No		No	
Adj Sat Flow, veh/h/ln	1870	1870	1870	1870	1870	1870
Adj Flow Rate, veh/h	684	12	284	347	42	716
Peak Hour Factor	0.95	0.95	0.95	0.95	0.95	0.95
Percent Heavy Veh, %	2	2	2	2	2	2
Cap, veh/h	726	646	518	439	60	773
Arrive On Green	0.41	0.41	0.28	0.28	0.03	0.41
Sat Flow, veh/h	1781	1585	1870	1585	1781	1870
Grp Volume(v), veh/h	684	12	284	347	42	716
Grp Sat Flow(s),veh/h/ln	1781	1585	1870	1585	1781	1870
Q Serve(g_s), s	22.2	0.3	7.8	12.2	1.4	21.9
Cycle Q Clear(g_c), s	22.2	0.3	7.8	12.2	1.4	21.9
Prop In Lane	1.00	1.00		1.00	1.00	
Lane Grp Cap(c), veh/h	726	646	518	439	60	773
V/C Ratio(X)	0.94	0.02	0.55	0.79	0.70	0.93
Avail Cap(c_a), veh/h	888	790	932	790	355	932
HCM Platoon Ratio	1.00	1.00	1.00	1.00	1.00	1.00
Upstream Filter(I)	1.00	1.00	1.00	1.00	1.00	1.00
Uniform Delay (d), s/veh	17.2	10.7	18.6	20.2	28.8	16.8
Incr Delay (d2), s/veh	14.9	0.0	0.3	1.2	5.5	12.3
Initial Q Delay(d3),s/veh	0.0	0.0	0.0	0.0	0.0	0.0
%ile BackOfQ(50%),veh/ln	11.0	0.1	3.0	4.0	0.6	10.2
Unsig. Movement Delay, s/veh						
LnGrp Delay(d),s/veh	32.1	10.7	18.9	21.4	34.3	29.0
LnGrp LOS	C	B	B	C	C	C
Approach Vol, veh/h	696		631			758
Approach Delay, s/veh	31.7		20.3			29.3
Approach LOS	C		C			C
Timer - Assigned Phs	1	2		4		6
Phs Duration (G+Y+Rc), s	8.2	22.9		29.1		31.1
Change Period (Y+Rc), s	6.2	6.2		4.6		6.2
Max Green Setting (Gmax), s	30.0	30.0		30.0		30.0
Max Q Clear Time (g_c+I), s	14.2	14.2		24.2		23.9
Green Ext Time (p_c), s	0.0	0.6		0.3		1.0

Intersection Summary

HCM 6th Ctrl Delay	27.4
HCM 6th LOS	C

Notes

User approved pedestrian interval to be less than phase max green.

HCM 6th TWSC  
 19: Private Dwy/Paula Ln & Bodega Ave

Cumulative Conditions AM

Intersection												
Int Delay, s/veh	2.2											
Movement	EBL	EBT	EBR	WBL	WBT	WBR	NBL	NBT	NBR	SBL	SBT	SBR
Lane Configurations	↶	↷		↶	↷			↕			↕	
Traffic Vol, veh/h	30	570	0	0	420	30	0	0	0	50	0	30
Future Vol, veh/h	30	570	0	0	420	30	0	0	0	50	0	30
Conflicting Peds, #/hr	0	0	0	0	0	0	0	0	0	0	0	0
Sign Control	Free	Free	Free	Free	Free	Free	Stop	Stop	Stop	Stop	Stop	Stop
RT Channelized	-	-	None	-	-	None	-	-	None	-	-	None
Storage Length	90	-	-	90	-	-	-	-	-	-	-	-
Veh in Median Storage, #	-	0	-	-	0	-	-	0	-	-	0	-
Grade, %	-	0	-	-	0	-	-	0	-	-	0	-
Peak Hour Factor	95	95	95	95	95	95	95	95	95	95	95	95
Heavy Vehicles, %	2	2	2	2	2	2	2	2	2	2	2	2
Mvmt Flow	32	600	0	0	442	32	0	0	0	53	0	32

Major/Minor	Major1			Major2			Minor1			Minor2		
Conflicting Flow All	474	0	0	600	0	0	1138	1138	600	1122	1122	458
Stage 1	-	-	-	-	-	-	664	664	-	458	458	-
Stage 2	-	-	-	-	-	-	474	474	-	664	664	-
Critical Hdwy	4.12	-	-	4.12	-	-	7.12	6.52	6.22	7.12	6.52	6.22
Critical Hdwy Stg 1	-	-	-	-	-	-	6.12	5.52	-	6.12	5.52	-
Critical Hdwy Stg 2	-	-	-	-	-	-	6.12	5.52	-	6.12	5.52	-
Follow-up Hdwy	2.218	-	-	2.218	-	-	3.518	4.018	3.318	3.518	4.018	3.318
Pot Cap-1 Maneuver	1088	-	-	977	-	-	179	201	501	183	206	603
Stage 1	-	-	-	-	-	-	450	458	-	583	567	-
Stage 2	-	-	-	-	-	-	571	558	-	450	458	-
Platoon blocked, %	-	-	-	-	-	-	-	-	-	-	-	-
Mov Cap-1 Maneuver	1088	-	-	977	-	-	166	195	501	179	200	603
Mov Cap-2 Maneuver	-	-	-	-	-	-	166	195	-	179	200	-
Stage 1	-	-	-	-	-	-	437	445	-	566	567	-
Stage 2	-	-	-	-	-	-	541	558	-	437	445	-






















Approach	EB	WB	NB	SB
HCM Control Delay, s	0.4	0	0	27.5
HCM LOS			A	D

Minor Lane/Major Mvmt	NBLn1	EBL	EBT	EBR	WBL	WBT	WBR	SBLn1
Capacity (veh/h)	-	1088	-	-	977	-	-	243
HCM Lane V/C Ratio	-	0.029	-	-	-	-	-	0.347
HCM Control Delay (s)		0	8.4	-	-	0	-	27.5
HCM Lane LOS		A	A	-	-	A	-	D
HCM 95th %tile Q(veh)	-	0.1	-	-	0	-	-	1.5

# HCM 6th Signalized Intersection Summary

## 20: Broadway & Leveroni Rd/Napa Rd

Cumulative Conditions AM

												
Movement	EBL	EBT	EBR	WBL	WBT	WBR	NBL	NBT	NBR	SBL	SBT	SBR
Lane Configurations												
Traffic Volume (veh/h)	340	390	90	80	280	300	80	390	140	230	260	90
Future Volume (veh/h)	340	390	90	80	280	300	80	390	140	230	260	90
Initial Q (Qb), veh	0	0	0	0	0	0	0	0	0	0	0	0
Ped-Bike Adj(A_pbT)	1.00		1.00	1.00		0.99	1.00		0.99	1.00		0.99
Parking Bus, Adj	1.00	1.00	1.00	1.00	1.00	1.00	1.00	1.00	1.00	1.00	1.00	1.00
Work Zone On Approach		No			No			No			No	
Adj Sat Flow, veh/h/ln	1870	1870	1870	1870	1870	1870	1870	1870	1870	1870	1870	1870
Adj Flow Rate, veh/h	358	411	89	84	295	282	84	411	113	242	274	63
Peak Hour Factor	0.95	0.95	0.95	0.95	0.95	0.95	0.95	0.95	0.95	0.95	0.95	0.95
Percent Heavy Veh, %	2	2	2	2	2	2	2	2	2	2	2	2
Cap, veh/h	389	615	133	168	253	242	168	506	138	265	686	155
Arrive On Green	0.22	0.41	0.41	0.09	0.29	0.29	0.09	0.18	0.18	0.15	0.24	0.24
Sat Flow, veh/h	1781	1489	322	1781	877	838	1781	2752	748	1781	2873	649
Grp Volume(v), veh/h	358	0	500	84	0	577	84	264	260	242	168	169
Grp Sat Flow(s),veh/h/ln	1781	0	1811	1781	0	1714	1781	1777	1723	1781	1777	1745
Q Serve(g_s), s	21.1	0.0	24.1	4.8	0.0	31.0	4.8	15.3	15.6	14.4	8.5	8.8
Cycle Q Clear(g_c), s	21.1	0.0	24.1	4.8	0.0	31.0	4.8	15.3	15.6	14.4	8.5	8.8
Prop In Lane	1.00		0.18	1.00		0.49	1.00		0.43	1.00		0.37
Lane Grp Cap(c), veh/h	389	0	748	168	0	495	168	327	317	265	425	417
V/C Ratio(X)	0.92	0.00	0.67	0.50	0.00	1.17	0.50	0.81	0.82	0.91	0.39	0.41
Avail Cap(c_a), veh/h	431	0	748	431	0	495	182	447	433	265	447	439
HCM Platoon Ratio	1.00	1.00	1.00	1.00	1.00	1.00	1.00	1.00	1.00	1.00	1.00	1.00
Upstream Filter(I)	1.00	0.00	1.00	1.00	0.00	1.00	1.00	1.00	1.00	1.00	1.00	1.00
Uniform Delay (d), s/veh	41.1	0.0	25.6	46.3	0.0	38.2	46.3	42.0	42.1	45.0	34.3	34.5
Incr Delay (d2), s/veh	23.7	0.0	2.3	2.3	0.0	94.9	2.3	7.6	8.8	33.0	0.6	0.6
Initial Q Delay(d3),s/veh	0.0	0.0	0.0	0.0	0.0	0.0	0.0	0.0	0.0	0.0	0.0	0.0
%ile BackOfQ(50%),veh/ln	11.4	0.0	10.1	2.2	0.0	25.5	2.2	7.1	7.1	8.7	3.7	3.7
Unsig. Movement Delay, s/veh												
LnGrp Delay(d),s/veh	64.8	0.0	27.9	48.6	0.0	133.1	48.6	49.6	50.9	78.1	34.9	35.1
LnGrp LOS	E	A	C	D	A	F	D	D	D	E	C	D
Approach Vol, veh/h		858			661			608			579	
Approach Delay, s/veh		43.3			122.4			50.0			53.0	
Approach LOS		D			F			D			D	
Timer - Assigned Phs	1	2	3	4	5	6	7	8				
Phs Duration (G+Y+Rc), s	14.1	30.7	27.4	35.2	20.0	24.8	14.1	48.5				
Change Period (Y+Rc), s	4.0	5.0	4.0	* 4.2	4.0	5.0	4.0	* 4.2				
Max Green Setting (Gmax), s	11.0	27.0	26.0	* 31	16.0	27.0	26.0	* 31				
Max Q Clear Time (g_c+I1), s	6.8	10.8	23.1	33.0	16.4	17.6	6.8	26.1				
Green Ext Time (p_c), s	0.1	1.7	0.3	0.0	0.0	2.0	0.2	1.3				
<b>Intersection Summary</b>												
HCM 6th Ctrl Delay			66.2									
HCM 6th LOS			E									
<b>Notes</b>												
* HCM 6th computational engine requires equal clearance times for the phases crossing the barrier.												

HCM 6th AWSC  
 1: Geyserville Ave & Canyon Road

Cumulative Conditions PM

Intersection	
Intersection Delay, s/veh	9.4
Intersection LOS	A

Movement	EBL	EBT	EBR	WBL	WBT	WBR	NBL	NBT	NBR	SBL	SBT	SBR
Lane Configurations		↕			↕			↕			↕	
Traffic Vol, veh/h	50	20	120	20	20	20	170	50	20	20	50	30
Future Vol, veh/h	50	20	120	20	20	20	170	50	20	20	50	30
Peak Hour Factor	0.95	0.95	0.95	0.95	0.95	0.95	0.95	0.95	0.95	0.95	0.95	0.95
Heavy Vehicles, %	2	2	2	2	2	2	2	2	2	2	2	2
Mvmt Flow	53	21	126	21	21	21	179	53	21	21	53	32
Number of Lanes	0	1	0	0	1	0	0	1	0	0	1	0

Approach	EB	WB	NB	SB
Opposing Approach	WB	EB	SB	NB
Opposing Lanes	1	1	1	1
Conflicting Approach Left	SB	NB	EB	WB
Conflicting Lanes Left	1	1	1	1
Conflicting Approach Right	NB	SB	WB	EB
Conflicting Lanes Right	1	1	1	1
HCM Control Delay	9.1	8.4	10.2	8.5
HCM LOS	A	A	B	A

Lane	NBLn1	EBLn1	WBLn1	SBLn1
Vol Left, %	71%	26%	33%	20%
Vol Thru, %	21%	11%	33%	50%
Vol Right, %	8%	63%	33%	30%
Sign Control	Stop	Stop	Stop	Stop
Traffic Vol by Lane	240	190	60	100
LT Vol	170	50	20	20
Through Vol	50	20	20	50
RT Vol	20	120	20	30
Lane Flow Rate	253	200	63	105
Geometry Grp	1	1	1	1
Degree of Util (X)	0.334	0.252	0.086	0.138
Departure Headway (Hd)	4.763	4.544	4.906	4.718
Convergence, Y/N	Yes	Yes	Yes	Yes
Cap	753	788	726	756
Service Time	2.812	2.591	2.966	2.775
HCM Lane V/C Ratio	0.336	0.254	0.087	0.139
HCM Control Delay	10.2	9.1	8.4	8.5
HCM Lane LOS	B	A	A	A
HCM 95th-tile Q	1.5	1	0.3	0.5

# HCM 6th Signalized Intersection Summary

## 2: Armstrong Woods Rd & River Rd

Cumulative Conditions PM



Movement	EBL	EBT	EBR	WBL	WBT	WBR	NBL	NBT	NBR	SBL	SBT	SBR
Lane Configurations												
Traffic Volume (veh/h)	80	540	0	0	650	260	20	50	30	120	0	90
Future Volume (veh/h)	80	540	0	0	650	260	20	50	30	120	0	90
Initial Q (Qb), veh	0	0	0	0	0	0	0	0	0	0	0	0
Ped-Bike Adj(A_pbT)	1.00		1.00	1.00		0.99	0.99		0.99	0.99		0.99
Parking Bus, Adj	1.00	1.00	1.00	1.00	1.00	1.00	1.00	1.00	1.00	1.00	1.00	1.00
Work Zone On Approach		No			No			No			No	
Adj Sat Flow, veh/h/ln	1870	1870	0	0	1870	1870	1870	1870	1870	1870	1870	1870
Adj Flow Rate, veh/h	84	568	0	0	684	183	21	53	12	126	0	14
Peak Hour Factor	0.95	0.95	0.95	0.95	0.95	0.95	0.95	0.95	0.95	0.95	0.95	0.95
Percent Heavy Veh, %	2	2	0	0	2	2	2	2	2	2	2	2
Cap, veh/h	407	1221	0	0	882	744	361	252	57	320	0	268
Arrive On Green	0.09	0.65	0.00	0.00	0.47	0.47	0.17	0.17	0.17	0.17	0.00	0.17
Sat Flow, veh/h	1781	1870	0	0	1870	1577	1380	1471	333	1320	0	1562
Grp Volume(v), veh/h	84	568	0	0	684	183	21	0	65	126	0	14
Grp Sat Flow(s),veh/h/ln	1781	1870	0	0	1870	1577	1380	0	1805	1320	0	1562
Q Serve(g_s), s	1.1	8.1	0.0	0.0	16.3	3.7	0.7	0.0	1.7	4.9	0.0	0.4
Cycle Q Clear(g_c), s	1.1	8.1	0.0	0.0	16.3	3.7	1.1	0.0	1.7	6.5	0.0	0.4
Prop In Lane	1.00		0.00	0.00		1.00	1.00		0.18	1.00		1.00
Lane Grp Cap(c), veh/h	407	1221	0	0	882	744	361	0	309	320	0	268
V/C Ratio(X)	0.21	0.47	0.00	0.00	0.78	0.25	0.06	0.00	0.21	0.39	0.00	0.05
Avail Cap(c_a), veh/h	474	1221	0	0	2517	2122	589	0	607	538	0	525
HCM Platoon Ratio	1.00	1.00	1.00	1.00	1.00	1.00	1.00	1.00	1.00	1.00	1.00	1.00
Upstream Filter(I)	1.00	1.00	0.00	0.00	1.00	1.00	1.00	0.00	1.00	1.00	0.00	1.00
Uniform Delay (d), s/veh	8.0	4.6	0.0	0.0	11.8	8.4	19.0	0.0	19.1	21.9	0.0	18.5
Incr Delay (d2), s/veh	0.2	0.3	0.0	0.0	1.5	0.2	0.1	0.0	0.3	0.8	0.0	0.1
Initial Q Delay(d3),s/veh	0.0	0.0	0.0	0.0	0.0	0.0	0.0	0.0	0.0	0.0	0.0	0.0
%ile BackOfQ(50%),veh/ln	0.3	2.1	0.0	0.0	6.0	1.1	0.2	0.0	0.7	1.5	0.0	0.1
Unsig. Movement Delay, s/veh												
LnGrp Delay(d),s/veh	8.3	4.9	0.0	0.0	13.3	8.6	19.1	0.0	19.4	22.6	0.0	18.6
LnGrp LOS	A	A	A	A	B	A	B	A	B	C	A	B
Approach Vol, veh/h		652			867			86				140
Approach Delay, s/veh		5.3			12.3			19.3				22.2
Approach LOS		A			B			B				C
Timer - Assigned Phs		2		4	5	6		8				
Phs Duration (G+Y+Rc), s		39.6		13.9	9.7	29.9		13.9				
Change Period (Y+Rc), s		* 4.7		* 4.7	* 4.7	* 4.7		* 4.7				
Max Green Setting (Gmax), s		* 32		* 18	* 7	* 72		* 18				
Max Q Clear Time (g_c+I1), s		10.1		8.5	3.1	18.3		3.7				
Green Ext Time (p_c), s		4.1		0.3	0.1	7.0		0.3				

### Intersection Summary

HCM 6th Ctrl Delay	10.8
HCM 6th LOS	B

### Notes

- User approved pedestrian interval to be less than phase max green.
- \* HCM 6th computational engine requires equal clearance times for the phases crossing the barrier.



# HCM 6th Signalized Intersection Summary

## 3: Gravenstein Hwy/Old River Rd & River Rd

Cumulative Conditions PM



Movement	EBL	EBT	EBR	WBL	WBT	WBR	NBL	NBT	NBR	SBL	SBT	SBR
Lane Configurations		↑	↗	↖	↗	↖	↗	↖			↕	
Traffic Volume (veh/h)	0	500	190	90	630	30	230	20	50	30	30	50
Future Volume (veh/h)	0	500	190	90	630	30	230	20	50	30	30	50
Initial Q (Qb), veh	0	0	0	0	0	0	0	0	0	0	0	0
Ped-Bike Adj(A_pbT)	1.00		0.99	1.00		1.00	0.99		1.00	1.00		0.99
Parking Bus, Adj	1.00	1.00	1.00	1.00	1.00	1.00	1.00	1.00	1.00	1.00	1.00	1.00
Work Zone On Approach		No		No		No		No		No		No
Adj Sat Flow, veh/h/ln	0	1870	1870	1870	1870	1870	1870	1870	1870	1870	1870	1870
Adj Flow Rate, veh/h	0	526	141	95	663	30	242	21	13	32	32	13
Peak Hour Factor	0.95	0.95	0.95	0.95	0.95	0.95	0.95	0.95	0.95	0.95	0.95	0.95
Percent Heavy Veh, %	0	2	2	2	2	2	2	2	2	2	2	2
Cap, veh/h	0	667	561	469	1044	47	456	234	145	212	189	60
Arrive On Green	0.00	0.36	0.36	0.13	0.59	0.59	0.22	0.22	0.22	0.22	0.22	0.22
Sat Flow, veh/h	0	1870	1574	1781	1775	80	1348	1081	669	491	872	277
Grp Volume(v), veh/h	0	526	141	95	0	693	242	0	34	77	0	0
Grp Sat Flow(s),veh/h/ln	0	1870	1574	1781	0	1855	1348	0	1750	1640	0	0
Q Serve(g_s), s	0.0	12.1	3.1	1.3	0.0	11.8	6.0	0.0	0.7	0.0	0.0	0.0
Cycle Q Clear(g_c), s	0.0	12.1	3.1	1.3	0.0	11.8	7.6	0.0	0.7	1.7	0.0	0.0
Prop In Lane	0.00		1.00	1.00		0.04	1.00		0.38	0.42		0.17
Lane Grp Cap(c), veh/h	0	667	561	469	0	1092	456	0	379	461	0	0
V/C Ratio(X)	0.00	0.79	0.25	0.20	0.00	0.63	0.53	0.00	0.09	0.17	0.00	0.00
Avail Cap(c_a), veh/h	0	931	784	562	0	1092	1003	0	1089	461	0	0
HCM Platoon Ratio	1.00	1.00	1.00	1.00	1.00	1.00	1.00	1.00	1.00	1.00	1.00	1.00
Upstream Filter(I)	0.00	1.00	1.00	1.00	0.00	1.00	1.00	0.00	1.00	1.00	0.00	0.00
Uniform Delay (d), s/veh	0.0	13.9	11.0	7.9	0.0	6.5	17.6	0.0	15.1	15.4	0.0	0.0
Incr Delay (d2), s/veh	0.0	3.1	0.2	0.2	0.0	1.2	1.0	0.0	0.1	0.2	0.0	0.0
Initial Q Delay(d3),s/veh	0.0	0.0	0.0	0.0	0.0	0.0	0.0	0.0	0.0	0.0	0.0	0.0
%ile BackOfQ(50%),veh/ln	0.0	4.9	1.0	0.4	0.0	3.5	2.4	0.0	0.3	0.7	0.0	0.0
Unsig. Movement Delay, s/veh												
LnGrp Delay(d),s/veh	0.0	17.0	11.2	8.1	0.0	7.7	18.6	0.0	15.2	15.6	0.0	0.0
LnGrp LOS	A	B	B	A	A	A	B	A	B	B	A	A
Approach Vol, veh/h		667			788			276				77
Approach Delay, s/veh		15.8			7.8			18.1				15.6
Approach LOS		B			A			B				B
Timer - Assigned Phs	1	2		4		6		8				
Phs Duration (G+Y+Rc), s	1.2	21.9		15.1		33.1		15.1				
Change Period (Y+Rc), s	4.7	* 4.7		* 4.7		* 4.7		* 4.7				
Max Green Setting (Gmax), s	9	* 24		* 10		* 24		* 30				
Max Q Clear Time (g_c+1), s	13	14.1		3.7		13.8		9.6				
Green Ext Time (p_c), s	0.1	2.9		0.1		3.6		0.9				

### Intersection Summary

HCM 6th Ctrl Delay	12.6
HCM 6th LOS	B

### Notes

- User approved pedestrian interval to be less than phase max green.
- \* HCM 6th computational engine requires equal clearance times for the phases crossing the barrier.

HCM 6th TWSC  
 4: Old Redwood Hwy & Fulton Rd

Cumulative Conditions PM

Intersection						
Int Delay, s/veh	267.2					
Movement	EBL	EBR	NBL	NBT	SBT	SBR
Lane Configurations						
Traffic Vol, veh/h	400	80	60	800	640	320
Future Vol, veh/h	400	80	60	800	640	320
Conflicting Peds, #/hr	0	0	0	0	0	0
Sign Control	Stop	Stop	Free	Free	Free	Free
RT Channelized	-	Stop	-	None	-	None
Storage Length	0	90	70	-	-	100
Veh in Median Storage, #	0	-	-	0	0	-
Grade, %	0	-	-	0	0	-
Peak Hour Factor	95	95	95	95	95	95
Heavy Vehicles, %	2	2	2	2	2	2
Mvmt Flow	421	84	63	842	674	337

Major/Minor	Minor2	Major1	Major2			
Conflicting Flow All	1642	674	1011	0	-	0
Stage 1	674	-	-	-	-	-
Stage 2	968	-	-	-	-	-
Critical Hdwy	6.42	6.22	4.12	-	-	-
Critical Hdwy Stg 1	5.42	-	-	-	-	-
Critical Hdwy Stg 2	5.42	-	-	-	-	-
Follow-up Hdwy	3.518	3.318	2.218	-	-	-
Pot Cap-1 Maneuver	~ 110	455	686	-	-	-
Stage 1	506	-	-	-	-	-
Stage 2	~ 368	-	-	-	-	-
Platoon blocked, %				-	-	-
Mov Cap-1 Maneuver	~ 100	455	686	-	-	-
Mov Cap-2 Maneuver	~ 100	-	-	-	-	-
Stage 1	459	-	-	-	-	-
Stage 2	~ 368	-	-	-	-	-























Approach	EB	NB	SB
HCM Control Delay, \$	1278.7	0.8	0
HCM LOS	F		

Minor Lane/Major Mvmt	NBL	NBT	EBLn1	EBLn2	SBT	SBR
Capacity (veh/h)	686	-	100	455	-	-
HCM Lane V/C Ratio	0.092	-	4.211	0.185	-	-
HCM Control Delay (s)	10.8	\$	1531.5	14.7	-	-
HCM Lane LOS	B	-	F	B	-	-
HCM 95th %tile Q(veh)	0.3	-	43.7	0.7	-	-

Notes  
 -: Volume exceeds capacity    \$: Delay exceeds 300s    +: Computation Not Defined    \*: All major volume in platoon

HCM 6th Signalized Intersection Summary  
5: Fulton Rd & Airport Blvd

Cumulative Conditions PM

												
Movement	EBL	EBT	EBR	WBL	WBT	WBR	NBL	NBT	NBR	SBL	SBT	SBR
Lane Configurations												
Traffic Volume (veh/h)	220	880	700	170	440	50	610	390	220	60	320	150
Future Volume (veh/h)	220	880	700	170	440	50	610	390	220	60	320	150
Initial Q (Qb), veh	0	0	0	0	0	0	0	0	0	0	0	0
Ped-Bike Adj(A_pbT)	1.00		0.99	1.00		0.99	1.00		0.99	1.00		0.99
Parking Bus, Adj	1.00	1.00	1.00	1.00	1.00	1.00	1.00	1.00	1.00	1.00	1.00	1.00
Work Zone On Approach		No			No			No			No	
Adj Sat Flow, veh/h/ln	1870	1870	1870	1870	1870	1870	1870	1870	1870	1870	1870	1870
Adj Flow Rate, veh/h	232	926	482	179	463	50	642	411	47	63	337	146
Peak Hour Factor	0.95	0.95	0.95	0.95	0.95	0.95	0.95	0.95	0.95	0.95	0.95	0.95
Percent Heavy Veh, %	2	2	2	2	2	2	2	2	2	2	2	2
Cap, veh/h	257	575	483	205	461	50	424	446	374	32	174	75
Arrive On Green	0.14	0.31	0.31	0.12	0.28	0.28	0.24	0.24	0.24	0.16	0.16	0.16
Sat Flow, veh/h	1781	1870	1572	1781	1657	179	1781	1870	1568	204	1092	473
Grp Volume(v), veh/h	232	926	482	179	0	513	642	411	47	546	0	0
Grp Sat Flow(s),veh/h/ln	1781	1870	1572	1781	0	1836	1781	1870	1568	1770	0	0
Q Serve(g_s), s	16.1	38.7	38.6	12.4	0.0	35.0	30.0	27.0	3.0	20.0	0.0	0.0
Cycle Q Clear(g_c), s	16.1	38.7	38.6	12.4	0.0	35.0	30.0	27.0	3.0	20.0	0.0	0.0
Prop In Lane	1.00		1.00	1.00		0.10	1.00		1.00	0.12		0.27
Lane Grp Cap(c), veh/h	257	575	483	205	0	511	424	446	374	281	0	0
V/C Ratio(X)	0.90	1.61	1.00	0.87	0.00	1.00	1.51	0.92	0.13	1.94	0.00	0.00
Avail Cap(c_a), veh/h	283	575	483	277	0	511	424	446	374	281	0	0
HCM Platoon Ratio	1.00	1.00	1.00	1.00	1.00	1.00	1.00	1.00	1.00	1.00	1.00	1.00
Upstream Filter(I)	1.00	1.00	1.00	1.00	0.00	1.00	1.00	1.00	1.00	1.00	0.00	0.00
Uniform Delay (d), s/veh	53.0	43.6	43.6	54.8	0.0	45.4	47.9	46.8	37.6	52.9	0.0	0.0
Incr Delay (d2), s/veh	26.7	283.3	40.4	16.1	0.0	41.0	242.5	24.2	0.1	436.7	0.0	0.0
Initial Q Delay(d3),s/veh	0.0	0.0	0.0	0.0	0.0	0.0	0.0	0.0	0.0	0.0	0.0	0.0
%ile BackOfQ(50%),veh/ln	8.9	62.4	19.8	6.4	0.0	21.3	41.4	15.2	1.1	42.9	0.0	0.0
Unsig. Movement Delay, s/veh												
LnGrp Delay(d),s/veh	79.7	326.9	84.0	70.9	0.0	86.5	290.4	71.0	37.7	489.7	0.0	0.0
LnGrp LOS	E	F	F	E	A	F	F	E	D	F	A	A
Approach Vol, veh/h		1640			692			1100			546	
Approach Delay, s/veh		220.5			82.5			197.6			489.7	
Approach LOS		F			F			F			F	
Timer - Assigned Phs	1	2		4	5	6		8				
Phs Duration (G+Y+Rc), s	20.3	44.7		25.1	24.0	41.0		35.8				
Change Period (Y+Rc), s	5.8	6.0		5.1	5.8	6.0		5.8				
Max Green Setting (Gmax), s	19.6	30.0		20.0	20.0	35.0		30.0				
Max Q Clear Time (g_c+I1), s	14.4	40.7		22.0	18.1	37.0		32.0				
Green Ext Time (p_c), s	0.1	0.0		0.0	0.1	0.0		0.0				

Intersection Summary

HCM 6th Ctrl Delay	227.1
HCM 6th LOS	F

Notes

User approved pedestrian interval to be less than phase max green.

# HCM 6th Signalized Intersection Summary

## 6: Old Redwood Hwy & Airport Blvd

Cumulative Conditions PM



Movement	EBL	EBT	EBR	WBL	WBT	WBR	NBL	NBT	NBR	SBL	SBT	SBR
Lane Configurations												
Traffic Volume (veh/h)	100	230	560	30	130	50	340	750	30	70	560	70
Future Volume (veh/h)	100	230	560	30	130	50	340	750	30	70	560	70
Initial Q (Qb), veh	0	0	0	0	0	0	0	0	0	0	0	0
Ped-Bike Adj(A_pbT)	1.00		1.00	1.00		1.00	1.00		1.00	1.00		1.00
Parking Bus, Adj	1.00	1.00	1.00	1.00	1.00	1.00	1.00	1.00	1.00	1.00	1.00	1.00
Work Zone On Approach		No			No			No			No	
Adj Sat Flow, veh/h/ln	1870	1870	1870	1870	1870	1870	1870	1870	1870	1870	1870	1870
Adj Flow Rate, veh/h	105	242	212	32	137	38	358	789	14	74	589	21
Peak Hour Factor	0.95	0.95	0.95	0.95	0.95	0.95	0.95	0.95	0.95	0.95	0.95	0.95
Percent Heavy Veh, %	2	2	2	2	2	2	2	2	2	2	2	2
Cap, veh/h	133	336	285	45	170	47	392	938	795	95	626	530
Arrive On Green	0.07	0.18	0.18	0.03	0.12	0.12	0.22	0.50	0.50	0.05	0.33	0.33
Sat Flow, veh/h	1781	1870	1585	1781	1409	391	1781	1870	1585	1781	1870	1585
Grp Volume(v), veh/h	105	242	212	32	0	175	358	789	14	74	589	21
Grp Sat Flow(s),veh/h/ln	1781	1870	1585	1781	0	1800	1781	1870	1585	1781	1870	1585
Q Serve(g_s), s	4.9	10.2	10.6	1.5	0.0	8.0	16.5	30.6	0.4	3.4	25.7	0.8
Cycle Q Clear(g_c), s	4.9	10.2	10.6	1.5	0.0	8.0	16.5	30.6	0.4	3.4	25.7	0.8
Prop In Lane	1.00		1.00	1.00		0.22	1.00		1.00	1.00		1.00
Lane Grp Cap(c), veh/h	133	336	285	45	0	217	392	938	795	95	626	530
V/C Ratio(X)	0.79	0.72	0.74	0.72	0.00	0.81	0.91	0.84	0.02	0.78	0.94	0.04
Avail Cap(c_a), veh/h	254	890	754	254	0	557	424	938	795	212	668	566
HCM Platoon Ratio	1.00	1.00	1.00	1.00	1.00	1.00	1.00	1.00	1.00	1.00	1.00	1.00
Upstream Filter(I)	1.00	1.00	1.00	1.00	0.00	1.00	1.00	1.00	1.00	1.00	1.00	1.00
Uniform Delay (d), s/veh	38.2	32.5	32.6	40.7	0.0	36.0	32.0	18.1	10.5	39.3	27.2	18.9
Incr Delay (d2), s/veh	3.8	1.1	1.5	7.7	0.0	2.7	21.9	6.6	0.0	5.1	20.4	0.0
Initial Q Delay(d3),s/veh	0.0	0.0	0.0	0.0	0.0	0.0	0.0	0.0	0.0	0.0	0.0	0.0
%ile BackOfQ(50%),veh/ln	2.2	4.5	4.0	0.8	0.0	3.6	9.1	13.4	0.1	1.6	14.2	0.3
Unsig. Movement Delay, s/veh												
LnGrp Delay(d),s/veh	42.1	33.6	34.1	48.4	0.0	38.7	53.8	24.7	10.5	44.3	47.6	18.9
LnGrp LOS	D	C	C	D	A	D	D	C	B	D	D	B
Approach Vol, veh/h		559			207			1161			684	
Approach Delay, s/veh		35.4			40.2			33.5			46.3	
Approach LOS		D			D			C			D	
Timer - Assigned Phs	1	2	3	4	5	6	7	8				
Phs Duration (G+Y+Rc), s	6.7	20.5	23.6	33.2	11.7	15.5	9.6	47.2				
Change Period (Y+Rc), s	4.6	5.4	5.1	5.1	5.4	* 5.4	5.1	5.1				
Max Green Setting (Gmax), s	12.0	40.0	20.0	30.0	12.0	* 26	10.0	30.0				
Max Q Clear Time (g_c+1), s	11.5	12.6	18.5	27.7	6.9	10.0	5.4	32.6				
Green Ext Time (p_c), s	0.0	0.5	0.0	0.4	0.0	0.3	0.0	0.0				

### Intersection Summary

HCM 6th Ctrl Delay	37.8
HCM 6th LOS	D

### Notes

User approved pedestrian interval to be less than phase max green.  
 \* HCM 6th computational engine requires equal clearance times for the phases crossing the barrier.

HCM 6th TWSC

7: Old Redwood Hwy & Creekside Apts/Faught Rd

Cumulative Conditions PM

Intersection												
Int Delay, s/veh	687.6											
Movement	EBL	EBT	EBR	WBL	WBT	WBR	NBL	NBT	NBR	SBL	SBT	SBR
Lane Configurations		↕			↕		↑	↑	↑		↕	
Traffic Vol, veh/h	20	20	30	100	20	60	30	920	170	50	990	50
Future Vol, veh/h	20	20	30	100	20	60	30	920	170	50	990	50
Conflicting Peds, #/hr	0	0	0	0	0	0	0	0	0	0	0	0
Sign Control	Stop	Stop	Stop	Stop	Stop	Stop	Free	Free	Free	Free	Free	Free
RT Channelized	-	-	None	-	-	None	-	-	None	-	-	None
Storage Length	-	-	-	-	-	-	50	-	270	-	-	-
Veh in Median Storage, #	-	0	-	-	0	-	-	0	-	-	0	-
Grade, %	-	0	-	-	0	-	-	0	-	-	0	-
Peak Hour Factor	95	95	95	95	95	95	95	95	95	95	95	95
Heavy Vehicles, %	2	2	2	2	2	2	2	2	2	2	2	2
Mvmt Flow	21	21	32	105	21	63	32	968	179	53	1042	53

Major/Minor	Minor2		Minor1		Major1		Major2					
Conflicting Flow All	2339	2386	1069	2233	2233	968	1095	0	0	1147	0	0
Stage 1	1175	1175	-	1032	1032	-	-	-	-	-	-	-
Stage 2	1164	1211	-	1201	1201	-	-	-	-	-	-	-
Critical Hdwy	7.12	6.52	6.22	7.12	6.52	6.22	4.12	-	-	4.12	-	-
Critical Hdwy Stg 1	6.12	5.52	-	6.12	5.52	-	-	-	-	-	-	-
Critical Hdwy Stg 2	6.12	5.52	-	6.12	5.52	-	-	-	-	-	-	-
Follow-up Hdwy	3.518	4.018	3.318	3.518	4.018	3.318	2.218	-	-	2.218	-	-
Pot Cap-1 Maneuver	26	34	269	~ 30	43	308	637	-	-	609	-	-
Stage 1	233	265	-	281	310	-	-	-	-	-	-	-
Stage 2	237	255	-	226	258	-	-	-	-	-	-	-
Platoon blocked, %								-	-	-	-	-
Mov Cap-1 Maneuver	~ 8	25	269	~ 6	32	308	637	-	-	609	-	-
Mov Cap-2 Maneuver	~ 8	25	-	~ 6	32	-	-	-	-	-	-	-
Stage 1	221	205	-	267	295	-	-	-	-	-	-	-
Stage 2	166	242	-	139	200	-	-	-	-	-	-	-






















Approach	EB		WB		NB		SB	
HCM Control Delay, \$	1508.6		8805		0.3		0.5	
HCM LOS	F		F					

Minor Lane/Major Mvmt	NBL	NBT	NBR	EBLn1	WBLn1	SBL	SBT	SBR
Capacity (veh/h)	637	-	-	21	10	609	-	-
HCM Lane V/C Ratio	0.05	-	-	3.509	18.947	0.086	-	-
HCM Control Delay (s)	10.9	-	-	\$ 1508.6	\$ 8805	11.5	0	-
HCM Lane LOS	B	-	-	F	F	B	A	-
HCM 95th %tile Q(veh)	0.2	-	-	9.5	25.2	0.3	-	-

Notes  
 -: Volume exceeds capacity    \$: Delay exceeds 300s    +: Computation Not Defined    \*: All major volume in platoon

HCM 6th Signalized Intersection Summary  
 8: Old Redwood Hwy & Mark West Commons Cir/Wikiup Dr

Cumulative Conditions PM

												
Movement	EBL	EBT	EBR	WBL	WBT	WBR	NBL	NBT	NBR	SBL	SBT	SBR
Lane Configurations												
Traffic Volume (veh/h)	20	20	20	190	20	150	40	890	190	100	920	20
Future Volume (veh/h)	20	20	20	190	20	150	40	890	190	100	920	20
Initial Q (Qb), veh	0	0	0	0	0	0	0	0	0	0	0	0
Ped-Bike Adj(A_pbT)	1.00		0.99	0.99		0.99	1.00		0.99	1.00		0.99
Parking Bus, Adj	1.00	1.00	1.00	1.00	1.00	1.00	1.00	1.00	1.00	1.00	1.00	1.00
Work Zone On Approach		No			No			No			No	
Adj Sat Flow, veh/h/ln	1870	1870	1870	1870	1870	1870	1870	1870	1870	1870	1870	1870
Adj Flow Rate, veh/h	21	21	4	200	21	62	42	937	132	105	968	10
Peak Hour Factor	0.95	0.95	0.95	0.95	0.95	0.95	0.95	0.95	0.95	0.95	0.95	0.95
Percent Heavy Veh, %	2	2	2	2	2	2	2	2	2	2	2	2
Cap, veh/h	108	89	11	345	26	411	57	830	699	135	911	768
Arrive On Green	0.26	0.26	0.26	0.26	0.26	0.26	0.03	0.44	0.44	0.08	0.49	0.49
Sat Flow, veh/h	115	340	43	932	98	1570	1781	1870	1576	1781	1870	1577
Grp Volume(v), veh/h	46	0	0	221	0	62	42	937	132	105	968	10
Grp Sat Flow(s),veh/h/ln	499	0	0	1030	0	1570	1781	1870	1576	1781	1870	1577
Q Serve(g_s), s	0.4	0.0	0.0	0.0	0.0	2.1	1.6	30.0	3.4	3.9	32.9	0.2
Cycle Q Clear(g_c), s	15.2	0.0	0.0	14.8	0.0	2.1	1.6	30.0	3.4	3.9	32.9	0.2
Prop In Lane	0.46		0.09	0.90		1.00	1.00		1.00	1.00		1.00
Lane Grp Cap(c), veh/h	208	0	0	371	0	411	57	830	699	135	911	768
V/C Ratio(X)	0.22	0.00	0.00	0.60	0.00	0.15	0.73	1.13	0.19	0.78	1.06	0.01
Avail Cap(c_a), veh/h	208	0	0	524	0	580	316	830	699	316	911	768
HCM Platoon Ratio	1.00	1.00	1.00	1.00	1.00	1.00	1.00	1.00	1.00	1.00	1.00	1.00
Upstream Filter(I)	1.00	0.00	0.00	1.00	0.00	1.00	1.00	1.00	1.00	1.00	1.00	1.00
Uniform Delay (d), s/veh	20.1	0.0	0.0	23.9	0.0	19.2	32.4	18.8	11.4	30.7	17.3	9.0
Incr Delay (d2), s/veh	0.2	0.0	0.0	0.6	0.0	0.1	6.4	73.2	0.0	3.6	47.9	0.0
Initial Q Delay(d3),s/veh	0.0	0.0	0.0	0.0	0.0	0.0	0.0	0.0	0.0	0.0	0.0	0.0
%ile BackOfQ(50%),veh/ln	0.5	0.0	0.0	3.3	0.0	0.7	0.8	27.8	1.1	1.7	23.7	0.1
Unsig. Movement Delay, s/veh												
LnGrp Delay(d),s/veh	20.3	0.0	0.0	24.5	0.0	19.2	38.9	92.0	11.5	34.3	65.2	9.0
LnGrp LOS	C	A	A	C	A	B	D	F	B	C	F	A
Approach Vol, veh/h		46			283			1111			1083	
Approach Delay, s/veh		20.3			23.3			80.4			61.7	
Approach LOS		C			C			F			E	
Timer - Assigned Phs		2	3	4		6	7	8				
Phs Duration (G+Y+Rc), s		22.3	7.3	38.0		22.3	10.2	35.1				
Change Period (Y+Rc), s		4.6	5.1	5.1		4.6	5.1	5.1				
Max Green Setting (Gmax), s		12.0	12.0	30.0		25.0	12.0	30.0				
Max Q Clear Time (g_c+I1), s		17.2	3.6	34.9		16.8	5.9	32.0				
Green Ext Time (p_c), s		0.0	0.0	0.0		0.6	0.0	0.0				
<b>Intersection Summary</b>												
HCM 6th Ctrl Delay				64.9								
HCM 6th LOS				E								
<b>Notes</b>												
User approved pedestrian interval to be less than phase max green.												

**Intersection**

Int Delay, s/veh 18.7

Movement	EBL	EBT	WBT	WBR	SBL	SBR
Lane Configurations		↕	↑	↗	↖	↗
Traffic Vol, veh/h	50	270	270	610	380	80
Future Vol, veh/h	50	270	270	610	380	80
Conflicting Peds, #/hr	0	0	0	0	0	0
Sign Control	Free	Free	Free	Free	Stop	Stop
RT Channelized	-	None	-	Yield	-	None
Storage Length	-	-	-	150	90	0
Veh in Median Storage, #	-	0	0	-	0	-
Grade, %	-	0	0	-	0	-
Peak Hour Factor	95	95	95	95	95	95
Heavy Vehicles, %	2	2	2	2	2	2
Mvmt Flow	53	284	284	642	400	84

**Major/Minor**

	Major1	Major2	Minor2		
Conflicting Flow All	284	0	0	674	284
Stage 1	-	-	-	284	-
Stage 2	-	-	-	390	-
Critical Hdwy	4.12	-	-	6.42	6.22
Critical Hdwy Stg 1	-	-	-	5.42	-
Critical Hdwy Stg 2	-	-	-	5.42	-
Follow-up Hdwy	2.218	-	-	3.518	3.318
Pot Cap-1 Maneuver	1278	-	-	420	755
Stage 1	-	-	-	764	-
Stage 2	-	-	-	684	-
Platoon blocked, %	-	-	-	-	-
Mov Cap-1 Maneuver	1278	-	-	~ 399	755
Mov Cap-2 Maneuver	-	-	-	~ 399	-
Stage 1	-	-	-	727	-
Stage 2	-	-	-	684	-

**Approach**

	EB	WB	SB
HCM Control Delay, s	1.2	0	66.6
HCM LOS			F

**Minor Lane/Major Mvmt**




















	EBL	EBT	WBT	WBR	SBLn1	SBLn2
Capacity (veh/h)	1278	-	-	-	399	755
HCM Lane V/C Ratio	0.041	-	-	-	1.003	0.112
HCM Control Delay (s)	7.9	0	-	-	78.4	10.4
HCM Lane LOS	A	A	-	-	F	B
HCM 95th %tile Q(veh)	0.1	-	-	-	12.3	0.4

**Notes**

-: Volume exceeds capacity    \$: Delay exceeds 300s    +: Computation Not Defined    \*: All major volume in platoon

HCM 6th Signalized Intersection Summary  
 10: Gravenstein Hwy & Graton Rd/Frei Rd

Cumulative Conditions PM

												
Movement	EBL	EBT	EBR	WBL	WBT	WBR	NBL	NBT	NBR	SBL	SBT	SBR
Lane Configurations												
Traffic Volume (veh/h)	40	40	130	240	70	20	160	630	110	20	570	50
Future Volume (veh/h)	40	40	130	240	70	20	160	630	110	20	570	50
Initial Q (Qb), veh	0	0	0	0	0	0	0	0	0	0	0	0
Ped-Bike Adj(A_pbT)	1.00		0.99	0.99		0.99	1.00		0.99	1.00		0.99
Parking Bus, Adj	1.00	1.00	1.00	1.00	1.00	1.00	1.00	1.00	1.00	1.00	1.00	1.00
Work Zone On Approach		No			No			No			No	
Adj Sat Flow, veh/h/ln	1870	1870	1870	1870	1870	1870	1870	1870	1870	1870	1870	1870
Adj Flow Rate, veh/h	42	42	22	253	74	19	168	663	114	21	600	51
Peak Hour Factor	0.95	0.95	0.95	0.95	0.95	0.95	0.95	0.95	0.95	0.95	0.95	0.95
Percent Heavy Veh, %	2	2	2	2	2	2	2	2	2	2	2	2
Cap, veh/h	236	212	359	289	58	15	294	755	130	102	643	55
Arrive On Green	0.23	0.23	0.23	0.23	0.23	0.23	0.17	0.49	0.49	0.06	0.38	0.38
Sat Flow, veh/h	694	927	1568	871	255	65	1781	1554	267	1781	1699	144
Grp Volume(v), veh/h	84	0	22	346	0	0	168	0	777	21	0	651
Grp Sat Flow(s),veh/h/ln	1621	0	1568	1191	0	0	1781	0	1821	1781	0	1843
Q Serve(g_s), s	0.0	0.0	0.8	13.4	0.0	0.0	6.1	0.0	26.7	0.8	0.0	23.7
Cycle Q Clear(g_c), s	2.6	0.0	0.8	16.0	0.0	0.0	6.1	0.0	26.7	0.8	0.0	23.7
Prop In Lane	0.50		1.00	0.73		0.05	1.00		0.15	1.00		0.08
Lane Grp Cap(c), veh/h	448	0	359	362	0	0	294	0	885	102	0	698
V/C Ratio(X)	0.19	0.00	0.06	0.96	0.00	0.00	0.57	0.00	0.88	0.21	0.00	0.93
Avail Cap(c_a), veh/h	1195	0	1121	362	0	0	408	0	1302	1274	0	698
HCM Platoon Ratio	1.00	1.00	1.00	1.00	1.00	1.00	1.00	1.00	1.00	1.00	1.00	1.00
Upstream Filter(I)	1.00	0.00	1.00	1.00	0.00	0.00	1.00	0.00	1.00	1.00	0.00	1.00
Uniform Delay (d), s/veh	21.8	0.0	21.1	29.7	0.0	0.0	26.9	0.0	16.1	31.4	0.0	20.9
Incr Delay (d2), s/veh	0.2	0.0	0.1	35.9	0.0	0.0	1.7	0.0	4.9	1.0	0.0	19.5
Initial Q Delay(d3),s/veh	0.0	0.0	0.0	0.0	0.0	0.0	0.0	0.0	0.0	0.0	0.0	0.0
%ile BackOfQ(50%),veh/ln	1.1	0.0	0.3	9.2	0.0	0.0	2.5	0.0	9.9	0.3	0.0	12.3
Unsig. Movement Delay, s/veh												
LnGrp Delay(d),s/veh	22.0	0.0	21.1	65.6	0.0	0.0	28.6	0.0	21.0	32.4	0.0	40.4
LnGrp LOS	C	A	C	E	A	A	C	A	C	C	A	D
Approach Vol, veh/h		106			346			945			672	
Approach Delay, s/veh		21.8			65.6			22.4			40.1	
Approach LOS		C			E			C			D	
Timer - Assigned Phs	1	2		4	5	6		8				
Phs Duration (G+Y+Rc), s	16.2	32.3		21.4	8.7	39.8		21.4				
Change Period (Y+Rc), s	* 4.7	5.8		5.4	* 4.7	5.8		5.4				
Max Green Setting (Gmax), s	* 16	25.0		16.0	* 50	50.0		50.0				
Max Q Clear Time (g_c+I1), s	8.1	25.7		18.0	2.8	28.7		4.6				
Green Ext Time (p_c), s	0.2	0.0		0.0	0.0	5.2		0.5				
<b>Intersection Summary</b>												
HCM 6th Ctrl Delay			35.3									
HCM 6th LOS			D									
<b>Notes</b>												
User approved pedestrian interval to be less than phase max green.												
* HCM 6th computational engine requires equal clearance times for the phases crossing the barrier.												



HCM 6th TWSC  
 11: Private Dwy/Moorland Ave & Todd Rd

Cumulative Conditions PM

Intersection

Int Delay, s/veh 1721.4

Movement	EBL	EBT	EBR	WBL	WBT	WBR	NBL	NBT	NBR	SBL	SBT	SBR
Lane Configurations	↖	↗		↖	↗			↕			↖	↗
Traffic Vol, veh/h	70	680	20	30	550	450	20	30	30	470	30	40
Future Vol, veh/h	70	680	20	30	550	450	20	30	30	470	30	40
Conflicting Peds, #/hr	0	0	0	0	0	0	0	0	0	0	0	0
Sign Control	Free	Free	Free	Free	Free	Free	Stop	Stop	Stop	Stop	Stop	Stop
RT Channelized	-	-	None	-	-	None	-	-	None	-	-	None
Storage Length	100	-	-	70	-	-	-	-	-	-	-	60
Veh in Median Storage, #	-	0	-	-	0	-	-	0	-	-	0	-
Grade, %	-	0	-	-	0	-	-	0	-	-	0	-
Peak Hour Factor	95	95	95	95	95	95	95	95	95	95	95	95
Heavy Vehicles, %	2	2	2	2	2	2	2	2	2	2	2	2
Mvmt Flow	74	716	21	32	579	474	21	32	32	495	32	42

Major/Minor	Major1	Major2	Minor1	Minor2
Conflicting Flow All	1053	0	0	737
Stage 1	-	-	-	-
Stage 2	-	-	-	-
Critical Hdwy	4.12	-	-	4.12
Critical Hdwy Stg 1	-	-	-	-
Critical Hdwy Stg 2	-	-	-	-
Follow-up Hdwy	2.218	-	-	2.218
Pot Cap-1 Maneuver	661	-	-	869
Stage 1	-	-	-	-
Stage 2	-	-	-	-
Platoon blocked, %	-	-	-	-
Mov Cap-1 Maneuver	661	-	-	869
Mov Cap-2 Maneuver	-	-	-	-
Stage 1	-	-	-	-
Stage 2	-	-	-	-

Approach	EB	WB	NB	SB
HCM Control Delay, s	1	0.3	\$ 328.1	\$ 7663.9
HCM LOS			F	F





















Minor Lane/Major Mvmt	NBLn1	EBL	EBT	EBR	WBL	WBT	WBR	SBLn1	SBLn2
Capacity (veh/h)	64	661	-	-	869	-	-	28	377
HCM Lane V/C Ratio	1.316	0.111	-	-	0.036	-	-	18.797	0.112
HCM Control Delay (s)	\$ 328.1	11.1	-	-	9.3	-	-	\$ 8275.8	15.7
HCM Lane LOS	F	B	-	-	A	-	-	F	C
HCM 95th %tile Q(veh)	7	0.4	-	-	0.1	-	-	65.3	0.4

Notes  
 -: Volume exceeds capacity    \$: Delay exceeds 300s    +: Computation Not Defined    \*: All major volume in platoon

# HCM 6th Signalized Intersection Summary

## 12: S Moreland Ave & Todd Rd

Cumulative Conditions PM

												
Movement	EBL	EBT	EBR	WBL	WBT	WBR	NBL	NBT	NBR	SBL	SBT	SBR
Lane Configurations												
Traffic Volume (veh/h)	0	510	670	430	390	0	640	0	190	0	0	0
Future Volume (veh/h)	0	510	670	430	390	0	640	0	190	0	0	0
Initial Q (Qb), veh	0	0	0	0	0	0	0	0	0	0	0	0
Ped-Bike Adj(A_pbT)	1.00		1.00	1.00		1.00	1.00		1.00	1.00		1.00
Parking Bus, Adj	1.00	1.00	1.00	1.00	1.00	1.00	1.00	1.00	1.00	1.00	1.00	1.00
Work Zone On Approach		No			No			No			No	
Adj Sat Flow, veh/h/ln	1870	1870	1870	1870	1870	1870	1870	1870	1870	1870	1870	1870
Adj Flow Rate, veh/h	0	537	407	453	411	0	674	0	127	0	0	0
Peak Hour Factor	0.95	0.95	0.95	0.95	0.95	0.95	0.95	0.95	0.95	0.95	0.95	0.95
Percent Heavy Veh, %	2	2	2	2	2	2	2	2	2	2	2	2
Cap, veh/h	0	482	409	536	563	0	574	0	1022	0	2	0
Arrive On Green	0.00	0.26	0.26	0.30	0.30	0.00	0.32	0.00	0.32	0.00	0.00	0.00
Sat Flow, veh/h	0	1870	1585	1781	1870	0	1781	0	3170	0	1870	0
Grp Volume(v), veh/h	0	537	407	453	411	0	674	0	127	0	0	0
Grp Sat Flow(s),veh/h/ln	0	1870	1585	1781	1870	0	1781	0	1585	0	1870	0
Q Serve(g_s), s	0.0	20.0	19.9	18.5	15.3	0.0	25.0	0.0	2.2	0.0	0.0	0.0
Cycle Q Clear(g_c), s	0.0	20.0	19.9	18.5	15.3	0.0	25.0	0.0	2.2	0.0	0.0	0.0
Prop In Lane	0.00		1.00	1.00		0.00	1.00		1.00	0.00		0.00
Lane Grp Cap(c), veh/h	0	482	409	536	563	0	574	0	1022	0	2	0
V/C Ratio(X)	0.00	1.11	1.00	0.84	0.73	0.00	1.17	0.00	0.12	0.00	0.00	0.00
Avail Cap(c_a), veh/h	0	482	409	689	724	0	574	0	1022	0	193	0
HCM Platoon Ratio	1.00	1.00	1.00	1.00	1.00	1.00	1.00	1.00	1.00	1.00	1.00	1.00
Upstream Filter(I)	0.00	1.00	1.00	1.00	1.00	0.00	1.00	0.00	1.00	0.00	0.00	0.00
Uniform Delay (d), s/veh	0.0	28.8	28.7	25.4	24.3	0.0	26.3	0.0	18.5	0.0	0.0	0.0
Incr Delay (d2), s/veh	0.0	75.6	43.2	7.6	2.7	0.0	95.4	0.0	0.1	0.0	0.0	0.0
Initial Q Delay(d3),s/veh	0.0	0.0	0.0	0.0	0.0	0.0	0.0	0.0	0.0	0.0	0.0	0.0
%ile BackOfQ(50%),veh/ln	0.0	18.5	12.0	8.4	6.7	0.0	25.1	0.0	0.8	0.0	0.0	0.0
Unsig. Movement Delay, s/veh												
LnGrp Delay(d),s/veh	0.0	104.4	72.0	33.0	27.0	0.0	121.7	0.0	18.6	0.0	0.0	0.0
LnGrp LOS	A	F	E	C	C	A	F	A	B	A	A	A
Approach Vol, veh/h		944			864			801				0
Approach Delay, s/veh		90.4			30.2			105.3				0.0
Approach LOS		F			C			F				
Timer - Assigned Phs		2		4		6		8				
Phs Duration (G+Y+Rc), s		0.0		23.2		28.0		26.3				
Change Period (Y+Rc), s		3.0		3.2		3.0		3.0				
Max Green Setting (Gmax), s		8.0		20.0		25.0		30.0				
Max Q Clear Time (g_c+I1), s		0.0		22.0		27.0		20.5				
Green Ext Time (p_c), s		0.0		0.0		0.0		2.9				

### Intersection Summary

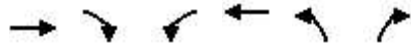
HCM 6th Ctrl Delay	75.0
HCM 6th LOS	E

### Notes

- User approved pedestrian interval to be less than phase max green.
- User approved volume balancing among the lanes for turning movement.

HCM 6th Signalized Intersection Summary  
 13: Todd Rd Overpass & Todd Rd

Cumulative Conditions PM



Movement	EBT	EBR	WBL	WBT	NBL	NBR
Lane Configurations	↑↑	↗	↖	↑↑	↖	↗↗
Traffic Volume (veh/h)	210	280	440	400	280	780
Future Volume (veh/h)	210	280	440	400	280	780
Initial Q (Qb), veh	0	0	0	0	0	0
Ped-Bike Adj(A_pbT)		1.00	1.00		1.00	1.00
Parking Bus, Adj	1.00	1.00	1.00	1.00	1.00	1.00
Work Zone On Approach	No			No	No	
Adj Sat Flow, veh/h/ln	1870	1870	1870	1870	1870	1870
Adj Flow Rate, veh/h	221	48	493	379	295	453
Peak Hour Factor	0.95	0.95	0.95	0.95	0.95	0.95
Percent Heavy Veh, %	2	2	2	2	2	2
Cap, veh/h	500	223	1084	569	454	1560
Arrive On Green	0.14	0.14	0.30	0.30	0.25	0.25
Sat Flow, veh/h	3647	1585	3563	1870	1781	2790
Grp Volume(v), veh/h	221	48	493	379	295	453
Grp Sat Flow(s),veh/h/ln	1777	1585	1781	1870	1781	1395
Q Serve(g_s), s	2.0	0.9	3.9	6.2	5.2	3.0
Cycle Q Clear(g_c), s	2.0	0.9	3.9	6.2	5.2	3.0
Prop In Lane		1.00	1.00		1.00	1.00
Lane Grp Cap(c), veh/h	500	223	1084	569	454	1560
V/C Ratio(X)	0.44	0.22	0.45	0.67	0.65	0.29
Avail Cap(c_a), veh/h	2032	906	1528	802	713	1965
HCM Platoon Ratio	1.00	1.00	1.00	1.00	1.00	1.00
Upstream Filter(I)	1.00	1.00	1.00	1.00	1.00	1.00
Uniform Delay (d), s/veh	13.8	13.3	9.8	10.6	11.6	4.1
Incr Delay (d2), s/veh	0.6	0.5	0.3	1.4	1.6	0.1
Initial Q Delay(d3),s/veh	0.0	0.0	0.0	0.0	0.0	0.0
%ile BackOfQ(50%),veh/ln	0.7	0.3	1.2	2.1	1.7	1.2
Unsig. Movement Delay, s/veh						
LnGrp Delay(d),s/veh	14.4	13.8	10.1	12.0	13.2	4.2
LnGrp LOS	B	B	B	B	B	A
Approach Vol, veh/h	269			872	748	
Approach Delay, s/veh	14.3			10.9	7.7	
Approach LOS	B			B	A	
Timer - Assigned Phs		2		6		8
Phs Duration (G+Y+Rc), s		8.4		14.1		12.4
Change Period (Y+Rc), s		3.5		3.5		3.5
Max Green Setting (Gmax), s		20.0		15.0		14.0
Max Q Clear Time (g_c+I1), s		4.0		8.2		7.2
Green Ext Time (p_c), s		1.3		2.5		1.8
<b>Intersection Summary</b>						
HCM 6th Ctrl Delay			10.1			
HCM 6th LOS			B			
<b>Notes</b>						
User approved volume balancing among the lanes for turning movement.						

# HCM 6th Signalized Intersection Summary

## 14: Santa Rosa Ave & Todd Rd

Cumulative Conditions PM



Movement	EBL	EBT	EBR	WBL	WBT	WBR	NBL	NBT	NBR	SBL	SBT	SBR
Lane Configurations	↖	↖	↖	↖	↖		↖	↑↑	↖	↖	↑↑	↖
Traffic Volume (veh/h)	520	70	400	60	120	70	390	680	50	40	580	330
Future Volume (veh/h)	520	70	400	60	120	70	390	680	50	40	580	330
Initial Q (Qb), veh	0	0	0	0	0	0	0	0	0	0	0	0
Ped-Bike Adj(A_pbT)	1.00		0.99	1.00		1.00	1.00		0.99	1.00		0.99
Parking Bus, Adj	1.00	1.00	1.00	1.00	1.00	1.00	1.00	1.00	1.00	1.00	1.00	1.00
Work Zone On Approach		No			No			No			No	
Adj Sat Flow, veh/h/ln	1870	1870	1870	1870	1870	1870	1870	1870	1870	1870	1870	1870
Adj Flow Rate, veh/h	600	0	77	63	126	47	411	716	18	42	611	67
Peak Hour Factor	0.95	0.95	0.95	0.95	0.95	0.95	0.95	0.95	0.95	0.95	0.95	0.95
Percent Heavy Veh, %	2	2	2	2	2	2	2	2	2	2	2	2
Cap, veh/h	699	0	309	214	156	58	391	1358	602	55	701	310
Arrive On Green	0.20	0.00	0.20	0.12	0.12	0.12	0.22	0.38	0.38	0.03	0.20	0.20
Sat Flow, veh/h	3563	0	1573	1781	1299	484	1781	3554	1575	1781	3554	1573
Grp Volume(v), veh/h	600	0	77	63	0	173	411	716	18	42	611	67
Grp Sat Flow(s),veh/h/ln	1781	0	1573	1781	0	1783	1781	1777	1575	1781	1777	1573
Q Serve(g_s), s	12.6	0.0	3.2	2.5	0.0	7.3	17.0	12.1	0.6	1.8	12.9	2.8
Cycle Q Clear(g_c), s	12.6	0.0	3.2	2.5	0.0	7.3	17.0	12.1	0.6	1.8	12.9	2.8
Prop In Lane	1.00		1.00	1.00		0.27	1.00		1.00	1.00		1.00
Lane Grp Cap(c), veh/h	699	0	309	214	0	214	391	1358	602	55	701	310
V/C Ratio(X)	0.86	0.00	0.25	0.29	0.00	0.81	1.05	0.53	0.03	0.77	0.87	0.22
Avail Cap(c_a), veh/h	827	0	365	230	0	230	391	1358	602	230	733	325
HCM Platoon Ratio	1.00	1.00	1.00	1.00	1.00	1.00	1.00	1.00	1.00	1.00	1.00	1.00
Upstream Filter(I)	1.00	0.00	1.00	1.00	0.00	1.00	1.00	1.00	1.00	1.00	1.00	1.00
Uniform Delay (d), s/veh	30.1	0.0	26.3	31.1	0.0	33.2	30.3	18.5	15.0	37.3	30.2	26.1
Incr Delay (d2), s/veh	7.0	0.0	0.2	0.3	0.0	16.2	59.9	0.2	0.0	8.1	10.2	0.1
Initial Q Delay(d3),s/veh	0.0	0.0	0.0	0.0	0.0	0.0	0.0	0.0	0.0	0.0	0.0	0.0
%ile BackOfQ(50%),veh/ln	5.9	0.0	1.2	1.1	0.0	4.1	13.4	4.6	0.2	0.9	6.1	1.0
Unsig. Movement Delay, s/veh												
LnGrp Delay(d),s/veh	37.1	0.0	26.5	31.4	0.0	49.4	90.2	18.7	15.0	45.4	40.4	26.2
LnGrp LOS	D	A	C	C	A	D	F	B	B	D	D	C
Approach Vol, veh/h		677			236			1145			720	
Approach Delay, s/veh		35.9			44.6			44.3			39.3	
Approach LOS		D			D			D			D	
Timer - Assigned Phs		2	3	4		6	7	8				
Phs Duration (G+Y+Rc), s		20.3	22.1	20.7		14.4	7.8	35.0				
Change Period (Y+Rc), s		5.1	5.1	5.4		5.1	5.4	* 5.4				
Max Green Setting (Gmax), s		18.0	17.0	16.0		10.0	10.0	* 24				
Max Q Clear Time (g_c+I1), s		14.6	19.0	14.9		9.3	3.8	14.1				
Green Ext Time (p_c), s		0.4	0.0	0.3		0.0	0.0	1.9				

### Intersection Summary

HCM 6th Ctrl Delay	41.0
HCM 6th LOS	D

### Notes

- User approved pedestrian interval to be less than phase max green.
- User approved volume balancing among the lanes for turning movement.
- \* HCM 6th computational engine requires equal clearance times for the phases crossing the barrier.

HCM 6th AWSC  
 15: Arnold Dr & Warm Springs Rd/Private Dwy

Cumulative Conditions PM

Intersection												
Intersection Delay, s/veh	13.5											
Intersection LOS	B											

Movement	EBL	EBT	EBR	WBL	WBT	WBR	NBL	NBT	NBR	SBL	SBT	SBR
Lane Configurations		↕			↕			↕			↕	
Traffic Vol, veh/h	60	20	220	20	20	20	160	180	20	20	140	70
Future Vol, veh/h	60	20	220	20	20	20	160	180	20	20	140	70
Peak Hour Factor	0.95	0.95	0.95	0.95	0.95	0.95	0.95	0.95	0.95	0.95	0.95	0.95
Heavy Vehicles, %	2	2	2	2	2	2	2	2	2	2	2	2
Mvmt Flow	63	21	232	21	21	21	168	189	21	21	147	74
Number of Lanes	0	1	0	0	1	0	0	1	0	0	1	0

Approach	EB	WB	NB	SB
Opposing Approach	WB	EB	SB	NB
Opposing Lanes	1	1	1	1
Conflicting Approach Left	SB	NB	EB	WB
Conflicting Lanes Left	1	1	1	1
Conflicting Approach Right	NB	SB	WB	EB
Conflicting Lanes Right	1	1	1	1
HCM Control Delay	13	9.9	15.6	11.6
HCM LOS	B	A	C	B

Lane	NBLn1	EBLn1	WBLn1	SBLn1
Vol Left, %	44%	20%	33%	9%
Vol Thru, %	50%	7%	33%	61%
Vol Right, %	6%	73%	33%	30%
Sign Control	Stop	Stop	Stop	Stop
Traffic Vol by Lane	360	300	60	230
LT Vol	160	60	20	20
Through Vol	180	20	20	140
RT Vol	20	220	20	70
Lane Flow Rate	379	316	63	242
Geometry Grp	1	1	1	1
Degree of Util (X)	0.573	0.467	0.107	0.366
Departure Headway (Hd)	5.445	5.322	6.089	5.447
Convergence, Y/N	Yes	Yes	Yes	Yes
Cap	659	673	585	659
Service Time	3.495	3.378	4.168	3.505
HCM Lane V/C Ratio	0.575	0.47	0.108	0.367
HCM Control Delay	15.6	13	9.9	11.6
HCM Lane LOS	C	B	A	B
HCM 95th-tile Q	3.6	2.5	0.4	1.7

HCM 6th TWSC  
16: Riverside Dr & Verano Ave

Cumulative Conditions PM

Intersection												
Int Delay, s/veh	91.5											
Movement	EBL	EBT	EBR	WBL	WBT	WBR	NBL	NBT	NBR	SBL	SBT	SBR
Lane Configurations												
Traffic Vol, veh/h	60	330	130	80	390	150	30	90	30	80	60	40
Future Vol, veh/h	60	330	130	80	390	150	30	90	30	80	60	40
Conflicting Peds, #/hr	0	0	0	0	0	0	0	0	0	0	0	0
Sign Control	Free	Free	Free	Free	Free	Free	Stop	Stop	Stop	Stop	Stop	Stop
RT Channelized	-	-	None	-	-	None	-	-	None	-	-	None
Storage Length	100	-	-	-	-	-	-	-	-	-	-	-
Veh in Median Storage, #	-	0	-	-	0	-	-	0	-	-	0	-
Grade, %	-	0	-	-	0	-	-	0	-	-	0	-
Peak Hour Factor	95	95	95	95	95	95	95	95	95	95	95	95
Heavy Vehicles, %	2	2	2	2	2	2	2	2	2	2	2	2
Mvmt Flow	63	347	137	84	411	158	32	95	32	84	63	42

Major/Minor	Major1			Major2			Minor1			Minor2		
Conflicting Flow All	569	0	0	484	0	0	1253	1279	416	1263	1268	490
Stage 1	-	-	-	-	-	-	542	542	-	658	658	-
Stage 2	-	-	-	-	-	-	711	737	-	605	610	-
Critical Hdwy	4.12	-	-	4.12	-	-	7.12	6.52	6.22	7.12	6.52	6.22
Critical Hdwy Stg 1	-	-	-	-	-	-	6.12	5.52	-	6.12	5.52	-
Critical Hdwy Stg 2	-	-	-	-	-	-	6.12	5.52	-	6.12	5.52	-
Follow-up Hdwy	2.218	-	-	2.218	-	-	3.518	4.018	3.318	3.518	4.018	3.318
Pot Cap-1 Maneuver	1003	-	-	1079	-	-	149	166	637	147	168	578
Stage 1	-	-	-	-	-	-	525	520	-	453	461	-
Stage 2	-	-	-	-	-	-	424	425	-	485	485	-
Platoon blocked, %		-	-		-	-						
Mov Cap-1 Maneuver	1003	-	-	1079	-	-	78	137	637	~ 55	139	578
Mov Cap-2 Maneuver	-	-	-	-	-	-	78	137	-	~ 55	139	-
Stage 1	-	-	-	-	-	-	492	487	-	424	407	-
Stage 2	-	-	-	-	-	-	293	375	-	348	454	-

Approach	EB			WB			NB			SB		
HCM Control Delay, s	1			1.1			183.9			\$ 587.6		
HCM LOS							F			F		

Minor Lane/Major Mvmt	NBLn1	EBL	EBT	EBR	WBL	WBT	WBR	SBLn1	
Capacity (veh/h)	138	1003	-	-	1079	-	-	92	
HCM Lane V/C Ratio	1.144	0.063	-	-	0.078	-	-	2.059	
HCM Control Delay (s)	183.9	8.8	-	-	8.6	0	-	\$ 587.6	
HCM Lane LOS		F	A	-	-	A	A	-	F
HCM 95th %tile Q(veh)		9	0.2	-	-	0.3	-	-	16.5

Notes  
 -: Volume exceeds capacity    \$: Delay exceeds 300s    +: Computation Not Defined    \*: All major volume in platoon

HCM 6th Signalized Intersection Summary  
 17: Main St/Petaluma Hill Rd & Old Adobe Rd/Adobe Rd

Cumulative Conditions PM



Movement	EBL	EBT	EBR	WBL	WBT	WBR	NBL	NBT	NBR	SBL	SBT	SBR
Lane Configurations		↕			↕			↕		↕	↕	↕
Traffic Volume (veh/h)	50	190	80	30	260	560	60	910	30	380	410	50
Future Volume (veh/h)	50	190	80	30	260	560	60	910	30	380	410	50
Initial Q (Qb), veh	0	0	0	0	0	0	0	0	0	0	0	0
Ped-Bike Adj(A_pbT)	1.00		0.99	1.00		0.99	1.00		1.00	1.00		0.99
Parking Bus, Adj	1.00	1.00	1.00	1.00	1.00	1.00	1.00	1.00	1.00	1.00	1.00	1.00
Work Zone On Approach		No			No			No			No	
Adj Sat Flow, veh/h/ln	1870	1870	1870	1870	1870	1870	1870	1870	1870	1870	1870	1870
Adj Flow Rate, veh/h	53	200	67	32	274	492	63	958	30	400	432	47
Peak Hour Factor	0.95	0.95	0.95	0.95	0.95	0.95	0.95	0.95	0.95	0.95	0.95	0.95
Percent Heavy Veh, %	2	2	2	2	2	2	2	2	2	2	2	2
Cap, veh/h	102	351	106	63	223	381	28	418	13	318	295	32
Arrive On Green	0.37	0.37	0.37	0.37	0.37	0.37	0.25	0.25	0.25	0.18	0.18	0.18
Sat Flow, veh/h	127	940	283	37	597	1019	111	1691	53	1781	1655	180
Grp Volume(v), veh/h	320	0	0	798	0	0	1051	0	0	400	0	479
Grp Sat Flow(s),veh/h/ln	1350	0	0	1653	0	0	1855	0	0	1781	0	1835
Q Serve(g_s), s	0.0	0.0	0.0	16.1	0.0	0.0	19.0	0.0	0.0	13.7	0.0	13.7
Cycle Q Clear(g_c), s	11.3	0.0	0.0	28.7	0.0	0.0	19.0	0.0	0.0	13.7	0.0	13.7
Prop In Lane	0.17		0.21	0.04		0.62	0.06		0.03	1.00		0.10
Lane Grp Cap(c), veh/h	559	0	0	667	0	0	459	0	0	318	0	327
V/C Ratio(X)	0.57	0.00	0.00	1.20	0.00	0.00	2.29	0.00	0.00	1.26	0.00	1.46
Avail Cap(c_a), veh/h	559	0	0	667	0	0	459	0	0	318	0	327
HCM Platoon Ratio	1.00	1.00	1.00	1.00	1.00	1.00	1.00	1.00	1.00	1.00	1.00	1.00
Upstream Filter(I)	1.00	0.00	0.00	1.00	0.00	0.00	1.00	0.00	0.00	1.00	0.00	1.00
Uniform Delay (d), s/veh	18.3	0.0	0.0	25.0	0.0	0.0	28.9	0.0	0.0	31.6	0.0	31.6
Incr Delay (d2), s/veh	0.9	0.0	0.0	102.8	0.0	0.0	587.3	0.0	0.0	139.5	0.0	224.6
Initial Q Delay(d3),s/veh	0.0	0.0	0.0	0.0	0.0	0.0	0.0	0.0	0.0	0.0	0.0	0.0
%ile BackOfQ(50%),veh/ln	4.1	0.0	0.0	30.2	0.0	0.0	83.1	0.0	0.0	17.9	0.0	26.2
Unsig. Movement Delay, s/veh												
LnGrp Delay(d),s/veh	19.3	0.0	0.0	127.8	0.0	0.0	616.2	0.0	0.0	171.0	0.0	256.2
LnGrp LOS	B	A	A	F	A	A	F	A	A	F	A	F
Approach Vol, veh/h		320			798			1051				879
Approach Delay, s/veh		19.3			127.8			616.2				217.4
Approach LOS		B			F			F				F
Timer - Assigned Phs		2		4		6		8				
Phs Duration (G+Y+Rc), s		23.6		34.1		19.1		34.1				
Change Period (Y+Rc), s		4.6		* 5.4		5.4		5.4				
Max Green Setting (Gmax), s		19.0		* 24		13.7		28.7				
Max Q Clear Time (g_c+I1), s		21.0		13.3		15.7		30.7				
Green Ext Time (p_c), s		0.0		0.7		0.0		0.0				

Intersection Summary

HCM 6th Ctrl Delay	310.7
HCM 6th LOS	F

Notes

User approved pedestrian interval to be less than phase max green.  
 \* HCM 6th computational engine requires equal clearance times for the phases crossing the barrier.

HCM 6th Signalized Intersection Summary  
 18: Old Redwood Hwy & Main St

Cumulative Conditions PM



Movement	WBL	WBR	NBT	NBR	SBL	SBT
Lane Configurations						
Traffic Volume (veh/h)	440	30	710	910	30	330
Future Volume (veh/h)	440	30	710	910	30	330
Initial Q (Qb), veh	0	0	0	0	0	0
Ped-Bike Adj(A_pbT)	1.00	1.00		1.00	1.00	
Parking Bus, Adj	1.00	1.00	1.00	1.00	1.00	1.00
Work Zone On Approach	No		No		No	
Adj Sat Flow, veh/h/ln	1870	1870	1870	1870	1870	1870
Adj Flow Rate, veh/h	463	8	747	958	32	347
Peak Hour Factor	0.95	0.95	0.95	0.95	0.95	0.95
Percent Heavy Veh, %	2	2	2	2	2	2
Cap, veh/h	506	450	823	698	48	1043
Arrive On Green	0.28	0.28	0.44	0.44	0.03	0.56
Sat Flow, veh/h	1781	1585	1870	1585	1781	1870
Grp Volume(v), veh/h	463	8	747	958	32	347
Grp Sat Flow(s),veh/h/ln	1781	1585	1870	1585	1781	1870
Q Serve(g_s), s	17.1	0.2	25.4	30.0	1.2	6.9
Cycle Q Clear(g_c), s	17.1	0.2	25.4	30.0	1.2	6.9
Prop In Lane	1.00	1.00		1.00	1.00	
Lane Grp Cap(c), veh/h	506	450	823	698	48	1043
V/C Ratio(X)	0.92	0.02	0.91	1.37	0.67	0.33
Avail Cap(c_a), veh/h	784	698	823	698	314	1043
HCM Platoon Ratio	1.00	1.00	1.00	1.00	1.00	1.00
Upstream Filter(I)	1.00	1.00	1.00	1.00	1.00	1.00
Uniform Delay (d), s/veh	23.6	17.6	17.8	19.1	32.9	8.2
Incr Delay (d2), s/veh	7.9	0.0	13.4	177.0	6.0	0.1
Initial Q Delay(d3),s/veh	0.0	0.0	0.0	0.0	0.0	0.0
%ile BackOfQ(50%),veh/ln	7.9	0.1	12.1	43.3	0.6	2.2
Unsig. Movement Delay, s/veh						
LnGrp Delay(d),s/veh	31.5	17.6	31.2	196.1	38.9	8.3
LnGrp LOS	C	B	C	F	D	A
Approach Vol, veh/h	471		1705			379
Approach Delay, s/veh	31.3		123.9			10.8
Approach LOS	C		F			B
Timer - Assigned Phs	1	2		4		6
Phs Duration (G+Y+Rc), s	8.0	36.2		23.9		44.2
Change Period (Y+Rc), s	6.2	6.2		4.6		6.2
Max Green Setting (Gmax)	30.0	30.0		30.0		30.0
Max Q Clear Time (g_c+1)	32.0	32.0		19.1		8.9
Green Ext Time (p_c), s	0.0	0.0		0.2		0.6

Intersection Summary

HCM 6th Ctrl Delay	90.0
HCM 6th LOS	F

Notes

User approved pedestrian interval to be less than phase max green.



HCM 6th TWSC  
 19: Private Dwy/Paula Ln & Bodega Ave

Cumulative Conditions PM

Intersection												
Int Delay, s/veh	1.5											
Movement	EBL	EBT	EBR	WBL	WBT	WBR	NBL	NBT	NBR	SBL	SBT	SBR
Lane Configurations	↖	↗		↖	↗			↕			↕	
Traffic Vol, veh/h	30	420	0	0	510	30	0	0	0	30	0	30
Future Vol, veh/h	30	420	0	0	510	30	0	0	0	30	0	30
Conflicting Peds, #/hr	0	0	0	0	0	0	0	0	0	0	0	0
Sign Control	Free	Free	Free	Free	Free	Free	Stop	Stop	Stop	Stop	Stop	Stop
RT Channelized	-	-	None	-	-	None	-	-	None	-	-	None
Storage Length	90	-	-	90	-	-	-	-	-	-	-	-
Veh in Median Storage, #	-	0	-	-	0	-	-	0	-	-	0	-
Grade, %	-	0	-	-	0	-	-	0	-	-	0	-
Peak Hour Factor	95	95	95	95	95	95	95	95	95	95	95	95
Heavy Vehicles, %	2	2	2	2	2	2	2	2	2	2	2	2
Mvmt Flow	32	442	0	0	537	32	0	0	0	32	0	32

Major/Minor	Major1			Major2			Minor1			Minor2		
Conflicting Flow All	569	0	0	442	0	0	1075	1075	442	1059	1059	553
Stage 1	-	-	-	-	-	-	506	506	-	553	553	-
Stage 2	-	-	-	-	-	-	569	569	-	506	506	-
Critical Hdwy	4.12	-	-	4.12	-	-	7.12	6.52	6.22	7.12	6.52	6.22
Critical Hdwy Stg 1	-	-	-	-	-	-	6.12	5.52	-	6.12	5.52	-
Critical Hdwy Stg 2	-	-	-	-	-	-	6.12	5.52	-	6.12	5.52	-
Follow-up Hdwy	2.218	-	-	2.218	-	-	3.518	4.018	3.318	3.518	4.018	3.318
Pot Cap-1 Maneuver	1003	-	-	1118	-	-	197	220	615	202	224	533
Stage 1	-	-	-	-	-	-	549	540	-	517	514	-
Stage 2	-	-	-	-	-	-	507	506	-	549	540	-
Platoon blocked, %	-	-	-	-	-	-	-	-	-	-	-	-
Mov Cap-1 Maneuver	1003	-	-	1118	-	-	181	213	615	197	217	533
Mov Cap-2 Maneuver	-	-	-	-	-	-	181	213	-	197	217	-
Stage 1	-	-	-	-	-	-	531	523	-	500	514	-
Stage 2	-	-	-	-	-	-	477	506	-	531	523	-






















Approach	EB	WB	NB	SB
HCM Control Delay, s	0.6	0	0	21
HCM LOS			A	C

Minor Lane/Major Mvmt	NBLn1	EBL	EBT	EBR	WBL	WBT	WBR	SBLn1
Capacity (veh/h)	-	1003	-	-	1118	-	-	288
HCM Lane V/C Ratio	-	0.031	-	-	-	-	-	0.219
HCM Control Delay (s)		0	8.7	-	-	0	-	21
HCM Lane LOS		A	A	-	-	A	-	C
HCM 95th %tile Q(veh)	-	0.1	-	-	0	-	-	0.8

# HCM 6th Signalized Intersection Summary

## 20: Broadway & Leveroni Rd/Napa Rd

Cumulative Conditions PM

												
Movement	EBL	EBT	EBR	WBL	WBT	WBR	NBL	NBT	NBR	SBL	SBT	SBR
Lane Configurations												
Traffic Volume (veh/h)	130	390	70	80	420	270	80	280	120	270	290	130
Future Volume (veh/h)	130	390	70	80	420	270	80	280	120	270	290	130
Initial Q (Qb), veh	0	0	0	0	0	0	0	0	0	0	0	0
Ped-Bike Adj(A_pbT)	1.00		1.00	1.00		1.00	1.00		0.98	1.00		0.99
Parking Bus, Adj	1.00	1.00	1.00	1.00	1.00	1.00	1.00	1.00	1.00	1.00	1.00	1.00
Work Zone On Approach		No			No			No			No	
Adj Sat Flow, veh/h/ln	1870	1870	1870	1870	1870	1870	1870	1870	1870	1870	1870	1870
Adj Flow Rate, veh/h	137	411	69	84	442	265	84	295	81	284	305	90
Peak Hour Factor	0.95	0.95	0.95	0.95	0.95	0.95	0.95	0.95	0.95	0.95	0.95	0.95
Percent Heavy Veh, %	2	2	2	2	2	2	2	2	2	2	2	2
Cap, veh/h	214	565	95	193	383	230	193	431	116	318	613	178
Arrive On Green	0.12	0.36	0.36	0.11	0.35	0.35	0.11	0.16	0.16	0.18	0.23	0.23
Sat Flow, veh/h	1781	1560	262	1781	1093	656	1781	2757	742	1781	2711	785
Grp Volume(v), veh/h	137	0	480	84	0	707	84	188	188	284	198	197
Grp Sat Flow(s),veh/h/ln	1781	0	1822	1781	0	1749	1781	1777	1722	1781	1777	1719
Q Serve(g_s), s	6.5	0.0	20.2	3.9	0.0	31.0	3.9	8.8	9.1	13.8	8.6	8.9
Cycle Q Clear(g_c), s	6.5	0.0	20.2	3.9	0.0	31.0	3.9	8.8	9.1	13.8	8.6	8.9
Prop In Lane	1.00		0.14	1.00		0.37	1.00		0.43	1.00		0.46
Lane Grp Cap(c), veh/h	214	0	660	193	0	613	193	278	269	318	402	389
V/C Ratio(X)	0.64	0.00	0.73	0.43	0.00	1.15	0.43	0.68	0.70	0.89	0.49	0.51
Avail Cap(c_a), veh/h	524	0	660	524	0	613	222	542	526	322	542	525
HCM Platoon Ratio	1.00	1.00	1.00	1.00	1.00	1.00	1.00	1.00	1.00	1.00	1.00	1.00
Upstream Filter(I)	1.00	0.00	1.00	1.00	0.00	1.00	1.00	1.00	1.00	1.00	1.00	1.00
Uniform Delay (d), s/veh	37.1	0.0	24.4	36.9	0.0	28.7	36.9	35.2	35.3	35.5	29.8	29.9
Incr Delay (d2), s/veh	3.2	0.0	4.0	1.5	0.0	86.5	1.5	2.9	3.3	25.2	0.9	1.0
Initial Q Delay(d3),s/veh	0.0	0.0	0.0	0.0	0.0	0.0	0.0	0.0	0.0	0.0	0.0	0.0
%ile BackOfQ(50%),veh/ln	2.9	0.0	8.6	1.7	0.0	26.6	1.7	3.8	3.9	8.0	3.6	3.7
Unsig. Movement Delay, s/veh												
LnGrp Delay(d),s/veh	40.3	0.0	28.5	38.4	0.0	115.2	38.4	38.1	38.6	60.7	30.7	30.9
LnGrp LOS	D	A	C	D	A	F	D	D	D	E	C	C
Approach Vol, veh/h		617			791			460			679	
Approach Delay, s/veh		31.1			107.1			38.3			43.3	
Approach LOS		C			F			D			D	
Timer - Assigned Phs	1	2	3	4	5	6	7	8				
Phs Duration (G+Y+Rc), s	13.6	25.0	14.6	35.2	19.8	18.8	13.6	36.2				
Change Period (Y+Rc), s	4.0	5.0	4.0	* 4.2	4.0	5.0	4.0	* 4.2				
Max Green Setting (Gmax), s	11.0	27.0	26.0	* 31	16.0	27.0	26.0	* 31				
Max Q Clear Time (g_c+I1), s	5.9	10.9	8.5	33.0	15.8	11.1	5.9	22.2				
Green Ext Time (p_c), s	0.1	2.0	0.3	0.0	0.0	1.7	0.2	1.8				
<b>Intersection Summary</b>												
HCM 6th Ctrl Delay			59.3									
HCM 6th LOS			E									
<b>Notes</b>												
* HCM 6th computational engine requires equal clearance times for the phases crossing the barrier.												

**ATTACHMENT C-4**

**CUMULATIVE WITH PROGRAM CONDITIONS OUPUTS**



HCM 6th AWSC  
 1: Geyserville Ave & Canyon Road

Cumulative plus Project Conditions AM

Intersection	
Intersection Delay, s/veh	9.5
Intersection LOS	A

Movement	EBL	EBT	EBR	WBL	WBT	WBR	NBL	NBT	NBR	SBL	SBT	SBR
Lane Configurations		↔			↔			↔			↔	
Traffic Vol, veh/h	50	20	218	20	20	20	138	30	20	20	30	30
Future Vol, veh/h	50	20	218	20	20	20	138	30	20	20	30	30
Peak Hour Factor	0.95	0.95	0.95	0.95	0.95	0.95	0.95	0.95	0.95	0.95	0.95	0.95
Heavy Vehicles, %	2	2	2	2	2	2	2	2	2	2	2	2
Mvmt Flow	53	21	229	21	21	21	145	32	21	21	32	32
Number of Lanes	0	1	0	0	1	0	0	1	0	0	1	0

Approach	EB	WB	NB	SB
Opposing Approach	WB	EB	SB	NB
Opposing Lanes	1	1	1	1
Conflicting Approach Left	SB	NB	EB	WB
Conflicting Lanes Left	1	1	1	1
Conflicting Approach Right	NB	SB	WB	EB
Conflicting Lanes Right	1	1	1	1
HCM Control Delay	9.8	8.4	9.8	8.5
HCM LOS	A	A	A	A

Lane	NBLn1	EBLn1	WBLn1	SBLn1
Vol Left, %	73%	17%	33%	25%
Vol Thru, %	16%	7%	33%	38%
Vol Right, %	11%	76%	33%	38%
Sign Control	Stop	Stop	Stop	Stop
Traffic Vol by Lane	188	288	60	80
LT Vol	138	50	20	20
Through Vol	30	20	20	30
RT Vol	20	218	20	30
Lane Flow Rate	198	303	63	84
Geometry Grp	1	1	1	1
Degree of Util (X)	0.271	0.361	0.085	0.113
Departure Headway (Hd)	4.936	4.292	4.845	4.834
Convergence, Y/N	Yes	Yes	Yes	Yes
Cap	724	837	735	736
Service Time	2.99	2.331	2.903	2.897
HCM Lane V/C Ratio	0.273	0.362	0.086	0.114
HCM Control Delay	9.8	9.8	8.4	8.5
HCM Lane LOS	A	A	A	A
HCM 95th-tile Q	1.1	1.7	0.3	0.4

# HCM 6th Signalized Intersection Summary

## 2: Armstrong Woods Rd & River Rd

Cumulative plus Project Conditions AM



Movement	EBL	EBT	EBR	WBL	WBT	WBR	NBL	NBT	NBR	SBL	SBT	SBR
Lane Configurations												
Traffic Volume (veh/h)	95	520	0	0	540	158	20	42	40	224	0	60
Future Volume (veh/h)	95	520	0	0	540	158	20	42	40	224	0	60
Initial Q (Qb), veh	0	0	0	0	0	0	0	0	0	0	0	0
Ped-Bike Adj(A_pbT)	1.00		1.00	1.00		0.99	0.99		0.99	0.99		0.99
Parking Bus, Adj	1.00	1.00	1.00	1.00	1.00	1.00	1.00	1.00	1.00	1.00	1.00	1.00
Work Zone On Approach		No			No			No			No	
Adj Sat Flow, veh/h/ln	1870	1870	0	0	1870	1870	1870	1870	1870	1870	1870	1870
Adj Flow Rate, veh/h	100	547	0	0	568	87	21	44	9	236	0	15
Peak Hour Factor	0.95	0.95	0.95	0.95	0.95	0.95	0.95	0.95	0.95	0.95	0.95	0.95
Percent Heavy Veh, %	2	2	0	0	2	2	2	2	2	2	2	2
Cap, veh/h	415	1088	0	0	733	617	459	363	74	428	0	378
Arrive On Green	0.10	0.58	0.00	0.00	0.39	0.39	0.24	0.24	0.24	0.24	0.00	0.24
Sat Flow, veh/h	1781	1870	0	0	1870	1575	1384	1504	308	1339	0	1569
Grp Volume(v), veh/h	100	547	0	0	568	87	21	0	53	236	0	15
Grp Sat Flow(s),veh/h/ln	1781	1870	0	0	1870	1575	1384	0	1811	1339	0	1569
Q Serve(g_s), s	1.5	9.2	0.0	0.0	14.1	1.9	0.6	0.0	1.2	8.9	0.0	0.4
Cycle Q Clear(g_c), s	1.5	9.2	0.0	0.0	14.1	1.9	1.0	0.0	1.2	10.1	0.0	0.4
Prop In Lane	1.00		0.00	0.00		1.00	1.00		0.17	1.00		1.00
Lane Grp Cap(c), veh/h	415	1088	0	0	733	617	459	0	437	428	0	378
V/C Ratio(X)	0.24	0.50	0.00	0.00	0.77	0.14	0.05	0.00	0.12	0.55	0.00	0.04
Avail Cap(c_a), veh/h	468	1126	0	0	1478	1245	594	0	613	558	0	531
HCM Platoon Ratio	1.00	1.00	1.00	1.00	1.00	1.00	1.00	1.00	1.00	1.00	1.00	1.00
Upstream Filter(I)	1.00	1.00	0.00	0.00	1.00	1.00	1.00	0.00	1.00	1.00	0.00	1.00
Uniform Delay (d), s/veh	9.0	6.6	0.0	0.0	14.1	10.4	15.8	0.0	15.8	19.7	0.0	15.4
Incr Delay (d2), s/veh	0.3	0.4	0.0	0.0	1.8	0.1	0.0	0.0	0.1	1.1	0.0	0.0
Initial Q Delay(d3),s/veh	0.0	0.0	0.0	0.0	0.0	0.0	0.0	0.0	0.0	0.0	0.0	0.0
%ile BackOfQ(50%),veh/ln	0.5	2.8	0.0	0.0	5.5	0.6	0.2	0.0	0.5	2.7	0.0	0.1
Unsig. Movement Delay, s/veh												
LnGrp Delay(d),s/veh	9.3	6.9	0.0	0.0	15.9	10.5	15.9	0.0	15.9	20.8	0.0	15.5
LnGrp LOS	A	A	A	A	B	B	B	A	B	C	A	B
Approach Vol, veh/h		647			655			74		251		
Approach Delay, s/veh		7.3			15.2			15.9		20.5		
Approach LOS		A			B			B		C		
Timer - Assigned Phs		2		4	5	6		8				
Phs Duration (G+Y+Rc), s		35.6		17.5	10.1	25.5		17.5				
Change Period (Y+Rc), s		* 4.7		* 4.7	* 4.7	* 4.7		* 4.7				
Max Green Setting (Gmax), s		* 32		* 18	* 7	* 42		* 18				
Max Q Clear Time (g_c+I1), s		11.2		12.1	3.5	16.1		3.2				
Green Ext Time (p_c), s		3.8		0.4	0.1	4.6		0.2				

### Intersection Summary

HCM 6th Ctrl Delay	12.9
HCM 6th LOS	B

### Notes

- User approved pedestrian interval to be less than phase max green.
- \* HCM 6th computational engine requires equal clearance times for the phases crossing the barrier.

# HCM 6th Signalized Intersection Summary

## 3: Gravenstein Hwy/Old River Rd & River Rd

Cumulative plus Project Conditions AM



Movement	EBL	EBT	EBR	WBL	WBT	WBR	NBL	NBT	NBR	SBL	SBT	SBR
Lane Configurations		↑	↗	↖	↗	↖	↗	↖			↕	
Traffic Volume (veh/h)	0	545	239	40	500	20	178	50	120	20	40	20
Future Volume (veh/h)	0	545	239	40	500	20	178	50	120	20	40	20
Initial Q (Qb), veh	0	0	0	0	0	0	0	0	0	0	0	0
Ped-Bike Adj(A_pbT)	1.00		0.99	1.00		1.00	0.99		1.00	1.00		0.99
Parking Bus, Adj	1.00	1.00	1.00	1.00	1.00	1.00	1.00	1.00	1.00	1.00	1.00	1.00
Work Zone On Approach		No			No			No			No	
Adj Sat Flow, veh/h/ln	0	1870	1870	1870	1870	1870	1870	1870	1870	1870	1870	1870
Adj Flow Rate, veh/h	0	574	194	42	526	19	187	53	26	21	42	4
Peak Hour Factor	0.95	0.95	0.95	0.95	0.95	0.95	0.95	0.95	0.95	0.95	0.95	0.95
Percent Heavy Veh, %	0	2	2	2	2	2	2	2	2	2	2	2
Cap, veh/h	0	737	621	399	1046	38	449	240	118	170	265	21
Arrive On Green	0.00	0.39	0.39	0.08	0.58	0.58	0.20	0.20	0.20	0.20	0.20	0.20
Sat Flow, veh/h	0	1870	1575	1781	1794	65	1345	1185	581	308	1312	103
Grp Volume(v), veh/h	0	574	194	42	0	545	187	0	79	67	0	0
Grp Sat Flow(s),veh/h/ln	0	1870	1575	1781	0	1858	1345	0	1766	1722	0	0
Q Serve(g_s), s	0.0	11.8	3.7	0.5	0.0	7.6	3.9	0.0	1.6	0.0	0.0	0.0
Cycle Q Clear(g_c), s	0.0	11.8	3.7	0.5	0.0	7.6	5.2	0.0	1.6	1.3	0.0	0.0
Prop In Lane	0.00		1.00	1.00		0.03	1.00		0.33	0.31		0.06
Lane Grp Cap(c), veh/h	0	737	621	399	0	1084	449	0	357	456	0	0
V/C Ratio(X)	0.00	0.78	0.31	0.11	0.00	0.50	0.42	0.00	0.22	0.15	0.00	0.00
Avail Cap(c_a), veh/h	0	1023	861	617	0	1084	1096	0	1207	498	0	0
HCM Platoon Ratio	1.00	1.00	1.00	1.00	1.00	1.00	1.00	1.00	1.00	1.00	1.00	1.00
Upstream Filter(I)	0.00	1.00	1.00	1.00	0.00	1.00	1.00	0.00	1.00	1.00	0.00	0.00
Uniform Delay (d), s/veh	0.0	11.6	9.2	7.4	0.0	5.4	15.9	0.0	14.6	14.5	0.0	0.0
Incr Delay (d2), s/veh	0.0	2.6	0.3	0.1	0.0	0.4	0.6	0.0	0.3	0.1	0.0	0.0
Initial Q Delay(d3),s/veh	0.0	0.0	0.0	0.0	0.0	0.0	0.0	0.0	0.0	0.0	0.0	0.0
%ile BackOfQ(50%),veh/ln	0.0	4.4	1.1	0.1	0.0	2.0	1.6	0.0	0.6	0.5	0.0	0.0
Unsig. Movement Delay, s/veh												
LnGrp Delay(d),s/veh	0.0	14.2	9.5	7.6	0.0	5.8	16.5	0.0	14.9	14.6	0.0	0.0
LnGrp LOS		A	B	A	A	A	B	A	B	B	A	A
Approach Vol, veh/h		768			587			266			67	
Approach Delay, s/veh		13.0			5.9			16.0			14.6	
Approach LOS		B			A			B			B	
Timer - Assigned Phs	1	2	4	6	8							
Phs Duration (G+Y+Rc), s	22.0		13.6	30.3	13.6							
Change Period (Y+Rc), s	* 4.7		* 4.7	* 4.7	* 4.7							
Max Green Setting (Gmax), s	* 24		* 10	* 24	* 30							
Max Q Clear Time (g_c+1), s	13.8		3.3	9.6	7.2							
Green Ext Time (p_c), s	0.0	3.4	0.1	3.3	1.0							

### Intersection Summary

HCM 6th Ctrl Delay	11.1
HCM 6th LOS	B

### Notes

- User approved pedestrian interval to be less than phase max green.
- \* HCM 6th computational engine requires equal clearance times for the phases crossing the barrier.

HCM 6th TWSC  
4: Old Redwood Hwy & Fulton Rd

Cumulative plus Project Conditions AM

Intersection						
Int Delay, s/veh	13.8					
Movement	EBL	EBR	NBL	NBT	SBT	SBR
Lane Configurations	↖	↗	↖	↗	↗	↖
Traffic Vol, veh/h	182	40	40	194	866	408
Future Vol, veh/h	182	40	40	194	866	408
Conflicting Peds, #/hr	0	0	0	0	0	0
Sign Control	Stop	Stop	Free	Free	Free	Free
RT Channelized	-	Stop	-	None	-	None
Storage Length	0	90	70	-	-	100
Veh in Median Storage, #	0	-	-	0	0	-
Grade, %	0	-	-	0	0	-
Peak Hour Factor	95	95	95	95	95	95
Heavy Vehicles, %	2	2	2	2	2	2
Mvmt Flow	192	42	42	204	912	429

Major/Minor	Minor2	Major1	Major2			
Conflicting Flow All	1200	912	1341	0	-	0
Stage 1	912	-	-	-	-	-
Stage 2	288	-	-	-	-	-
Critical Hdwy	6.42	6.22	4.12	-	-	-
Critical Hdwy Stg 1	5.42	-	-	-	-	-
Critical Hdwy Stg 2	5.42	-	-	-	-	-
Follow-up Hdwy	3.518	3.318	2.218	-	-	-
Pot Cap-1 Maneuver	204	332	514	-	-	-
Stage 1	392	-	-	-	-	-
Stage 2	761	-	-	-	-	-
Platoon blocked, %				-	-	-
Mov Cap-1 Maneuver	~ 187	332	514	-	-	-
Mov Cap-2 Maneuver	~ 187	-	-	-	-	-
Stage 1	360	-	-	-	-	-
Stage 2	761	-	-	-	-	-






















Approach	EB	NB	SB
HCM Control Delay, s	104.9	2.2	0
HCM LOS	F		

Minor Lane/Major Mvmt	NBL	NBT	EBLn1	EBLn2	SBT	SBR
Capacity (veh/h)	514	-	187	332	-	-
HCM Lane V/C Ratio	0.082	-	1.024	0.127	-	-
HCM Control Delay (s)	12.6	-	124.1	17.4	-	-
HCM Lane LOS	B	-	F	C	-	-
HCM 95th %tile Q(veh)	0.3	-	8.8	0.4	-	-

Notes  
 -: Volume exceeds capacity    \$: Delay exceeds 300s    +: Computation Not Defined    \*: All major volume in platoon

HCM 6th Signalized Intersection Summary  
5: Fulton Rd & Airport Blvd

Cumulative plus Project Conditions AM

												
Movement	EBL	EBT	EBR	WBL	WBT	WBR	NBL	NBT	NBR	SBL	SBT	SBR
Lane Configurations												
Traffic Volume (veh/h)	81	341	210	232	623	30	720	181	161	40	282	266
Future Volume (veh/h)	81	341	210	232	623	30	720	181	161	40	282	266
Initial Q (Qb), veh	0	0	0	0	0	0	0	0	0	0	0	0
Ped-Bike Adj(A_pbT)	1.00		0.99	1.00		0.99	1.00		0.99	1.00		0.99
Parking Bus, Adj	1.00	1.00	1.00	1.00	1.00	1.00	1.00	1.00	1.00	1.00	1.00	1.00
Work Zone On Approach		No			No			No			No	
Adj Sat Flow, veh/h/ln	1870	1870	1870	1870	1870	1870	1870	1870	1870	1870	1870	1870
Adj Flow Rate, veh/h	85	359	41	244	656	31	758	191	35	42	297	255
Peak Hour Factor	0.95	0.95	0.95	0.95	0.95	0.95	0.95	0.95	0.95	0.95	0.95	0.95
Percent Heavy Veh, %	2	2	2	2	2	2	2	2	2	2	2	2
Cap, veh/h	108	407	341	272	542	26	466	489	410	21	150	129
Arrive On Green	0.06	0.22	0.22	0.15	0.31	0.31	0.26	0.26	0.26	0.17	0.17	0.17
Sat Flow, veh/h	1781	1870	1567	1781	1771	84	1781	1870	1570	122	862	740
Grp Volume(v), veh/h	85	359	41	244	0	687	758	191	35	594	0	0
Grp Sat Flow(s),veh/h/ln	1781	1870	1567	1781	0	1854	1781	1870	1570	1724	0	0
Q Serve(g_s), s	5.4	21.3	2.4	15.4	0.0	35.1	30.0	9.6	1.9	20.0	0.0	0.0
Cycle Q Clear(g_c), s	5.4	21.3	2.4	15.4	0.0	35.1	30.0	9.6	1.9	20.0	0.0	0.0
Prop In Lane	1.00		1.00	1.00		0.05	1.00		1.00	0.07		0.43
Lane Grp Cap(c), veh/h	108	407	341	272	0	567	466	489	410	300	0	0
V/C Ratio(X)	0.79	0.88	0.12	0.90	0.00	1.21	1.63	0.39	0.09	1.98	0.00	0.00
Avail Cap(c_a), veh/h	310	489	409	310	0	567	466	489	410	300	0	0
HCM Platoon Ratio	1.00	1.00	1.00	1.00	1.00	1.00	1.00	1.00	1.00	1.00	1.00	1.00
Upstream Filter(I)	1.00	1.00	1.00	1.00	0.00	1.00	1.00	1.00	1.00	1.00	0.00	0.00
Uniform Delay (d), s/veh	53.2	43.5	36.1	47.7	0.0	39.8	42.4	34.9	32.0	47.4	0.0	0.0
Incr Delay (d2), s/veh	4.7	13.5	0.1	23.3	0.0	110.5	292.4	0.2	0.0	451.9	0.0	0.0
Initial Q Delay(d3),s/veh	0.0	0.0	0.0	0.0	0.0	0.0	0.0	0.0	0.0	0.0	0.0	0.0
%ile BackOfQ(50%),veh/ln	2.5	11.0	0.9	8.5	0.0	32.8	50.4	4.3	0.7	46.1	0.0	0.0
Unsig. Movement Delay, s/veh												
LnGrp Delay(d),s/veh	57.9	57.0	36.1	71.1	0.0	150.4	334.8	35.1	32.1	499.3	0.0	0.0
LnGrp LOS	E	E	D	E	A	F	F	D	C	F	A	A
Approach Vol, veh/h		485			931			984			594	
Approach Delay, s/veh		55.4			129.6			265.8			499.3	
Approach LOS		E			F			F			F	
Timer - Assigned Phs	1	2		4	5	6		8				
Phs Duration (G+Y+Rc), s	22.9	31.0		25.1	12.8	41.1		35.8				
Change Period (Y+Rc), s	5.4	6.0		5.1	5.8	6.0		5.8				
Max Green Setting (Gmax), s	20.0	30.0		20.0	20.0	30.0		30.0				
Max Q Clear Time (g_c+I1), s	17.4	23.3		22.0	7.4	37.1		32.0				
Green Ext Time (p_c), s	0.1	0.7		0.0	0.1	0.0		0.0				

Intersection Summary

HCM 6th Ctrl Delay	235.7
HCM 6th LOS	F

Notes

User approved pedestrian interval to be less than phase max green.



HCM 6th Signalized Intersection Summary  
 6: Old Redwood Hwy & Airport Blvd

Cumulative plus Project Conditions AM



Movement	EBL	EBT	EBR	WBL	WBT	WBR	NBL	NBT	NBR	SBL	SBT	SBR
Lane Configurations												
Traffic Volume (veh/h)	40	160	362	40	311	40	374	204	20	40	856	80
Future Volume (veh/h)	40	160	362	40	311	40	374	204	20	40	856	80
Initial Q (Qb), veh	0	0	0	0	0	0	0	0	0	0	0	0
Ped-Bike Adj(A_pbT)	1.00		0.99	1.00		0.99	1.00		0.99	1.00		0.99
Parking Bus, Adj	1.00	1.00	1.00	1.00	1.00	1.00	1.00	1.00	1.00	1.00	1.00	1.00
Work Zone On Approach		No			No			No			No	
Adj Sat Flow, veh/h/ln	1870	1870	1870	1870	1870	1870	1870	1870	1870	1870	1870	1870
Adj Flow Rate, veh/h	42	168	66	42	327	37	394	215	9	42	901	25
Peak Hour Factor	0.95	0.95	0.95	0.95	0.95	0.95	0.95	0.95	0.95	0.95	0.95	0.95
Percent Heavy Veh, %	2	2	2	2	2	2	2	2	2	2	2	2
Cap, veh/h	53	431	361	53	366	41	375	929	784	53	591	497
Arrive On Green	0.03	0.23	0.23	0.03	0.22	0.22	0.21	0.50	0.50	0.03	0.32	0.32
Sat Flow, veh/h	1781	1870	1568	1781	1649	187	1781	1870	1577	1781	1870	1573
Grp Volume(v), veh/h	42	168	66	42	0	364	394	215	9	42	901	25
Grp Sat Flow(s),veh/h/ln	1781	1870	1568	1781	0	1835	1781	1870	1577	1781	1870	1573
Q Serve(g_s), s	2.2	7.2	3.2	2.2	0.0	18.3	20.0	6.2	0.3	2.2	30.0	1.0
Cycle Q Clear(g_c), s	2.2	7.2	3.2	2.2	0.0	18.3	20.0	6.2	0.3	2.2	30.0	1.0
Prop In Lane	1.00		1.00	1.00		0.10	1.00		1.00	1.00		1.00
Lane Grp Cap(c), veh/h	53	431	361	53	0	408	375	929	784	53	591	497
V/C Ratio(X)	0.79	0.39	0.18	0.79	0.00	0.89	1.05	0.23	0.01	0.79	1.52	0.05
Avail Cap(c_a), veh/h	225	788	661	225	0	503	375	929	784	188	591	497
HCM Platoon Ratio	1.00	1.00	1.00	1.00	1.00	1.00	1.00	1.00	1.00	1.00	1.00	1.00
Upstream Filter(I)	1.00	1.00	1.00	1.00	0.00	1.00	1.00	1.00	1.00	1.00	1.00	1.00
Uniform Delay (d), s/veh	45.8	30.9	29.3	45.7	0.0	35.8	37.5	13.6	12.1	45.8	32.5	22.6
Incr Delay (d2), s/veh	9.3	0.2	0.1	9.2	0.0	14.0	60.1	0.0	0.0	9.3	244.5	0.0
Initial Q Delay(d3),s/veh	0.0	0.0	0.0	0.0	0.0	0.0	0.0	0.0	0.0	0.0	0.0	0.0
%ile BackOfQ(50%),veh/ln	1.1	3.2	1.2	1.1	0.0	9.7	14.7	2.5	0.1	1.1	53.0	0.4
Unsig. Movement Delay, s/veh												
LnGrp Delay(d),s/veh	55.1	31.1	29.4	54.9	0.0	49.8	97.6	13.6	12.1	55.1	276.9	22.6
LnGrp LOS	E	C	C	D	A	D	F	B	B	E	F	C
Approach Vol, veh/h		276			406			618			968	
Approach Delay, s/veh		34.3			50.3			67.1			260.7	
Approach LOS		C			D			E			F	
Timer - Assigned Phs	1	2	3	4	5	6	7	8				
Phs Duration (G+Y+Rc), s	7.4	27.3	25.1	35.1	8.2	26.5	7.9	52.3				
Change Period (Y+Rc), s	4.6	5.4	5.1	5.1	5.4	* 5.4	5.1	5.1				
Max Green Setting (Gmax)	12.0	40.0	20.0	30.0	12.0	* 26	10.0	30.0				
Max Q Clear Time (g_c+1)	11.2	9.2	22.0	32.0	4.2	20.3	4.2	8.2				
Green Ext Time (p_c), s	0.0	0.3	0.0	0.0	0.0	0.5	0.0	0.4				

Intersection Summary

HCM 6th Ctrl Delay	142.8
HCM 6th LOS	F

Notes

- User approved pedestrian interval to be less than phase max green.
- \* HCM 6th computational engine requires equal clearance times for the phases crossing the barrier.

HCM 6th TWSC

7: Old Redwood Hwy & Creekside Apts/Faught Rd

Cumulative plus Project Conditions AM

Intersection												
Int Delay, s/veh	275											
Movement	EBL	EBT	EBR	WBL	WBT	WBR	NBL	NBT	NBR	SBL	SBT	SBR
Lane Configurations		↕			↕		↕	↑	↑	↑		↕
Traffic Vol, veh/h	60	20	30	182	20	20	20	437	110	30	1108	30
Future Vol, veh/h	60	20	30	182	20	20	20	437	110	30	1108	30
Conflicting Peds, #/hr	0	0	0	0	0	0	0	0	0	0	0	0
Sign Control	Stop	Stop	Stop	Stop	Stop	Stop	Free	Free	Free	Free	Free	Free
RT Channelized	-	-	None	-	-	None	-	-	None	-	-	None
Storage Length	-	-	-	-	-	-	50	-	270	-	-	-
Veh in Median Storage, #	-	0	-	-	0	-	-	0	-	-	0	-
Grade, %	-	0	-	-	0	-	-	0	-	-	0	-
Peak Hour Factor	95	95	95	95	95	95	95	95	95	95	95	95
Heavy Vehicles, %	2	2	2	2	2	2	2	2	2	2	2	2
Mvmt Flow	63	21	32	192	21	21	21	460	116	32	1166	32

Major/Minor	Minor2		Minor1		Major1			Major2				
Conflicting Flow All	1827	1864	1182	1775	1764	460	1198	0	0	576	0	0
Stage 1	1246	1246	-	502	502	-	-	-	-	-	-	-
Stage 2	581	618	-	1273	1262	-	-	-	-	-	-	-
Critical Hdwy	7.12	6.52	6.22	7.12	6.52	6.22	4.12	-	-	4.12	-	-
Critical Hdwy Stg 1	6.12	5.52	-	6.12	5.52	-	-	-	-	-	-	-
Critical Hdwy Stg 2	6.12	5.52	-	6.12	5.52	-	-	-	-	-	-	-
Follow-up Hdwy	3.518	4.018	3.318	3.518	4.018	3.318	2.218	-	-	2.218	-	-
Pot Cap-1 Maneuver	~ 59	73	231	~ 64	84	601	583	-	-	997	-	-
Stage 1	213	246	-	552	542	-	-	-	-	-	-	-
Stage 2	499	481	-	205	241	-	-	-	-	-	-	-
Platoon blocked, %								-	-	-	-	-
Mov Cap-1 Maneuver	~ 40	64	231	~ 37	73	601	583	-	-	997	-	-
Mov Cap-2 Maneuver	~ 40	64	-	~ 37	73	-	-	-	-	-	-	-
Stage 1	205	222	-	532	522	-	-	-	-	-	-	-
Stage 2	445	464	-	~ 145	218	-	-	-	-	-	-	-

Approach	EB		WB		NB		SB	
HCM Control Delay, s\$	634.3		\$ 2244.1		0.4		0.2	
HCM LOS	F		F					






















Minor Lane/Major Mvmt	NBL	NBT	NBR	EBLn1	WBLn1	SBL	SBT	SBR
Capacity (veh/h)	583	-	-	57	42	997	-	-
HCM Lane V/C Ratio	0.036	-	-	2.031	5.564	0.032	-	-
HCM Control Delay (s)	11.4	-	-	\$ 634.3	\$ 2244.1	8.7	0	-
HCM Lane LOS	B	-	-	F	F	A	A	-
HCM 95th %tile Q(veh)	0.1	-	-	11.2	27.2	0.1	-	-

Notes  
 -: Volume exceeds capacity    \$: Delay exceeds 300s    +: Computation Not Defined    \*: All major volume in platoon

# HCM 6th Signalized Intersection Summary

## 8: Old Redwood Hwy & Mark West Commons Cir/Wikiup Dr

Cumulative plus Project Conditions AM

												
Movement	EBL	EBT	EBR	WBL	WBT	WBR	NBL	NBT	NBR	SBL	SBT	SBR
Lane Configurations												
Traffic Volume (veh/h)	30	20	30	209	20	57	20	411	154	244	956	20
Future Volume (veh/h)	30	20	30	209	20	57	20	411	154	244	956	20
Initial Q (Qb), veh	0	0	0	0	0	0	0	0	0	0	0	0
Ped-Bike Adj(A_pbT)	0.99		0.99	0.99		0.99	1.00		0.99	1.00		0.99
Parking Bus, Adj	1.00	1.00	1.00	1.00	1.00	1.00	1.00	1.00	1.00	1.00	1.00	1.00
Work Zone On Approach		No			No			No			No	
Adj Sat Flow, veh/h/ln	1870	1870	1870	1870	1870	1870	1870	1870	1870	1870	1870	1870
Adj Flow Rate, veh/h	32	21	7	220	21	13	21	433	51	257	1006	10
Peak Hour Factor	0.95	0.95	0.95	0.95	0.95	0.95	0.95	0.95	0.95	0.95	0.95	0.95
Percent Heavy Veh, %	2	2	2	2	2	2	2	2	2	2	2	2
Cap, veh/h	128	71	14	379	26	403	35	624	525	304	907	764
Arrive On Green	0.26	0.26	0.26	0.26	0.26	0.26	0.02	0.33	0.33	0.17	0.48	0.48
Sat Flow, veh/h	149	276	56	1043	100	1570	1781	1870	1573	1781	1870	1577
Grp Volume(v), veh/h	60	0	0	241	0	13	21	433	51	257	1006	10
Grp Sat Flow(s),veh/h/ln	481	0	0	1143	0	1570	1781	1870	1573	1781	1870	1577
Q Serve(g_s), s	0.5	0.0	0.0	0.0	0.0	0.4	0.7	12.4	1.4	8.7	30.0	0.2
Cycle Q Clear(g_c), s	13.4	0.0	0.0	13.0	0.0	0.4	0.7	12.4	1.4	8.7	30.0	0.2
Prop In Lane	0.53		0.12	0.91		1.00	1.00		1.00	1.00		1.00
Lane Grp Cap(c), veh/h	213	0	0	405	0	403	35	624	525	304	907	764
V/C Ratio(X)	0.28	0.00	0.00	0.60	0.00	0.03	0.60	0.69	0.10	0.85	1.11	0.01
Avail Cap(c_a), veh/h	213	0	0	612	0	634	345	907	762	345	907	764
HCM Platoon Ratio	1.00	1.00	1.00	1.00	1.00	1.00	1.00	1.00	1.00	1.00	1.00	1.00
Upstream Filter(I)	1.00	0.00	0.00	1.00	0.00	1.00	1.00	1.00	1.00	1.00	1.00	1.00
Uniform Delay (d), s/veh	18.7	0.0	0.0	21.9	0.0	17.2	30.1	17.9	14.2	24.9	15.9	8.3
Incr Delay (d2), s/veh	0.3	0.0	0.0	0.5	0.0	0.0	6.0	0.5	0.0	14.2	64.7	0.0
Initial Q Delay(d3),s/veh	0.0	0.0	0.0	0.0	0.0	0.0	0.0	0.0	0.0	0.0	0.0	0.0
%ile BackOfQ(50%),veh/ln	0.6	0.0	0.0	3.2	0.0	0.1	0.4	4.8	0.4	4.5	26.4	0.1
Unsig. Movement Delay, s/veh												
LnGrp Delay(d),s/veh	19.0	0.0	0.0	22.5	0.0	17.3	36.1	18.4	14.2	39.1	80.7	8.3
LnGrp LOS	B	A	A	C	A	B	D	B	B	D	F	A
Approach Vol, veh/h		60			254			505			1273	
Approach Delay, s/veh		19.0			22.2			18.7			71.7	
Approach LOS		B			C			B			E	
Timer - Assigned Phs		2	3	4		6	7	8				
Phs Duration (G+Y+Rc), s		20.5	6.3	35.1		20.5	15.7	25.7				
Change Period (Y+Rc), s		4.6	5.1	5.1		4.6	5.1	5.1				
Max Green Setting (Gmax), s		12.0	12.0	30.0		25.0	12.0	30.0				
Max Q Clear Time (g_c+I1), s		15.4	2.7	32.0		15.0	10.7	14.4				
Green Ext Time (p_c), s		0.0	0.0	0.0		0.7	0.0	1.2				
<b>Intersection Summary</b>												
HCM 6th Ctrl Delay			51.4									
HCM 6th LOS			D									
<b>Notes</b>												
User approved pedestrian interval to be less than phase max green.												

**Intersection**

Int Delay, s/veh 143.7

Movement	EBL	EBT	WBT	WBR	SBL	SBR
Lane Configurations		↕	↑	↗	↖	↗
Traffic Vol, veh/h	105	375	225	236	512	43
Future Vol, veh/h	105	375	225	236	512	43
Conflicting Peds, #/hr	0	0	0	0	0	0
Sign Control	Free	Free	Free	Free	Stop	Stop
RT Channelized	-	None	-	Yield	-	None
Storage Length	-	-	-	150	90	0
Veh in Median Storage, #	-	0	0	-	0	-
Grade, %	-	0	0	-	0	-
Peak Hour Factor	95	95	95	95	95	95
Heavy Vehicles, %	2	2	2	2	2	2
Mvmt Flow	111	395	237	248	539	45

Major/Minor	Major1	Major2	Minor2
Conflicting Flow All	237	0	854
Stage 1	-	-	237
Stage 2	-	-	617
Critical Hdwy	4.12	-	6.42
Critical Hdwy Stg 1	-	-	5.42
Critical Hdwy Stg 2	-	-	5.42
Follow-up Hdwy	2.218	-	3.518
Pot Cap-1 Maneuver	1330	-	~ 329
Stage 1	-	-	802
Stage 2	-	-	~ 538
Platoon blocked, %	-	-	-
Mov Cap-1 Maneuver	1330	-	~ 294
Mov Cap-2 Maneuver	-	-	~ 294
Stage 1	-	-	716
Stage 2	-	-	~ 538




















Approach	EB	WB	SB
HCM Control Delay, s	1.7	0	\$ 385.8
HCM LOS			F

Minor Lane/Major Mvmt	EBL	EBT	WBT	WBR	SBLn1	SBLn2
Capacity (veh/h)	1330	-	-	-	294	802
HCM Lane V/C Ratio	0.083	-	-	-	1.833	0.056
HCM Control Delay (s)	8	0	-	-	\$ 417.4	9.8
HCM Lane LOS	A	A	-	-	F	A
HCM 95th %tile Q(veh)	0.3	-	-	-	36.2	0.2

**Notes**  
 -: Volume exceeds capacity    \$: Delay exceeds 300s    +: Computation Not Defined    \*: All major volume in platoon

HCM 6th Signalized Intersection Summary  
 10: Gravenstein Hwy & Graton Rd/Frei Rd

Cumulative plus Project Conditions AM

												
Movement	EBL	EBT	EBR	WBL	WBT	WBR	NBL	NBT	NBR	SBL	SBT	SBR
Lane Configurations												
Traffic Volume (veh/h)	50	81	204	140	71	20	113	450	170	21	555	40
Future Volume (veh/h)	50	81	204	140	71	20	113	450	170	21	555	40
Initial Q (Qb), veh	0	0	0	0	0	0	0	0	0	0	0	0
Ped-Bike Adj(A_pbT)	0.99		0.99	0.99		0.99	1.00		0.99	1.00		0.99
Parking Bus, Adj	1.00	1.00	1.00	1.00	1.00	1.00	1.00	1.00	1.00	1.00	1.00	1.00
Work Zone On Approach		No			No			No			No	
Adj Sat Flow, veh/h/ln	1870	1870	1870	1870	1870	1870	1870	1870	1870	1870	1870	1870
Adj Flow Rate, veh/h	53	85	34	147	75	19	119	474	174	22	584	40
Peak Hour Factor	0.95	0.95	0.95	0.95	0.95	0.95	0.95	0.95	0.95	0.95	0.95	0.95
Percent Heavy Veh, %	2	2	2	2	2	2	2	2	2	2	2	2
Cap, veh/h	188	270	371	237	106	22	286	605	222	107	630	43
Arrive On Green	0.24	0.24	0.24	0.24	0.24	0.24	0.16	0.46	0.46	0.06	0.36	0.36
Sat Flow, veh/h	478	1140	1568	636	447	93	1781	1303	478	1781	1730	118
Grp Volume(v), veh/h	138	0	34	241	0	0	119	0	648	22	0	624
Grp Sat Flow(s),veh/h/ln	1619	0	1568	1176	0	0	1781	0	1781	1781	0	1848
Q Serve(g_s), s	0.0	0.0	1.1	9.4	0.0	0.0	4.0	0.0	20.4	0.8	0.0	21.6
Cycle Q Clear(g_c), s	4.3	0.0	1.1	13.7	0.0	0.0	4.0	0.0	20.4	0.8	0.0	21.6
Prop In Lane	0.38		1.00	0.61		0.08	1.00		0.27	1.00		0.06
Lane Grp Cap(c), veh/h	458	0	371	365	0	0	286	0	827	107	0	673
V/C Ratio(X)	0.30	0.00	0.09	0.66	0.00	0.00	0.42	0.00	0.78	0.20	0.00	0.93
Avail Cap(c_a), veh/h	1281	0	1179	371	0	0	429	0	1339	1340	0	695
HCM Platoon Ratio	1.00	1.00	1.00	1.00	1.00	1.00	1.00	1.00	1.00	1.00	1.00	1.00
Upstream Filter(I)	1.00	0.00	1.00	1.00	0.00	0.00	1.00	0.00	1.00	1.00	0.00	1.00
Uniform Delay (d), s/veh	20.9	0.0	19.8	25.6	0.0	0.0	25.1	0.0	15.0	29.7	0.0	20.3
Incr Delay (d2), s/veh	0.4	0.0	0.1	4.2	0.0	0.0	1.0	0.0	1.7	0.9	0.0	18.4
Initial Q Delay(d3),s/veh	0.0	0.0	0.0	0.0	0.0	0.0	0.0	0.0	0.0	0.0	0.0	0.0
%ile BackOfQ(50%),veh/ln	1.7	0.0	0.4	3.8	0.0	0.0	1.6	0.0	6.8	0.3	0.0	11.1
Unsig. Movement Delay, s/veh												
LnGrp Delay(d),s/veh	21.3	0.0	19.9	29.8	0.0	0.0	26.1	0.0	16.7	30.7	0.0	38.7
LnGrp LOS	C	A	B	C	A	A	C	A	B	C	A	D
Approach Vol, veh/h		172			241			767			646	
Approach Delay, s/veh		21.0			29.8			18.1			38.4	
Approach LOS		C			C			B			D	
Timer - Assigned Phs	1	2		4	5	6		8				
Phs Duration (G+Y+Rc), s	15.4	30.0		21.1	8.7	36.7		21.1				
Change Period (Y+Rc), s	* 4.7	5.8		5.4	* 4.7	5.8		5.4				
Max Green Setting (Gmax), s	* 16	25.0		16.0	* 50	50.0		50.0				
Max Q Clear Time (g_c+I1), s	6.0	23.6		15.7	2.8	22.4		6.3				
Green Ext Time (p_c), s	0.2	0.6		0.0	0.0	4.4		0.9				
<b>Intersection Summary</b>												
HCM 6th Ctrl Delay			27.1									
HCM 6th LOS			C									
<b>Notes</b>												
User approved pedestrian interval to be less than phase max green.												
* HCM 6th computational engine requires equal clearance times for the phases crossing the barrier.												

HCM 6th TWSC  
 11: Private Dwy/Moorland Ave & Todd Rd

Cumulative plus Project Conditions AM

Intersection												
Int Delay, s/veh	544.5											
Movement	EBL	EBT	EBR	WBL	WBT	WBR	NBL	NBT	NBR	SBL	SBT	SBR
Lane Configurations	↖	↗		↖	↗			↕			↖	↗
Traffic Vol, veh/h	72	549	20	20	535	409	20	20	20	385	20	92
Future Vol, veh/h	72	549	20	20	535	409	20	20	20	385	20	92
Conflicting Peds, #/hr	0	0	0	0	0	0	0	0	0	0	0	0
Sign Control	Free	Free	Free	Free	Free	Free	Stop	Stop	Stop	Stop	Stop	Stop
RT Channelized	-	-	None	-	-	None	-	-	None	-	-	None
Storage Length	100	-	-	70	-	-	-	-	-	-	-	60
Veh in Median Storage, #	-	0	-	-	0	-	-	0	-	-	0	-
Grade, %	-	0	-	-	0	-	-	0	-	-	0	-
Peak Hour Factor	95	95	95	95	95	95	95	95	95	95	95	95
Heavy Vehicles, %	2	2	2	2	2	2	2	2	2	2	2	2
Mvmt Flow	76	578	21	21	563	431	21	21	21	405	21	97

Major/Minor	Major1			Major2			Minor1			Minor2		
Conflicting Flow All	994	0	0	599	0	0	1621	1777	589	1583	1572	779
Stage 1	-	-	-	-	-	-	741	741	-	821	821	-
Stage 2	-	-	-	-	-	-	880	1036	-	762	751	-
Critical Hdwy	4.12	-	-	4.12	-	-	7.12	6.52	6.22	7.12	6.52	6.22
Critical Hdwy Stg 1	-	-	-	-	-	-	6.12	5.52	-	6.12	5.52	-
Critical Hdwy Stg 2	-	-	-	-	-	-	6.12	5.52	-	6.12	5.52	-
Follow-up Hdwy	2.218	-	-	2.218	-	-	3.518	4.018	3.318	3.518	4.018	3.318
Pot Cap-1 Maneuver	696	-	-	978	-	-	83	82	508	~ 88	110	396
Stage 1	-	-	-	-	-	-	408	423	-	~ 369	389	-
Stage 2	-	-	-	-	-	-	342	309	-	~ 397	418	-
Platoon blocked, %		-	-	-	-	-						
Mov Cap-1 Maneuver	696	-	-	978	-	-	47	72	508	~ 59	96	396
Mov Cap-2 Maneuver	-	-	-	-	-	-	47	72	-	~ 59	96	-
Stage 1	-	-	-	-	-	-	364	377	-	~ 329	381	-
Stage 2	-	-	-	-	-	-	239	303	-	~ 320	372	-

Approach	EB			WB			NB			SB		
HCM Control Delay, s	1.2			0.2			134.2			\$ 2350.4		
HCM LOS							F			F		





















Minor Lane/Major Mvmt	NBLn1	EBL	EBT	EBR	WBL	WBT	WBR	SBLn1	SBLn2
Capacity (veh/h)	81	696	-	-	978	-	-	60	396
HCM Lane V/C Ratio	0.78	0.109	-	-	0.022	-	-	7.105	0.245
HCM Control Delay (s)	134.2	10.8	-	-	8.8	-	-	\$ 2880.5	17
HCM Lane LOS	F	B	-	-	A	-	-	F	C
HCM 95th %tile Q(veh)	3.9	0.4	-	-	0.1	-	-	49	0.9

Notes  
 -: Volume exceeds capacity    \$: Delay exceeds 300s    +: Computation Not Defined    \*: All major volume in platoon

# HCM 6th Signalized Intersection Summary

## 12: S Moreland Ave & Todd Rd

Cumulative plus Project Conditions AM

												
Movement	EBL	EBT	EBR	WBL	WBT	WBR	NBL	NBT	NBR	SBL	SBT	SBR
Lane Configurations												
Traffic Volume (veh/h)	0	530	424	420	337	0	627	0	207	0	0	0
Future Volume (veh/h)	0	530	424	420	337	0	627	0	207	0	0	0
Initial Q (Qb), veh	0	0	0	0	0	0	0	0	0	0	0	0
Ped-Bike Adj(A_pbT)	1.00		1.00	1.00		1.00	1.00		1.00	1.00		1.00
Parking Bus, Adj	1.00	1.00	1.00	1.00	1.00	1.00	1.00	1.00	1.00	1.00	1.00	1.00
Work Zone On Approach		No			No			No			No	
Adj Sat Flow, veh/h/ln	1870	1870	1870	1870	1870	1870	1870	1870	1870	1870	1870	1870
Adj Flow Rate, veh/h	0	558	265	442	355	0	660	0	139	0	0	0
Peak Hour Factor	0.95	0.95	0.95	0.95	0.95	0.95	0.95	0.95	0.95	0.95	0.95	0.95
Percent Heavy Veh, %	2	2	2	2	2	2	2	2	2	2	2	2
Cap, veh/h	0	488	413	523	549	0	580	0	1033	0	2	0
Arrive On Green	0.00	0.26	0.26	0.29	0.29	0.00	0.33	0.00	0.33	0.00	0.00	0.00
Sat Flow, veh/h	0	1870	1585	1781	1870	0	1781	0	3170	0	1870	0
Grp Volume(v), veh/h	0	558	265	442	355	0	660	0	139	0	0	0
Grp Sat Flow(s),veh/h/ln	0	1870	1585	1781	1870	0	1781	0	1585	0	1870	0
Q Serve(g_s), s	0.0	20.0	11.4	17.9	12.7	0.0	25.0	0.0	2.4	0.0	0.0	0.0
Cycle Q Clear(g_c), s	0.0	20.0	11.4	17.9	12.7	0.0	25.0	0.0	2.4	0.0	0.0	0.0
Prop In Lane	0.00		1.00	1.00		0.00	1.00		1.00	0.00		0.00
Lane Grp Cap(c), veh/h	0	488	413	523	549	0	580	0	1033	0	2	0
V/C Ratio(X)	0.00	1.14	0.64	0.85	0.65	0.00	1.14	0.00	0.13	0.00	0.00	0.00
Avail Cap(c_a), veh/h	0	488	413	696	731	0	580	0	1033	0	195	0
HCM Platoon Ratio	1.00	1.00	1.00	1.00	1.00	1.00	1.00	1.00	1.00	1.00	1.00	1.00
Upstream Filter(I)	0.00	1.00	1.00	1.00	1.00	0.00	1.00	0.00	1.00	0.00	0.00	0.00
Uniform Delay (d), s/veh	0.0	28.4	25.2	25.5	23.6	0.0	25.9	0.0	18.2	0.0	0.0	0.0
Incr Delay (d2), s/veh	0.0	86.9	3.3	7.3	1.3	0.0	81.3	0.0	0.1	0.0	0.0	0.0
Initial Q Delay(d3),s/veh	0.0	0.0	0.0	0.0	0.0	0.0	0.0	0.0	0.0	0.0	0.0	0.0
%ile BackOfQ(50%),veh/ln	0.0	20.1	4.4	8.1	5.4	0.0	23.0	0.0	0.8	0.0	0.0	0.0
Unsig. Movement Delay, s/veh												
LnGrp Delay(d),s/veh	0.0	115.3	28.5	32.7	24.9	0.0	107.1	0.0	18.3	0.0	0.0	0.0
LnGrp LOS	A	F	C	C	C	A	F	A	B	A	A	A
Approach Vol, veh/h		823			797			799				0
Approach Delay, s/veh		87.3			29.2			91.7				0.0
Approach LOS		F			C			F				
Timer - Assigned Phs		2		4		6			8			
Phs Duration (G+Y+Rc), s		0.0		23.2		28.0			25.5			
Change Period (Y+Rc), s		3.0		3.2		3.0			3.0			
Max Green Setting (Gmax), s		8.0		20.0		25.0			30.0			
Max Q Clear Time (g_c+I1), s		0.0		22.0		27.0			19.9			
Green Ext Time (p_c), s		0.0		0.0		0.0			2.6			

### Intersection Summary

HCM 6th Ctrl Delay 69.6  
 HCM 6th LOS E

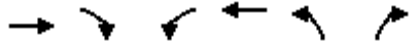
### Notes

User approved pedestrian interval to be less than phase max green.  
 User approved volume balancing among the lanes for turning movement.

# HCM 6th Signalized Intersection Summary

## 13: Todd Rd Overpass & Todd Rd

Cumulative plus Project Conditions AM



Movement	EBT	EBR	WBL	WBT	NBL	NBR
Lane Configurations	↑↑	↗	↖	↑↑	↖	↗↗
Traffic Volume (veh/h)	256	280	484	336	267	537
Future Volume (veh/h)	256	280	484	336	267	537
Initial Q (Qb), veh	0	0	0	0	0	0
Ped-Bike Adj(A_pbT)		1.00	1.00		1.00	1.00
Parking Bus, Adj	1.00	1.00	1.00	1.00	1.00	1.00
Work Zone On Approach	No			No	No	
Adj Sat Flow, veh/h/ln	1870	1870	1870	1870	1870	1870
Adj Flow Rate, veh/h	269	52	509	354	281	303
Peak Hour Factor	0.95	0.95	0.95	0.95	0.95	0.95
Percent Heavy Veh, %	2	2	2	2	2	2
Cap, veh/h	586	261	1050	551	423	1485
Arrive On Green	0.16	0.16	0.29	0.29	0.24	0.24
Sat Flow, veh/h	3647	1585	3563	1870	1781	2790
Grp Volume(v), veh/h	269	52	509	354	281	303
Grp Sat Flow(s),veh/h/ln	1777	1585	1781	1870	1781	1395
Q Serve(g_s), s	2.4	1.0	4.1	5.7	5.0	2.0
Cycle Q Clear(g_c), s	2.4	1.0	4.1	5.7	5.0	2.0
Prop In Lane		1.00	1.00		1.00	1.00
Lane Grp Cap(c), veh/h	586	261	1050	551	423	1485
V/C Ratio(X)	0.46	0.20	0.48	0.64	0.66	0.20
Avail Cap(c_a), veh/h	2049	914	1540	809	719	1948
HCM Platoon Ratio	1.00	1.00	1.00	1.00	1.00	1.00
Upstream Filter(I)	1.00	1.00	1.00	1.00	1.00	1.00
Uniform Delay (d), s/veh	13.1	12.5	10.1	10.6	12.0	4.3
Incr Delay (d2), s/veh	0.6	0.4	0.3	1.3	1.8	0.1
Initial Q Delay(d3),s/veh	0.0	0.0	0.0	0.0	0.0	0.0
%ile BackOfQ(50%),veh/ln	0.8	0.3	1.2	1.9	1.7	0.8
Unsig. Movement Delay, s/veh						
LnGrp Delay(d),s/veh	13.6	12.9	10.4	11.9	13.8	4.3
LnGrp LOS	B	B	B	B	B	A
Approach Vol, veh/h	321			863	584	
Approach Delay, s/veh	13.5			11.0	8.9	
Approach LOS	B			B	A	
Timer - Assigned Phs		2			6	8
Phs Duration (G+Y+Rc), s		9.2			13.7	11.7
Change Period (Y+Rc), s		3.5			3.5	3.5
Max Green Setting (Gmax), s		20.0			15.0	14.0
Max Q Clear Time (g_c+I1), s		4.4			7.7	7.0
Green Ext Time (p_c), s		1.6			2.5	1.3
<b>Intersection Summary</b>						
HCM 6th Ctrl Delay			10.8			
HCM 6th LOS			B			
<b>Notes</b>						
User approved volume balancing among the lanes for turning movement.						



# HCM 6th Signalized Intersection Summary

## 14: Santa Rosa Ave & Todd Rd

Cumulative plus Project Conditions AM



Movement	EBL	EBT	EBR	WBL	WBT	WBR	NBL	NBT	NBR	SBL	SBT	SBR
Lane Configurations	↘	↖	↗	↘	↖		↘	↑↑	↗	↘	↑↑	↗
Traffic Volume (veh/h)	370	120	303	30	40	40	409	741	50	60	375	371
Future Volume (veh/h)	370	120	303	30	40	40	409	741	50	60	375	371
Initial Q (Qb), veh	0	0	0	0	0	0	0	0	0	0	0	0
Ped-Bike Adj(A_pbT)	1.00		0.99	1.00		1.00	1.00		0.99	1.00		0.99
Parking Bus, Adj	1.00	1.00	1.00	1.00	1.00	1.00	1.00	1.00	1.00	1.00	1.00	1.00
Work Zone On Approach		No			No			No			No	
Adj Sat Flow, veh/h/ln	1870	1870	1870	1870	1870	1870	1870	1870	1870	1870	1870	1870
Adj Flow Rate, veh/h	258	310	56	32	42	1	431	780	19	63	395	70
Peak Hour Factor	0.95	0.95	0.95	0.95	0.95	0.95	0.95	0.95	0.95	0.95	0.95	0.95
Percent Heavy Veh, %	2	2	2	2	2	2	2	2	2	2	2	2
Cap, veh/h	365	383	322	82	84	2	473	1331	590	80	563	249
Arrive On Green	0.20	0.20	0.20	0.05	0.05	0.05	0.27	0.37	0.37	0.04	0.16	0.16
Sat Flow, veh/h	1781	1870	1573	1781	1819	43	1781	3554	1574	1781	3554	1570
Grp Volume(v), veh/h	258	310	56	32	0	43	431	780	19	63	395	70
Grp Sat Flow(s),veh/h/ln	1781	1870	1573	1781	0	1863	1781	1777	1574	1781	1777	1570
Q Serve(g_s), s	8.6	10.1	1.9	1.1	0.0	1.4	14.9	11.2	0.5	2.2	6.7	2.5
Cycle Q Clear(g_c), s	8.6	10.1	1.9	1.1	0.0	1.4	14.9	11.2	0.5	2.2	6.7	2.5
Prop In Lane	1.00		1.00	1.00		0.02	1.00		1.00	1.00		1.00
Lane Grp Cap(c), veh/h	365	383	322	82	0	86	473	1331	590	80	563	249
V/C Ratio(X)	0.71	0.81	0.17	0.39	0.00	0.50	0.91	0.59	0.03	0.79	0.70	0.28
Avail Cap(c_a), veh/h	504	529	445	280	0	293	476	1339	593	280	893	395
HCM Platoon Ratio	1.00	1.00	1.00	1.00	1.00	1.00	1.00	1.00	1.00	1.00	1.00	1.00
Upstream Filter(I)	1.00	1.00	1.00	1.00	0.00	1.00	1.00	1.00	1.00	1.00	1.00	1.00
Uniform Delay (d), s/veh	23.6	24.1	20.9	29.5	0.0	29.7	22.6	16.0	12.6	30.1	25.4	23.6
Incr Delay (d2), s/veh	1.2	4.5	0.1	1.1	0.0	1.7	21.0	0.4	0.0	6.4	0.6	0.2
Initial Q Delay(d3),s/veh	0.0	0.0	0.0	0.0	0.0	0.0	0.0	0.0	0.0	0.0	0.0	0.0
%ile BackOfQ(50%),veh/ln	3.5	4.6	0.6	0.5	0.0	0.7	8.4	4.1	0.2	1.0	2.6	0.9
Unsig. Movement Delay, s/veh												
LnGrp Delay(d),s/veh	24.8	28.7	21.0	30.6	0.0	31.3	43.7	16.4	12.6	36.5	26.0	23.8
LnGrp LOS	C	C	C	C	A	C	D	B	B	D	C	C
Approach Vol, veh/h		624			75			1230			528	
Approach Delay, s/veh		26.4			31.0			25.9			26.9	
Approach LOS		C			C			C			C	
Timer - Assigned Phs		2	3	4		6	7	8				
Phs Duration (G+Y+Rc), s		18.1	22.0	15.5		8.0	8.3	29.3				
Change Period (Y+Rc), s		5.1	5.1	5.4		5.1	5.4	* 5.4				
Max Green Setting (Gmax), s		18.0	17.0	16.0		10.0	10.0	* 24				
Max Q Clear Time (g_c+I1), s		12.1	16.9	8.7		3.4	4.2	13.2				
Green Ext Time (p_c), s		0.7	0.0	0.8		0.0	0.0	2.2				

### Intersection Summary

HCM 6th Ctrl Delay	26.4
HCM 6th LOS	C

### Notes

- User approved pedestrian interval to be less than phase max green.
- User approved volume balancing among the lanes for turning movement.
- \* HCM 6th computational engine requires equal clearance times for the phases crossing the barrier.

HCM 6th AWSC  
 15: Arnold Dr & Warm Springs Rd/Private Dwy

Cumulative plus Project Conditions AM

Intersection

Intersection Delay, s/veh 13.7

Intersection LOS B

Movement	EBL	EBT	EBR	WBL	WBT	WBR	NBL	NBT	NBR	SBL	SBT	SBR
Lane Configurations		↕			↕			↕			↕	
Traffic Vol, veh/h	50	20	271	20	20	20	142	132	20	20	221	50
Future Vol, veh/h	50	20	271	20	20	20	142	132	20	20	221	50
Peak Hour Factor	0.95	0.95	0.95	0.95	0.95	0.95	0.95	0.95	0.95	0.95	0.95	0.95
Heavy Vehicles, %	2	2	2	2	2	2	2	2	2	2	2	2
Mvmt Flow	53	21	285	21	21	21	149	139	21	21	233	53
Number of Lanes	0	1	0	0	1	0	0	1	0	0	1	0

Approach	EB	WB	NB	SB
Opposing Approach	WB	EB	SB	NB
Opposing Lanes	1	1	1	1
Conflicting Approach Left SB		NB	EB	WB
Conflicting Lanes Left	1	1	1	1
Conflicting Approach Right NB		SB	WB	EB
Conflicting Lanes Right	1	1	1	1
HCM Control Delay	14.2	10.1	14.1	13.6
HCM LOS	B	B	B	B

Lane	NBLn1	EBLn1	WBLn1	SBLn1
Vol Left, %	48%	15%	33%	7%
Vol Thru, %	45%	6%	33%	76%
Vol Right, %	7%	79%	33%	17%
Sign Control	Stop	Stop	Stop	Stop
Traffic Vol by Lane	294	341	60	291
LT Vol	142	50	20	20
Through Vol	132	20	20	221
RT Vol	20	271	20	50
Lane Flow Rate	309	359	63	306
Geometry Grp	1	1	1	1
Degree of Util (X)	0.489	0.528	0.109	0.473
Departure Headway (Hd)	5.687	5.3	6.208	5.558
Convergence, Y/N	Yes	Yes	Yes	Yes
Cap	631	675	572	646
Service Time	3.752	3.366	4.303	3.623
HCM Lane V/C Ratio	0.49	0.532	0.11	0.474
HCM Control Delay	14.1	14.2	10.1	13.6
HCM Lane LOS	B	B	B	B
HCM 95th-tile Q	2.7	3.1	0.4	2.5

HCM 6th TWSC  
16: Riverside Dr & Verano Ave

Cumulative plus Project Conditions AM

Intersection												
Int Delay, s/veh	38.8											
Movement	EBL	EBT	EBR	WBL	WBT	WBR	NBL	NBT	NBR	SBL	SBT	SBR
Lane Configurations												
Traffic Vol, veh/h	52	300	20	100	290	62	30	30	30	147	30	57
Future Vol, veh/h	52	300	20	100	290	62	30	30	30	147	30	57
Conflicting Peds, #/hr	0	0	0	0	0	0	0	0	0	0	0	0
Sign Control	Free	Free	Free	Free	Free	Free	Stop	Stop	Stop	Stop	Stop	Stop
RT Channelized	-	-	None	-	-	None	-	-	None	-	-	None
Storage Length	100	-	-	-	-	-	-	-	-	-	-	-
Veh in Median Storage, #	-	0	-	-	0	-	-	0	-	-	0	-
Grade, %	-	0	-	-	0	-	-	0	-	-	0	-
Peak Hour Factor	95	95	95	95	95	95	95	95	95	95	95	95
Heavy Vehicles, %	2	2	2	2	2	2	2	2	2	2	2	2
Mvmt Flow	55	316	21	105	305	65	32	32	32	155	32	60

Major/Minor	Major1			Major2			Minor1			Minor2		
Conflicting Flow All	370	0	0	337	0	0	1031	1017	327	1017	995	338
Stage 1	-	-	-	-	-	-	437	437	-	548	548	-
Stage 2	-	-	-	-	-	-	594	580	-	469	447	-
Critical Hdwy	4.12	-	-	4.12	-	-	7.12	6.52	6.22	7.12	6.52	6.22
Critical Hdwy Stg 1	-	-	-	-	-	-	6.12	5.52	-	6.12	5.52	-
Critical Hdwy Stg 2	-	-	-	-	-	-	6.12	5.52	-	6.12	5.52	-
Follow-up Hdwy	2.218	-	-	2.218	-	-	3.518	4.018	3.318	3.518	4.018	3.318
Pot Cap-1 Maneuver	1189	-	-	1222	-	-	211	238	714	216	245	704
Stage 1	-	-	-	-	-	-	598	579	-	521	517	-
Stage 2	-	-	-	-	-	-	491	500	-	575	573	-
Platoon blocked, %	-	-	-	-	-	-	-	-	-	-	-	-
Mov Cap-1 Maneuver	1189	-	-	1222	-	-	151	202	714	161	208	704
Mov Cap-2 Maneuver	-	-	-	-	-	-	151	202	-	161	208	-
Stage 1	-	-	-	-	-	-	570	552	-	497	461	-
Stage 2	-	-	-	-	-	-	373	446	-	494	547	-

Approach	EB			WB			NB			SB		
HCM Control Delay, s	1.1			1.8			31			173		
HCM LOS							D			F		

Minor Lane/Major Mvmt	NBLn1	EBL	EBT	EBR	WBL	WBT	WBR	SBLn1
Capacity (veh/h)	231	1189	-	-	1222	-	-	206
HCM Lane V/C Ratio	0.41	0.046	-	-	0.086	-	-	1.196
HCM Control Delay (s)	31	8.2	-	-	8.2	0	-	173
HCM Lane LOS	D	A	-	-	A	A	-	F
HCM 95th %tile Q(veh)	1.9	0.1	-	-	0.3	-	-	12.5

HCM 6th Signalized Intersection Summary  
 17: Main St/Petaluma Hill Rd & Old Adobe Rd/Adobe Rd

Cumulative plus Project Conditions AM



Movement	EBL	EBT	EBR	WBL	WBT	WBR	NBL	NBT	NBR	SBL	SBT	SBR
Lane Configurations		↕			↕			↕		↕	↕	↕
Traffic Volume (veh/h)	64	264	100	20	132	410	60	283	20	510	664	71
Future Volume (veh/h)	64	264	100	20	132	410	60	283	20	510	664	71
Initial Q (Qb), veh	0	0	0	0	0	0	0	0	0	0	0	0
Ped-Bike Adj(A_pbT)	1.00		0.99	1.00		0.99	1.00		1.00	1.00		0.99
Parking Bus, Adj	1.00	1.00	1.00	1.00	1.00	1.00	1.00	1.00	1.00	1.00	1.00	1.00
Work Zone On Approach		No			No			No			No	
Adj Sat Flow, veh/h/ln	1870	1870	1870	1870	1870	1870	1870	1870	1870	1870	1870	1870
Adj Flow Rate, veh/h	67	278	89	21	139	287	63	298	18	537	699	70
Peak Hour Factor	0.95	0.95	0.95	0.95	0.95	0.95	0.95	0.95	0.95	0.95	0.95	0.95
Percent Heavy Veh, %	2	2	2	2	2	2	2	2	2	2	2	2
Cap, veh/h	116	336	100	71	175	336	74	348	21	380	356	36
Arrive On Green	0.31	0.31	0.31	0.31	0.31	0.31	0.24	0.24	0.24	0.21	0.21	0.21
Sat Flow, veh/h	167	1096	326	39	572	1095	306	1446	87	1781	1671	167
Grp Volume(v), veh/h	434	0	0	447	0	0	379	0	0	537	0	769
Grp Sat Flow(s),veh/h/ln	1590	0	0	1706	0	0	1839	0	0	1781	0	1838
Q Serve(g_s), s	1.0	0.0	0.0	0.0	0.0	0.0	12.7	0.0	0.0	13.7	0.0	13.7
Cycle Q Clear(g_c), s	16.7	0.0	0.0	15.7	0.0	0.0	12.7	0.0	0.0	13.7	0.0	13.7
Prop In Lane	0.15		0.21	0.05		0.64	0.17		0.05	1.00		0.09
Lane Grp Cap(c), veh/h	552	0	0	581	0	0	442	0	0	380	0	392
V/C Ratio(X)	0.79	0.00	0.00	0.77	0.00	0.00	0.86	0.00	0.00	1.41	0.00	1.96
Avail Cap(c_a), veh/h	658	0	0	808	0	0	544	0	0	380	0	392
HCM Platoon Ratio	1.00	1.00	1.00	1.00	1.00	1.00	1.00	1.00	1.00	1.00	1.00	1.00
Upstream Filter(I)	1.00	0.00	0.00	1.00	0.00	0.00	1.00	0.00	0.00	1.00	0.00	1.00
Uniform Delay (d), s/veh	20.9	0.0	0.0	21.0	0.0	0.0	23.3	0.0	0.0	25.3	0.0	25.3
Incr Delay (d2), s/veh	4.3	0.0	0.0	1.8	0.0	0.0	10.3	0.0	0.0	201.0	0.0	441.8
Initial Q Delay(d3),s/veh	0.0	0.0	0.0	0.0	0.0	0.0	0.0	0.0	0.0	0.0	0.0	0.0
%ile BackOfQ(50%),veh/ln	6.1	0.0	0.0	5.8	0.0	0.0	6.5	0.0	0.0	26.5	0.0	53.6
Unsig. Movement Delay, s/veh												
LnGrp Delay(d),s/veh	25.2	0.0	0.0	22.8	0.0	0.0	33.6	0.0	0.0	226.2	0.0	467.1
LnGrp LOS	C	A	A	C	A	A	C	A	A	F	A	F
Approach Vol, veh/h		434			447			379				1306
Approach Delay, s/veh		25.2			22.8			33.6				368.1
Approach LOS		C			C			C				F
Timer - Assigned Phs		2		4		6		8				
Phs Duration (G+Y+Rc), s		20.0		25.1		19.1		25.1				
Change Period (Y+Rc), s		4.6		* 5.4		5.4		5.4				
Max Green Setting (Gmax), s		19.0		* 24		13.7		28.7				
Max Q Clear Time (g_c+I1), s		14.7		18.7		15.7		17.7				
Green Ext Time (p_c), s		0.8		0.6		0.0		0.8				

Intersection Summary

HCM 6th Ctrl Delay	200.5
HCM 6th LOS	F

Notes

- User approved pedestrian interval to be less than phase max green.
- \* HCM 6th computational engine requires equal clearance times for the phases crossing the barrier.

# HCM 6th Signalized Intersection Summary

## 18: Old Redwood Hwy & Main St

Cumulative plus Project Conditions AM



Movement	WBL	WBR	NBT	NBR	SBL	SBT
Lane Configurations						
Traffic Volume (veh/h)	680	33	278	335	43	706
Future Volume (veh/h)	680	33	278	335	43	706
Initial Q (Qb), veh	0	0	0	0	0	0
Ped-Bike Adj(A_pbT)	1.00	1.00		1.00	1.00	
Parking Bus, Adj	1.00	1.00	1.00	1.00	1.00	1.00
Work Zone On Approach	No		No		No	
Adj Sat Flow, veh/h/ln	1870	1870	1870	1870	1870	1870
Adj Flow Rate, veh/h	716	13	293	353	45	743
Peak Hour Factor	0.95	0.95	0.95	0.95	0.95	0.95
Percent Heavy Veh, %	2	2	2	2	2	2
Cap, veh/h	750	667	550	466	60	784
Arrive On Green	0.42	0.42	0.29	0.29	0.03	0.42
Sat Flow, veh/h	1781	1585	1870	1585	1781	1870
Grp Volume(v), veh/h	716	13	293	353	45	743
Grp Sat Flow(s),veh/h/ln	1781	1585	1870	1585	1781	1870
Q Serve(g_s), s	26.3	0.3	8.9	13.7	1.7	25.9
Cycle Q Clear(g_c), s	26.3	0.3	8.9	13.7	1.7	25.9
Prop In Lane	1.00	1.00		1.00	1.00	
Lane Grp Cap(c), veh/h	750	667	550	466	60	784
V/C Ratio(X)	0.96	0.02	0.53	0.76	0.75	0.95
Avail Cap(c_a), veh/h	790	703	830	703	316	830
HCM Platoon Ratio	1.00	1.00	1.00	1.00	1.00	1.00
Upstream Filter(I)	1.00	1.00	1.00	1.00	1.00	1.00
Uniform Delay (d), s/veh	19.0	11.4	20.0	21.7	32.4	18.9
Incr Delay (d2), s/veh	20.8	0.0	0.3	1.0	6.7	18.6
Initial Q Delay(d3),s/veh	0.0	0.0	0.0	0.0	0.0	0.0
%ile BackOfQ(50%),veh/ln	14.2	0.1	3.5	4.6	0.8	13.4
Unsig. Movement Delay, s/veh						
LnGrp Delay(d),s/veh	39.8	11.4	20.3	22.7	39.1	37.5
LnGrp LOS	D	B	C	C	D	D
Approach Vol, veh/h	729		646			788
Approach Delay, s/veh	39.2		21.6			37.6
Approach LOS	D		C			D
Timer - Assigned Phs	1	2		4		6
Phs Duration (G+Y+Rc), s	8.5	26.1		33.1		34.6
Change Period (Y+Rc), s	6.2	6.2		4.6		6.2
Max Green Setting (Gmax), s	30.0	30.0		30.0		30.0
Max Q Clear Time (g_c+1), s	15.7	15.7		28.3		27.9
Green Ext Time (p_c), s	0.0	0.6		0.1		0.5

### Intersection Summary

HCM 6th Ctrl Delay	33.4
HCM 6th LOS	C

### Notes

User approved pedestrian interval to be less than phase max green.

HCM 6th TWSC  
 19: Private Dwy/Paula Ln & Bodega Ave

Cumulative plus Project Conditions AM

Intersection												
Int Delay, s/veh	3.9											
Movement	EBL	EBT	EBR	WBL	WBT	WBR	NBL	NBT	NBR	SBL	SBT	SBR
Lane Configurations	↖	↗		↖	↗			↕			↕	
Traffic Vol, veh/h	30	575	5	15	425	35	5	10	25	55	5	30
Future Vol, veh/h	30	575	5	15	425	35	5	10	25	55	5	30
Conflicting Peds, #/hr	0	0	0	0	0	0	0	0	0	0	0	0
Sign Control	Free	Free	Free	Free	Free	Free	Stop	Stop	Stop	Stop	Stop	Stop
RT Channelized	-	-	None	-	-	None	-	-	None	-	-	None
Storage Length	90	-	-	90	-	-	-	-	-	-	-	-
Veh in Median Storage, #	-	0	-	-	0	-	-	0	-	-	0	-
Grade, %	-	0	-	-	0	-	-	0	-	-	0	-
Peak Hour Factor	95	95	95	95	95	95	95	95	95	95	95	95
Heavy Vehicles, %	2	2	2	2	2	2	2	2	2	2	2	2
Mvmt Flow	32	605	5	16	447	37	5	11	26	58	5	32























Major/Minor	Major1			Major2			Minor1			Minor2		
Conflicting Flow All	484	0	0	610	0	0	1188	1188	608	1188	1172	466
Stage 1	-	-	-	-	-	-	672	672	-	498	498	-
Stage 2	-	-	-	-	-	-	516	516	-	690	674	-
Critical Hdwy	4.12	-	-	4.12	-	-	7.12	6.52	6.22	7.12	6.52	6.22
Critical Hdwy Stg 1	-	-	-	-	-	-	6.12	5.52	-	6.12	5.52	-
Critical Hdwy Stg 2	-	-	-	-	-	-	6.12	5.52	-	6.12	5.52	-
Follow-up Hdwy	2.218	-	-	2.218	-	-	3.518	4.018	3.318	3.518	4.018	3.318
Pot Cap-1 Maneuver	1079	-	-	969	-	-	165	188	496	165	192	597
Stage 1	-	-	-	-	-	-	445	454	-	554	544	-
Stage 2	-	-	-	-	-	-	542	534	-	435	454	-
Platoon blocked, %	-	-	-	-	-	-	-	-	-	-	-	-
Mov Cap-1 Maneuver	1079	-	-	969	-	-	148	179	496	144	183	597
Mov Cap-2 Maneuver	-	-	-	-	-	-	148	179	-	144	183	-
Stage 1	-	-	-	-	-	-	432	440	-	537	535	-
Stage 2	-	-	-	-	-	-	500	525	-	390	440	-

Approach	EB			WB			NB			SB		
HCM Control Delay, s	0.4			0.3			19.7			39.4		
HCM LOS							C			E		

Minor Lane/Major Mvmt	NBLn1	EBL	EBT	EBR	WBL	WBT	WBR	SBLn1
Capacity (veh/h)	286	1079	-	-	969	-	-	196
HCM Lane V/C Ratio	0.147	0.029	-	-	0.016	-	-	0.483
HCM Control Delay (s)	19.7	8.4	-	-	8.8	-	-	39.4
HCM Lane LOS	C	A	-	-	A	-	-	E
HCM 95th %tile Q(veh)	0.5	0.1	-	-	0.1	-	-	2.4

HCM 6th Signalized Intersection Summary  
 20: Broadway & Leveroni Rd/Napa Rd

Cumulative plus Project Conditions AM

												
Movement	EBL	EBT	EBR	WBL	WBT	WBR	NBL	NBT	NBR	SBL	SBT	SBR
Lane Configurations												
Traffic Volume (veh/h)	340	390	91	81	280	300	83	398	143	230	262	90
Future Volume (veh/h)	340	390	91	81	280	300	83	398	143	230	262	90
Initial Q (Qb), veh	0	0	0	0	0	0	0	0	0	0	0	0
Ped-Bike Adj(A_pbT)	1.00		1.00	1.00		0.99	1.00		0.99	1.00		0.99
Parking Bus, Adj	1.00	1.00	1.00	1.00	1.00	1.00	1.00	1.00	1.00	1.00	1.00	1.00
Work Zone On Approach		No			No			No			No	
Adj Sat Flow, veh/h/ln	1870	1870	1870	1870	1870	1870	1870	1870	1870	1870	1870	1870
Adj Flow Rate, veh/h	358	411	90	85	295	282	87	419	117	242	276	64
Peak Hour Factor	0.95	0.95	0.95	0.95	0.95	0.95	0.95	0.95	0.95	0.95	0.95	0.95
Percent Heavy Veh, %	2	2	2	2	2	2	2	2	2	2	2	2
Cap, veh/h	389	611	134	167	252	241	168	512	141	264	690	157
Arrive On Green	0.22	0.41	0.41	0.09	0.29	0.29	0.09	0.19	0.19	0.15	0.24	0.24
Sat Flow, veh/h	1781	1485	325	1781	876	838	1781	2741	758	1781	2868	653
Grp Volume(v), veh/h	358	0	501	85	0	577	87	270	266	242	169	171
Grp Sat Flow(s),veh/h/ln	1781	0	1810	1781	0	1714	1781	1777	1722	1781	1777	1745
Q Serve(g_s), s	21.2	0.0	24.3	4.9	0.0	31.0	5.0	15.7	16.0	14.4	8.6	8.9
Cycle Q Clear(g_c), s	21.2	0.0	24.3	4.9	0.0	31.0	5.0	15.7	16.0	14.4	8.6	8.9
Prop In Lane	1.00		0.18	1.00		0.49	1.00		0.44	1.00		0.37
Lane Grp Cap(c), veh/h	389	0	745	167	0	493	168	332	321	264	427	420
V/C Ratio(X)	0.92	0.00	0.67	0.51	0.00	1.17	0.52	0.81	0.83	0.92	0.40	0.41
Avail Cap(c_a), veh/h	429	0	745	429	0	493	182	445	431	264	445	437
HCM Platoon Ratio	1.00	1.00	1.00	1.00	1.00	1.00	1.00	1.00	1.00	1.00	1.00	1.00
Upstream Filter(I)	1.00	0.00	1.00	1.00	0.00	1.00	1.00	1.00	1.00	1.00	1.00	1.00
Uniform Delay (d), s/veh	41.3	0.0	25.8	46.5	0.0	38.4	46.5	42.1	42.2	45.3	34.4	34.5
Incr Delay (d2), s/veh	23.9	0.0	2.4	2.4	0.0	96.9	2.4	8.3	9.5	34.0	0.6	0.6
Initial Q Delay(d3),s/veh	0.0	0.0	0.0	0.0	0.0	0.0	0.0	0.0	0.0	0.0	0.0	0.0
%ile BackOfQ(50%),veh/ln	11.5	0.0	10.2	2.2	0.0	25.7	2.3	7.4	7.4	8.8	3.7	3.8
Unsig. Movement Delay, s/veh												
LnGrp Delay(d),s/veh	65.2	0.0	28.2	48.9	0.0	135.3	48.9	50.4	51.7	79.2	35.0	35.1
LnGrp LOS	E	A	C	D	A	F	D	D	D	E	C	D
Approach Vol, veh/h		859			662			623			582	
Approach Delay, s/veh		43.6			124.2			50.8			53.4	
Approach LOS		D			F			D			D	
Timer - Assigned Phs	1	2	3	4	5	6	7	8				
Phs Duration (G+Y+Rc), s	14.2	31.0	27.5	35.2	20.0	25.1	14.1	48.6				
Change Period (Y+Rc), s	4.0	5.0	4.0	* 4.2	4.0	5.0	4.0	* 4.2				
Max Green Setting (Gmax), s	11.0	27.0	26.0	* 31	16.0	27.0	26.0	* 31				
Max Q Clear Time (g_c+I1), s	7.0	10.9	23.2	33.0	16.4	18.0	6.9	26.3				
Green Ext Time (p_c), s	0.1	1.7	0.3	0.0	0.0	2.0	0.2	1.2				

Intersection Summary

HCM 6th Ctrl Delay	66.9
HCM 6th LOS	E

Notes

\* HCM 6th computational engine requires equal clearance times for the phases crossing the barrier.

HCM 6th AWSC  
1: Geyserville Ave & Canyon Road

08/02/2020

Intersection	
Intersection Delay, s/veh	9.8
Intersection LOS	A

Movement	EBL	EBT	EBR	WBL	WBT	WBR	NBL	NBT	NBR	SBL	SBT	SBR
Lane Configurations		↕			↕			↕			↕	
Traffic Vol, veh/h	50	20	148	20	20	20	186	50	20	20	50	30
Future Vol, veh/h	50	20	148	20	20	20	186	50	20	20	50	30
Peak Hour Factor	0.95	0.95	0.95	0.95	0.95	0.95	0.95	0.95	0.95	0.95	0.95	0.95
Heavy Vehicles, %	2	2	2	2	2	2	2	2	2	2	2	2
Mvmt Flow	53	21	156	21	21	21	196	53	21	21	53	32
Number of Lanes	0	1	0	0	1	0	0	1	0	0	1	0

Approach	EB	WB	NB	SB
Opposing Approach	WB	EB	SB	NB
Opposing Lanes	1	1	1	1
Conflicting Approach Left	SB	NB	EB	WB
Conflicting Lanes Left	1	1	1	1
Conflicting Approach Right	NB	SB	WB	EB
Conflicting Lanes Right	1	1	1	1
HCM Control Delay	9.5	8.6	10.7	8.7
HCM LOS	A	A	B	A

Lane	NBLn1	EBLn1	WBLn1	SBLn1
Vol Left, %	73%	23%	33%	20%
Vol Thru, %	20%	9%	33%	50%
Vol Right, %	8%	68%	33%	30%
Sign Control	Stop	Stop	Stop	Stop
Traffic Vol by Lane	256	218	60	100
LT Vol	186	50	20	20
Through Vol	50	20	20	50
RT Vol	20	148	20	30
Lane Flow Rate	269	229	63	105
Geometry Grp	1	1	1	1
Degree of Util (X)	0.363	0.291	0.088	0.141
Departure Headway (Hd)	4.843	4.563	5	4.818
Convergence, Y/N	Yes	Yes	Yes	Yes
Cap	738	783	711	738
Service Time	2.903	2.619	3.073	2.889
HCM Lane V/C Ratio	0.364	0.292	0.089	0.142
HCM Control Delay	10.7	9.5	8.6	8.7
HCM Lane LOS	B	A	A	A
HCM 95th-tile Q	1.7	1.2	0.3	0.5



# HCM 6th Signalized Intersection Summary

## 2: Armstrong Woods Rd & River Rd

08/02/2020



Movement	EBL	EBT	EBR	WBL	WBT	WBR	NBL	NBT	NBR	SBL	SBT	SBR
Lane Configurations												
Traffic Volume (veh/h)	94	540	0	0	650	324	20	56	30	157	0	102
Future Volume (veh/h)	94	540	0	0	650	324	20	56	30	157	0	102
Initial Q (Qb), veh	0	0	0	0	0	0	0	0	0	0	0	0
Ped-Bike Adj(A_pbT)	1.00		1.00	1.00		0.99	0.99		0.99	0.99		0.99
Parking Bus, Adj	1.00	1.00	1.00	1.00	1.00	1.00	1.00	1.00	1.00	1.00	1.00	1.00
Work Zone On Approach		No			No			No			No	
Adj Sat Flow, veh/h/ln	1870	1870	0	0	1870	1870	1870	1870	1870	1870	1870	1870
Adj Flow Rate, veh/h	99	568	0	0	684	224	21	59	15	165	0	19
Peak Hour Factor	0.95	0.95	0.95	0.95	0.95	0.95	0.95	0.95	0.95	0.95	0.95	0.95
Percent Heavy Veh, %	2	2	0	0	2	2	2	2	2	2	2	2
Cap, veh/h	388	1196	0	0	868	732	385	288	73	341	0	314
Arrive On Green	0.10	0.64	0.00	0.00	0.46	0.46	0.20	0.20	0.20	0.20	0.00	0.20
Sat Flow, veh/h	1781	1870	0	0	1870	1577	1377	1435	365	1312	0	1565
Grp Volume(v), veh/h	99	568	0	0	684	224	21	0	74	165	0	19
Grp Sat Flow(s),veh/h/ln	1781	1870	0	0	1870	1577	1377	0	1799	1312	0	1565
Q Serve(g_s), s	1.4	9.3	0.0	0.0	18.2	5.2	0.7	0.0	2.0	7.1	0.0	0.6
Cycle Q Clear(g_c), s	1.4	9.3	0.0	0.0	18.2	5.2	1.3	0.0	2.0	9.1	0.0	0.6
Prop In Lane	1.00		0.00	0.00		1.00	1.00		0.20	1.00		1.00
Lane Grp Cap(c), veh/h	388	1196	0	0	868	732	385	0	361	341	0	314
V/C Ratio(X)	0.26	0.47	0.00	0.00	0.79	0.31	0.05	0.00	0.20	0.48	0.00	0.06
Avail Cap(c_a), veh/h	430	1196	0	0	2288	1929	530	0	550	479	0	479
HCM Platoon Ratio	1.00	1.00	1.00	1.00	1.00	1.00	1.00	1.00	1.00	1.00	1.00	1.00
Upstream Filter(I)	1.00	1.00	0.00	0.00	1.00	1.00	1.00	0.00	1.00	1.00	0.00	1.00
Uniform Delay (d), s/veh	9.3	5.5	0.0	0.0	13.3	9.8	19.6	0.0	19.6	23.4	0.0	19.0
Incr Delay (d2), s/veh	0.3	0.3	0.0	0.0	1.6	0.2	0.1	0.0	0.3	1.1	0.0	0.1
Initial Q Delay(d3),s/veh	0.0	0.0	0.0	0.0	0.0	0.0	0.0	0.0	0.0	0.0	0.0	0.0
%ile BackOfQ(50%),veh/ln	0.4	2.7	0.0	0.0	7.0	1.6	0.2	0.0	0.8	2.2	0.0	0.2
Unsig. Movement Delay, s/veh												
LnGrp Delay(d),s/veh	9.6	5.8	0.0	0.0	14.9	10.1	19.6	0.0	19.9	24.5	0.0	19.1
LnGrp LOS	A	A	A	A	B	B	B	A	B	C	A	B
Approach Vol, veh/h		667			908			95				184
Approach Delay, s/veh		6.4			13.7			19.8				23.9
Approach LOS		A			B			B				C
Timer - Assigned Phs		2		4	5	6		8				
Phs Duration (G+Y+Rc), s		42.3		16.5	10.3	32.0		16.5				
Change Period (Y+Rc), s		* 4.7		* 4.7	* 4.7	* 4.7		* 4.7				
Max Green Setting (Gmax), s		* 32		* 18	* 7	* 72		* 18				
Max Q Clear Time (g_c+I1), s		11.3		11.1	3.4	20.2		4.0				
Green Ext Time (p_c), s		4.0		0.3	0.1	7.2		0.3				

### Intersection Summary

HCM 6th Ctrl Delay	12.4
HCM 6th LOS	B

### Notes

User approved pedestrian interval to be less than phase max green.  
 \* HCM 6th computational engine requires equal clearance times for the phases crossing the barrier.

# HCM 6th Signalized Intersection Summary

## 3: Gravenstein Hwy/Old River Rd & River Rd

08/02/2020



Movement	EBL	EBT	EBR	WBL	WBT	WBR	NBL	NBT	NBR	SBL	SBT	SBR
Lane Configurations		↑	↗	↖	↗	↖	↗	↖			↕	
Traffic Volume (veh/h)	0	520	207	90	665	30	259	20	50	30	30	50
Future Volume (veh/h)	0	520	207	90	665	30	259	20	50	30	30	50
Initial Q (Qb), veh	0	0	0	0	0	0	0	0	0	0	0	0
Ped-Bike Adj(A_pbT)	1.00		0.99	1.00		1.00	0.99		1.00	1.00		0.99
Parking Bus, Adj	1.00	1.00	1.00	1.00	1.00	1.00	1.00	1.00	1.00	1.00	1.00	1.00
Work Zone On Approach		No		No		No		No		No		No
Adj Sat Flow, veh/h/ln	0	1870	1870	1870	1870	1870	1870	1870	1870	1870	1870	1870
Adj Flow Rate, veh/h	0	547	157	95	700	30	273	21	14	32	32	14
Peak Hour Factor	0.95	0.95	0.95	0.95	0.95	0.95	0.95	0.95	0.95	0.95	0.95	0.95
Percent Heavy Veh, %	0	2	2	2	2	2	2	2	2	2	2	2
Cap, veh/h	0	671	564	441	1032	44	474	249	166	218	199	70
Arrive On Green	0.00	0.36	0.36	0.13	0.58	0.58	0.24	0.24	0.24	0.24	0.24	0.24
Sat Flow, veh/h	0	1870	1574	1781	1780	76	1348	1047	698	502	837	293
Grp Volume(v), veh/h	0	547	157	95	0	730	273	0	35	78	0	0
Grp Sat Flow(s),veh/h/ln	0	1870	1574	1781	0	1856	1348	0	1745	1632	0	0
Q Serve(g_s), s	0.0	13.6	3.7	1.4	0.0	14.0	7.5	0.0	0.8	0.0	0.0	0.0
Cycle Q Clear(g_c), s	0.0	13.6	3.7	1.4	0.0	14.0	9.3	0.0	0.8	1.8	0.0	0.0
Prop In Lane	0.00		1.00	1.00		0.04	1.00		0.40	0.41		0.18
Lane Grp Cap(c), veh/h	0	671	564	441	0	1076	474	0	414	486	0	0
V/C Ratio(X)	0.00	0.82	0.28	0.22	0.00	0.68	0.58	0.00	0.08	0.16	0.00	0.00
Avail Cap(c_a), veh/h	0	872	734	521	0	1076	940	0	1017	486	0	0
HCM Platoon Ratio	1.00	1.00	1.00	1.00	1.00	1.00	1.00	1.00	1.00	1.00	1.00	1.00
Upstream Filter(I)	0.00	1.00	1.00	1.00	0.00	1.00	1.00	0.00	1.00	1.00	0.00	0.00
Uniform Delay (d), s/veh	0.0	15.0	11.8	8.8	0.0	7.5	18.3	0.0	15.3	15.6	0.0	0.0
Incr Delay (d2), s/veh	0.0	4.7	0.3	0.2	0.0	1.7	1.1	0.0	0.1	0.2	0.0	0.0
Initial Q Delay(d3),s/veh	0.0	0.0	0.0	0.0	0.0	0.0	0.0	0.0	0.0	0.0	0.0	0.0
%ile BackOfQ(50%),veh/ln	0.0	5.9	1.2	0.4	0.0	4.6	2.9	0.0	0.3	0.7	0.0	0.0
Unsig. Movement Delay, s/veh												
LnGrp Delay(d),s/veh	0.0	19.6	12.0	9.0	0.0	9.2	19.4	0.0	15.4	15.8	0.0	0.0
LnGrp LOS	A	B	B	A	A	A	B	A	B	B	A	A
Approach Vol, veh/h		704			825			308				78
Approach Delay, s/veh		17.9			9.2			18.9				15.8
Approach LOS		B			A			B				B
Timer - Assigned Phs	1	2		4		6		8				
Phs Duration (G+Y+Rc), s	1.4	23.2		16.9		34.5		16.9				
Change Period (Y+Rc), s	4.7	* 4.7		* 4.7		* 4.7		* 4.7				
Max Green Setting (Gmax), s	24	* 24		* 10		* 24		* 30				
Max Q Clear Time (g_c+1), s	15.6			3.8		16.0		11.3				
Green Ext Time (p_c), s	0.1	2.8		0.1		3.3		1.0				

### Intersection Summary

HCM 6th Ctrl Delay	14.2
HCM 6th LOS	B

### Notes

- User approved pedestrian interval to be less than phase max green.
- \* HCM 6th computational engine requires equal clearance times for the phases crossing the barrier.

HCM 6th TWSC  
4: Old Redwood Hwy & Fulton Rd

08/02/2020

Intersection						
Int Delay, s/veh	285.7					
Movement	EBL	EBR	NBL	NBT	SBT	SBR
Lane Configurations	↖	↗	↖	↗	↗	↖
Traffic Vol, veh/h	412	80	60	804	645	325
Future Vol, veh/h	412	80	60	804	645	325
Conflicting Peds, #/hr	0	0	0	0	0	0
Sign Control	Stop	Stop	Free	Free	Free	Free
RT Channelized	-	Stop	-	None	-	None
Storage Length	0	90	70	-	-	100
Veh in Median Storage, #	0	-	-	0	0	-
Grade, %	0	-	-	0	0	-
Peak Hour Factor	95	95	95	95	95	95
Heavy Vehicles, %	2	2	2	2	2	2
Mvmt Flow	434	84	63	846	679	342

Major/Minor	Minor2	Major1	Major2			
Conflicting Flow All	1651	679	1021	0	-	0
Stage 1	679	-	-	-	-	-
Stage 2	972	-	-	-	-	-
Critical Hdwy	6.42	6.22	4.12	-	-	-
Critical Hdwy Stg 1	5.42	-	-	-	-	-
Critical Hdwy Stg 2	5.42	-	-	-	-	-
Follow-up Hdwy	3.518	3.318	2.218	-	-	-
Pot Cap-1 Maneuver	~ 109	452	680	-	-	-
Stage 1	504	-	-	-	-	-
Stage 2	~ 367	-	-	-	-	-
Platoon blocked, %				-	-	-
Mov Cap-1 Maneuver	~ 99	452	680	-	-	-
Mov Cap-2 Maneuver	~ 99	-	-	-	-	-
Stage 1	457	-	-	-	-	-
Stage 2	~ 367	-	-	-	-	-

Approach	EB	NB	SB
HCM Control Delay, \$	1349.3	0.8	0
HCM LOS	F		

Minor Lane/Major Mvmt	NBL	NBT	EBLn1	EBLn2	SBT	SBR
Capacity (veh/h)	680	-	99	452	-	-
HCM Lane V/C Ratio	0.093	-	4.381	0.186	-	-
HCM Control Delay (s)	10.8	\$	1608.4	14.8	-	-
HCM Lane LOS	B	-	F	B	-	-
HCM 95th %tile Q(veh)	0.3	-	45.4	0.7	-	-

Notes  
 -: Volume exceeds capacity    \$: Delay exceeds 300s    +: Computation Not Defined    \*: All major volume in platoon

HCM 6th Signalized Intersection Summary  
5: Fulton Rd & Airport Blvd

08/02/2020



Movement	EBL	EBT	EBR	WBL	WBT	WBR	NBL	NBT	NBR	SBL	SBT	SBR
Lane Configurations												
Traffic Volume (veh/h)	231	890	700	172	444	50	610	392	222	60	322	153
Future Volume (veh/h)	231	890	700	172	444	50	610	392	222	60	322	153
Initial Q (Qb), veh	0	0	0	0	0	0	0	0	0	0	0	0
Ped-Bike Adj(A_pbT)	1.00		0.99	1.00		0.99	1.00		0.99	1.00		0.99
Parking Bus, Adj	1.00	1.00	1.00	1.00	1.00	1.00	1.00	1.00	1.00	1.00	1.00	1.00
Work Zone On Approach		No			No			No			No	
Adj Sat Flow, veh/h/ln	1870	1870	1870	1870	1870	1870	1870	1870	1870	1870	1870	1870
Adj Flow Rate, veh/h	243	937	486	181	467	50	642	413	48	63	339	149
Peak Hour Factor	0.95	0.95	0.95	0.95	0.95	0.95	0.95	0.95	0.95	0.95	0.95	0.95
Percent Heavy Veh, %	2	2	2	2	2	2	2	2	2	2	2	2
Cap, veh/h	268	580	488	207	458	49	422	443	371	32	172	75
Arrive On Green	0.15	0.31	0.31	0.12	0.28	0.28	0.24	0.24	0.24	0.16	0.16	0.16
Sat Flow, veh/h	1781	1870	1572	1781	1659	178	1781	1870	1568	202	1088	478
Grp Volume(v), veh/h	243	937	486	181	0	517	642	413	48	551	0	0
Grp Sat Flow(s),veh/h/ln	1781	1870	1572	1781	0	1836	1781	1870	1568	1769	0	0
Q Serve(g_s), s	17.0	39.3	39.1	12.7	0.0	35.0	30.0	27.4	3.1	20.0	0.0	0.0
Cycle Q Clear(g_c), s	17.0	39.3	39.1	12.7	0.0	35.0	30.0	27.4	3.1	20.0	0.0	0.0
Prop In Lane	1.00		1.00	1.00		0.10	1.00		1.00	0.11		0.27
Lane Grp Cap(c), veh/h	268	580	488	207	0	507	422	443	371	279	0	0
V/C Ratio(X)	0.91	1.62	1.00	0.87	0.00	1.02	1.52	0.93	0.13	1.97	0.00	0.00
Avail Cap(c_a), veh/h	281	580	488	275	0	507	422	443	371	279	0	0
HCM Platoon Ratio	1.00	1.00	1.00	1.00	1.00	1.00	1.00	1.00	1.00	1.00	1.00	1.00
Upstream Filter(I)	1.00	1.00	1.00	1.00	0.00	1.00	1.00	1.00	1.00	1.00	0.00	0.00
Uniform Delay (d), s/veh	53.0	43.7	43.7	55.1	0.0	45.9	48.4	47.4	38.1	53.4	0.0	0.0
Incr Delay (d2), s/veh	29.2	284.9	39.9	17.0	0.0	45.0	247.1	26.4	0.1	451.1	0.0	0.0
Initial Q Delay(d3),s/veh	0.0	0.0	0.0	0.0	0.0	0.0	0.0	0.0	0.0	0.0	0.0	0.0
%ile BackOfQ(50%),veh/ln	9.6	63.3	20.0	6.6	0.0	21.8	41.8	15.6	1.2	43.8	0.0	0.0
Unsig. Movement Delay, s/veh												
LnGrp Delay(d),s/veh	82.2	328.7	83.5	72.1	0.0	90.8	295.4	73.8	38.1	504.5	0.0	0.0
LnGrp LOS	F	F	F	E	A	F	F	E	D	F	A	A
Approach Vol, veh/h		1666			698			1103			551	
Approach Delay, s/veh		221.2			86.0			201.3			504.5	
Approach LOS		F			F			F			F	
Timer - Assigned Phs	1	2		4	5	6		8				
Phs Duration (G+Y+Rc), s	20.5	45.3		25.1	24.8	41.0		35.8				
Change Period (Y+Rc), s	5.8	6.0		5.1	5.8	6.0		5.8				
Max Green Setting (Gmax), s	19.6	30.0		20.0	20.0	35.0		30.0				
Max Q Clear Time (g_c+I1), s	14.7	41.3		22.0	19.0	37.0		32.0				
Green Ext Time (p_c), s	0.1	0.0		0.0	0.0	0.0		0.0				

Intersection Summary

HCM 6th Ctrl Delay	231.1
HCM 6th LOS	F

Notes

User approved pedestrian interval to be less than phase max green.

# HCM 6th Signalized Intersection Summary

## 6: Old Redwood Hwy & Airport Blvd

08/02/2020



Movement	EBL	EBT	EBR	WBL	WBT	WBR	NBL	NBT	NBR	SBL	SBT	SBR
Lane Configurations												
Traffic Volume (veh/h)	100	231	571	30	131	50	345	754	30	70	564	70
Future Volume (veh/h)	100	231	571	30	131	50	345	754	30	70	564	70
Initial Q (Qb), veh	0	0	0	0	0	0	0	0	0	0	0	0
Ped-Bike Adj(A_pbT)	1.00		1.00	1.00		1.00	1.00		1.00	1.00		1.00
Parking Bus, Adj	1.00	1.00	1.00	1.00	1.00	1.00	1.00	1.00	1.00	1.00	1.00	1.00
Work Zone On Approach	No			No			No			No		
Adj Sat Flow, veh/h/ln	1870	1870	1870	1870	1870	1870	1870	1870	1870	1870	1870	1870
Adj Flow Rate, veh/h	105	243	227	32	138	38	363	794	14	74	594	21
Peak Hour Factor	0.95	0.95	0.95	0.95	0.95	0.95	0.95	0.95	0.95	0.95	0.95	0.95
Percent Heavy Veh, %	2	2	2	2	2	2	2	2	2	2	2	2
Cap, veh/h	133	337	285	44	170	47	397	945	801	95	628	533
Arrive On Green	0.07	0.18	0.18	0.02	0.12	0.12	0.22	0.51	0.51	0.05	0.34	0.34
Sat Flow, veh/h	1781	1870	1585	1781	1412	389	1781	1870	1585	1781	1870	1585
Grp Volume(v), veh/h	105	243	227	32	0	176	363	794	14	74	594	21
Grp Sat Flow(s),veh/h/ln	1781	1870	1585	1781	0	1800	1781	1870	1585	1781	1870	1585
Q Serve(g_s), s	4.9	10.5	11.7	1.5	0.0	8.1	17.0	31.2	0.4	3.5	26.4	0.8
Cycle Q Clear(g_c), s	4.9	10.5	11.7	1.5	0.0	8.1	17.0	31.2	0.4	3.5	26.4	0.8
Prop In Lane	1.00		1.00	1.00		0.22	1.00		1.00	1.00		1.00
Lane Grp Cap(c), veh/h	133	337	285	44	0	217	397	945	801	95	628	533
V/C Ratio(X)	0.79	0.72	0.80	0.72	0.00	0.81	0.92	0.84	0.02	0.78	0.95	0.04
Avail Cap(c_a), veh/h	250	876	742	250	0	548	417	945	801	209	657	557
HCM Platoon Ratio	1.00	1.00	1.00	1.00	1.00	1.00	1.00	1.00	1.00	1.00	1.00	1.00
Upstream Filter(I)	1.00	1.00	1.00	1.00	0.00	1.00	1.00	1.00	1.00	1.00	1.00	1.00
Uniform Delay (d), s/veh	38.8	33.0	33.5	41.3	0.0	36.6	32.4	18.2	10.5	39.9	27.6	19.1
Incr Delay (d2), s/veh	3.9	1.1	1.9	7.9	0.0	2.7	23.2	6.5	0.0	5.1	21.7	0.0
Initial Q Delay(d3),s/veh	0.0	0.0	0.0	0.0	0.0	0.0	0.0	0.0	0.0	0.0	0.0	0.0
%ile BackOfQ(50%),veh/ln	2.2	4.6	4.5	0.8	0.0	3.7	9.5	13.6	0.1	1.6	14.8	0.3
Unsig. Movement Delay, s/veh												
LnGrp Delay(d),s/veh	42.7	34.1	35.5	49.3	0.0	39.3	55.6	24.6	10.5	45.0	49.3	19.1
LnGrp LOS	D	C	D	D	A	D	E	C	B	D	D	B
Approach Vol, veh/h	575			208			1171			689		
Approach Delay, s/veh	36.2			40.9			34.1			47.9		
Approach LOS	D			D			C			D		
Timer - Assigned Phs	1	2	3	4	5	6	7	8				
Phs Duration (G+Y+Rc), s	6.7	20.8	24.1	33.8	11.8	15.7	9.7	48.3				
Change Period (Y+Rc), s	4.6	5.4	5.1	5.1	5.4	* 5.4	5.1	5.1				
Max Green Setting (Gmax), s	12.0	40.0	20.0	30.0	12.0	* 26	10.0	30.0				
Max Q Clear Time (g_c+1), s	13.5	13.7	19.0	28.4	6.9	10.1	5.5	33.2				
Green Ext Time (p_c), s	0.0	0.5	0.0	0.3	0.0	0.3	0.0	0.0				

### Intersection Summary

HCM 6th Ctrl Delay	38.7
HCM 6th LOS	D

### Notes

User approved pedestrian interval to be less than phase max green.  
 \* HCM 6th computational engine requires equal clearance times for the phases crossing the barrier.

HCM 6th TWSC  
7: Old Redwood Hwy & Creekside Apts/Faught Rd

08/02/2020

Intersection												
Int Delay, s/veh	771											
Movement	EBL	EBT	EBR	WBL	WBT	WBR	NBL	NBT	NBR	SBL	SBT	SBR
Lane Configurations		↕			↕		↑	↑	↑		↕	
Traffic Vol, veh/h	20	20	30	101	20	60	30	929	172	50	1005	50
Future Vol, veh/h	20	20	30	101	20	60	30	929	172	50	1005	50
Conflicting Peds, #/hr	0	0	0	0	0	0	0	0	0	0	0	0
Sign Control	Stop	Stop	Stop	Stop	Stop	Stop	Free	Free	Free	Free	Free	Free
RT Channelized	-	-	None	-	-	None	-	-	None	-	-	None
Storage Length	-	-	-	-	-	-	50	-	270	-	-	-
Veh in Median Storage, #	-	0	-	-	0	-	-	0	-	-	0	-
Grade, %	-	0	-	-	0	-	-	0	-	-	0	-
Peak Hour Factor	95	95	95	95	95	95	95	95	95	95	95	95
Heavy Vehicles, %	2	2	2	2	2	2	2	2	2	2	2	2
Mvmt Flow	21	21	32	106	21	63	32	978	181	53	1058	53

Major/Minor	Minor2		Minor1		Major1		Major2					
Conflicting Flow All	2366	2414	1085	2259	2259	978	1111	0	0	1159	0	0
Stage 1	1191	1191	-	1042	1042	-	-	-	-	-	-	-
Stage 2	1175	1223	-	1217	1217	-	-	-	-	-	-	-
Critical Hdwy	7.12	6.52	6.22	7.12	6.52	6.22	4.12	-	-	4.12	-	-
Critical Hdwy Stg 1	6.12	5.52	-	6.12	5.52	-	-	-	-	-	-	-
Critical Hdwy Stg 2	6.12	5.52	-	6.12	5.52	-	-	-	-	-	-	-
Follow-up Hdwy	3.518	4.018	3.318	3.518	4.018	3.318	2.218	-	-	2.218	-	-
Pot Cap-1 Maneuver	24	33	263	~ 29	41	304	629	-	-	603	-	-
Stage 1	229	261	-	277	307	-	-	-	-	-	-	-
Stage 2	233	252	-	221	253	-	-	-	-	-	-	-
Platoon blocked, %								-	-	-	-	-
Mov Cap-1 Maneuver	~ 7	24	263	~ 5	30	304	629	-	-	603	-	-
Mov Cap-2 Maneuver	~ 7	24	-	~ 5	30	-	-	-	-	-	-	-
Stage 1	217	200	-	263	291	-	-	-	-	-	-	-
Stage 2	163	239	-	133	194	-	-	-	-	-	-	-

Approach	EB		WB		NB		SB	
HCM Control Delay, \$	1824.6		9883.3		0.3		0.5	
HCM LOS	F		F					

Minor Lane/Major Mvmt	NBL	NBT	NBR	EBLn1	WBLn1	SBL	SBT	SBR
Capacity (veh/h)	629	-	-	18	9	603	-	-
HCM Lane V/C Ratio	0.05	-	-	4.094	21.17	0.087	-	-
HCM Control Delay (s)	11	-	-	\$ 1824.6	\$ 9883.3	11.5	0	-
HCM Lane LOS	B	-	-	F	F	B	A	-
HCM 95th %tile Q(veh)	0.2	-	-	9.8	25.5	0.3	-	-

Notes  
 -: Volume exceeds capacity    \$: Delay exceeds 300s    +: Computation Not Defined    \*: All major volume in platoon

HCM 6th Signalized Intersection Summary  
 8: Old Redwood Hwy & Mark West Commons Cir/Wikiup Dr

08/02/2020



Movement	EBL	EBT	EBR	WBL	WBT	WBR	NBL	NBT	NBR	SBL	SBT	SBR
Lane Configurations		↔			↔	↔	↔	↑	↔	↔	↑	↔
Traffic Volume (veh/h)	20	20	20	199	20	158	40	894	216	115	921	20
Future Volume (veh/h)	20	20	20	199	20	158	40	894	216	115	921	20
Initial Q (Qb), veh	0	0	0	0	0	0	0	0	0	0	0	0
Ped-Bike Adj(A_pbT)	1.00		0.99	1.00		0.99	1.00		0.99	1.00		0.99
Parking Bus, Adj	1.00	1.00	1.00	1.00	1.00	1.00	1.00	1.00	1.00	1.00	1.00	1.00
Work Zone On Approach		No			No			No			No	
Adj Sat Flow, veh/h/ln	1870	1870	1870	1870	1870	1870	1870	1870	1870	1870	1870	1870
Adj Flow Rate, veh/h	21	21	4	209	21	70	42	941	149	121	969	10
Peak Hour Factor	0.95	0.95	0.95	0.95	0.95	0.95	0.95	0.95	0.95	0.95	0.95	0.95
Percent Heavy Veh, %	2	2	2	2	2	2	2	2	2	2	2	2
Cap, veh/h	103	85	11	348	25	429	57	802	675	154	904	762
Arrive On Green	0.27	0.27	0.27	0.27	0.27	0.27	0.03	0.43	0.43	0.09	0.48	0.48
Sat Flow, veh/h	104	312	40	914	92	1571	1781	1870	1576	1781	1870	1577
Grp Volume(v), veh/h	46	0	0	230	0	70	42	941	149	121	969	10
Grp Sat Flow(s),veh/h/ln	455	0	0	1006	0	1571	1781	1870	1576	1781	1870	1577
Q Serve(g_s), s	0.4	0.0	0.0	0.0	0.0	2.4	1.6	30.0	4.2	4.7	33.8	0.2
Cycle Q Clear(g_c), s	16.7	0.0	0.0	16.3	0.0	2.4	1.6	30.0	4.2	4.7	33.8	0.2
Prop In Lane	0.46		0.09	0.91		1.00	1.00		1.00	1.00		1.00
Lane Grp Cap(c), veh/h	199	0	0	373	0	429	57	802	675	154	904	762
V/C Ratio(X)	0.23	0.00	0.00	0.62	0.00	0.16	0.74	1.17	0.22	0.78	1.07	0.01
Avail Cap(c_a), veh/h	199	0	0	491	0	561	305	802	675	305	904	762
HCM Platoon Ratio	1.00	1.00	1.00	1.00	1.00	1.00	1.00	1.00	1.00	1.00	1.00	1.00
Upstream Filter(I)	1.00	0.00	0.00	1.00	0.00	1.00	1.00	1.00	1.00	1.00	1.00	1.00
Uniform Delay (d), s/veh	20.4	0.0	0.0	24.4	0.0	19.3	33.6	20.0	12.6	31.3	18.1	9.4
Incr Delay (d2), s/veh	0.2	0.0	0.0	0.6	0.0	0.1	6.8	91.2	0.1	3.3	51.2	0.0
Initial Q Delay(d3),s/veh	0.0	0.0	0.0	0.0	0.0	0.0	0.0	0.0	0.0	0.0	0.0	0.0
%ile BackOfQ(50%),veh/ln	0.6	0.0	0.0	3.5	0.0	0.8	0.8	31.5	1.3	2.0	25.0	0.1
Unsig. Movement Delay, s/veh												
LnGrp Delay(d),s/veh	20.6	0.0	0.0	25.0	0.0	19.4	40.4	111.2	12.7	34.6	69.3	9.4
LnGrp LOS	C	A	A	C	A	B	D	F	B	C	F	A
Approach Vol, veh/h		46			300			1132			1100	
Approach Delay, s/veh		20.6			23.7			95.6			64.9	
Approach LOS		C			C			F			E	
Timer - Assigned Phs		2	3	4		6	7	8				
Phs Duration (G+Y+Rc), s		23.7	7.3	38.9		23.7	11.2	35.1				
Change Period (Y+Rc), s		4.6	5.1	5.1		4.6	5.1	5.1				
Max Green Setting (Gmax), s		12.0	12.0	30.0		25.0	12.0	30.0				
Max Q Clear Time (g_c+I1), s		18.7	3.6	35.8		18.3	6.7	32.0				
Green Ext Time (p_c), s		0.0	0.0	0.0		0.6	0.0	0.0				
<b>Intersection Summary</b>												
HCM 6th Ctrl Delay				72.8								
HCM 6th LOS				E								
<b>Notes</b>												
User approved pedestrian interval to be less than phase max green.												

HCM 6th TWSC  
 9: Pocket Canyon Hwy/Front St & Mirabel Rd

08/02/2020

Intersection						
Int Delay, s/veh	31.9					
Movement	EBL	EBT	WBT	WBR	SBL	SBR
Lane Configurations		↕	↑	↗	↖	↗
Traffic Vol, veh/h	52	285	299	653	413	80
Future Vol, veh/h	52	285	299	653	413	80
Conflicting Peds, #/hr	0	0	0	0	0	0
Sign Control	Free	Free	Free	Free	Stop	Stop
RT Channelized	-	None	-	Yield	-	None
Storage Length	-	-	-	150	90	0
Veh in Median Storage, #	-	0	0	-	0	-
Grade, %	-	0	0	-	0	-
Peak Hour Factor	95	95	95	95	95	95
Heavy Vehicles, %	2	2	2	2	2	2
Mvmt Flow	55	300	315	687	435	84

Major/Minor	Major1	Major2	Minor2		
Conflicting Flow All	315	0	-	0	725
Stage 1	-	-	-	-	315
Stage 2	-	-	-	-	410
Critical Hdwy	4.12	-	-	-	6.42
Critical Hdwy Stg 1	-	-	-	-	5.42
Critical Hdwy Stg 2	-	-	-	-	5.42
Follow-up Hdwy	2.218	-	-	-	3.518
Pot Cap-1 Maneuver	1245	-	-	-	~ 392
Stage 1	-	-	-	-	740
Stage 2	-	-	-	-	670
Platoon blocked, %		-	-	-	
Mov Cap-1 Maneuver	1245	-	-	-	~ 371
Mov Cap-2 Maneuver	-	-	-	-	~ 371
Stage 1	-	-	-	-	701
Stage 2	-	-	-	-	670

Approach	EB	WB	SB
HCM Control Delay, s	1.2	0	114.6
HCM LOS			F

Minor Lane/Major Mvmt	EBL	EBT	WBT	WBR	SBLn1	SBLn2
Capacity (veh/h)	1245	-	-	-	371	725
HCM Lane V/C Ratio	0.044	-	-	-	1.172	0.116
HCM Control Delay (s)	8	0	-	-	134.7	10.6
HCM Lane LOS	A	A	-	-	F	B
HCM 95th %tile Q(veh)	0.1	-	-	-	17.4	0.4

Notes  
 -: Volume exceeds capacity    \$: Delay exceeds 300s    +: Computation Not Defined    \*: All major volume in platoon



HCM 6th Signalized Intersection Summary  
 10: Gravenstein Hwy & Graton Rd/Frei Rd

08/02/2020



Movement	EBL	EBT	EBR	WBL	WBT	WBR	NBL	NBT	NBR	SBL	SBT	SBR
Lane Configurations		↖	↗		↔		↖	↗		↖	↗	
Traffic Volume (veh/h)	40	41	138	240	71	21	196	668	110	20	573	50
Future Volume (veh/h)	40	41	138	240	71	21	196	668	110	20	573	50
Initial Q (Qb), veh	0	0	0	0	0	0	0	0	0	0	0	0
Ped-Bike Adj(A_pbT)	1.00		0.99	0.99		0.99	1.00		1.00	1.00		0.99
Parking Bus, Adj	1.00	1.00	1.00	1.00	1.00	1.00	1.00	1.00	1.00	1.00	1.00	1.00
Work Zone On Approach		No			No			No			No	
Adj Sat Flow, veh/h/ln	1870	1870	1870	1870	1870	1870	1870	1870	1870	1870	1870	1870
Adj Flow Rate, veh/h	42	43	24	253	75	20	206	703	114	21	603	51
Peak Hour Factor	0.95	0.95	0.95	0.95	0.95	0.95	0.95	0.95	0.95	0.95	0.95	0.95
Percent Heavy Veh, %	2	2	2	2	2	2	2	2	2	2	2	2
Cap, veh/h	224	206	345	273	56	15	289	791	128	102	678	57
Arrive On Green	0.22	0.22	0.22	0.22	0.22	0.22	0.16	0.50	0.50	0.06	0.40	0.40
Sat Flow, veh/h	683	937	1567	853	253	67	1781	1569	254	1781	1700	144
Grp Volume(v), veh/h	85	0	24	348	0	0	206	0	817	21	0	654
Grp Sat Flow(s),veh/h/ln	1620	0	1567	1173	0	0	1781	0	1823	1781	0	1843
Q Serve(g_s), s	0.0	0.0	0.9	13.2	0.0	0.0	8.0	0.0	29.3	0.8	0.0	24.0
Cycle Q Clear(g_c), s	2.8	0.0	0.9	16.0	0.0	0.0	8.0	0.0	29.3	0.8	0.0	24.0
Prop In Lane	0.49		1.00	0.73		0.06	1.00		0.14	1.00		0.08
Lane Grp Cap(c), veh/h	431	0	345	344	0	0	289	0	919	102	0	735
V/C Ratio(X)	0.20	0.00	0.07	1.01	0.00	0.00	0.71	0.00	0.89	0.21	0.00	0.89
Avail Cap(c_a), veh/h	1150	0	1078	344	0	0	392	0	1254	1225	0	735
HCM Platoon Ratio	1.00	1.00	1.00	1.00	1.00	1.00	1.00	1.00	1.00	1.00	1.00	1.00
Upstream Filter(I)	1.00	0.00	1.00	1.00	0.00	0.00	1.00	0.00	1.00	1.00	0.00	1.00
Uniform Delay (d), s/veh	23.2	0.0	22.5	31.4	0.0	0.0	28.8	0.0	16.2	32.7	0.0	20.4
Incr Delay (d2), s/veh	0.2	0.0	0.1	51.8	0.0	0.0	3.8	0.0	6.3	1.0	0.0	13.0
Initial Q Delay(d3),s/veh	0.0	0.0	0.0	0.0	0.0	0.0	0.0	0.0	0.0	0.0	0.0	0.0
%ile BackOfQ(50%),veh/ln	1.2	0.0	0.3	10.7	0.0	0.0	3.4	0.0	11.2	0.4	0.0	11.4
Unsig. Movement Delay, s/veh												
LnGrp Delay(d),s/veh	23.4	0.0	22.5	83.2	0.0	0.0	32.6	0.0	22.5	33.7	0.0	33.3
LnGrp LOS	C	A	C	F	A	A	C	A	C	C	A	C
Approach Vol, veh/h		109			348			1023			675	
Approach Delay, s/veh		23.2			83.2			24.5			33.3	
Approach LOS		C			F			C			C	
Timer - Assigned Phs	1	2		4	5	6		8				
Phs Duration (G+Y+Rc), s	16.5	34.8		21.4	8.8	42.5		21.4				
Change Period (Y+Rc), s	* 4.7	5.8		5.4	* 4.7	5.8		5.4				
Max Green Setting (Gmax), s	* 16	25.0		16.0	* 50	50.0		50.0				
Max Q Clear Time (g_c+I1), s	10.0	26.0		18.0	2.8	31.3		4.8				
Green Ext Time (p_c), s	0.3	0.0		0.0	0.0	5.4		0.6				

Intersection Summary

HCM 6th Ctrl Delay	36.7
HCM 6th LOS	D

Notes

- User approved pedestrian interval to be less than phase max green.
- \* HCM 6th computational engine requires equal clearance times for the phases crossing the barrier.

HCM 6th TWSC  
11: Private Dwy/Moorland Ave & Todd Rd

08/02/2020

Intersection

Int Delay, s/veh 3701.3

Movement	EBL	EBT	EBR	WBL	WBT	WBR	NBL	NBT	NBR	SBL	SBT	SBR
Lane Configurations	↖	↗		↖	↗			↕			↖	↗
Traffic Vol, veh/h	72	748	20	30	625	490	20	30	30	505	30	42
Future Vol, veh/h	72	748	20	30	625	490	20	30	30	505	30	42
Conflicting Peds, #/hr	0	0	0	0	0	0	0	0	0	0	0	0
Sign Control	Free	Free	Free	Free	Free	Free	Stop	Stop	Stop	Stop	Stop	Stop
RT Channelized	-	-	None	-	-	None	-	-	None	-	-	None
Storage Length	100	-	-	70	-	-	-	-	-	-	-	60
Veh in Median Storage, #	-	0	-	-	0	-	-	0	-	-	0	-
Grade, %	-	0	-	-	0	-	-	0	-	-	0	-
Peak Hour Factor	95	95	95	95	95	95	95	95	95	95	95	95
Heavy Vehicles, %	2	2	2	2	2	2	2	2	2	2	2	2
Mvmt Flow	76	787	21	32	658	516	21	32	32	532	32	44

Major/Minor	Major1		Major2		Minor1		Minor2					
Conflicting Flow All	1174	0	0	808	0	0	1968	2188	798	1962	1940	916
Stage 1	-	-	-	-	-	-	950	950	-	980	980	-
Stage 2	-	-	-	-	-	-	1018	1238	-	982	960	-
Critical Hdwy	4.12	-	-	4.12	-	-	7.12	6.52	6.22	7.12	6.52	6.22
Critical Hdwy Stg 1	-	-	-	-	-	-	6.12	5.52	-	6.12	5.52	-
Critical Hdwy Stg 2	-	-	-	-	-	-	6.12	5.52	-	6.12	5.52	-
Follow-up Hdwy	2.218	-	-	2.218	-	-	3.518	4.018	3.318	3.518	4.018	3.318
Pot Cap-1 Maneuver	595	-	-	817	-	-	47	46	386	~ 47	65	330
Stage 1	-	-	-	-	-	-	312	339	-	~ 301	328	-
Stage 2	-	-	-	-	-	-	286	248	-	~ 300	335	-
Platoon blocked, %		-	-		-	-						
Mov Cap-1 Maneuver	595	-	-	817	-	-	~ 19	39	386	~ 13	54	330
Mov Cap-2 Maneuver	-	-	-	-	-	-	~ 19	39	-	~ 13	54	-
Stage 1	-	-	-	-	-	-	272	296	-	~ 262	315	-
Stage 2	-	-	-	-	-	-	214	238	-	~ 215	292	-

Approach	EB	WB	NB	SB
HCM Control Delay, s	1	0.3	\$ 675.3	\$ 16851.9
HCM LOS			F	F

Minor Lane/Major Mvmt	NBLn1	EBL	EBT	EBR	WBL	WBT	WBR	SBLn1	SBLn2
Capacity (veh/h)	42	595	-	-	817	-	-	14	330
HCM Lane V/C Ratio	2.005	0.127	-	-	0.039	-	-	40.226	0.134
HCM Control Delay (s)	\$ 675.3	11.9	-	-	9.6	-	-	\$ 18173.5	17.6
HCM Lane LOS	F	B	-	-	A	-	-	F	C
HCM 95th %tile Q(veh)	8.8	0.4	-	-	0.1	-	-	71.6	0.5

Notes  
 -: Volume exceeds capacity    \$: Delay exceeds 300s    +: Computation Not Defined    \*: All major volume in platoon

# HCM 6th Signalized Intersection Summary

## 12: S Moreland Ave & Todd Rd

08/02/2020



Movement	EBL	EBT	EBR	WBL	WBT	WBR	NBL	NBT	NBR	SBL	SBT	SBR
Lane Configurations		↖	↗	↖	↗		↖	↗	↗		↕	
Traffic Volume (veh/h)	0	585	698	460	413	0	732	0	197	0	0	0
Future Volume (veh/h)	0	585	698	460	413	0	732	0	197	0	0	0
Initial Q (Qb), veh	0	0	0	0	0	0	0	0	0	0	0	0
Ped-Bike Adj(A_pbT)	1.00		1.00	1.00		1.00	1.00		1.00	1.00		1.00
Parking Bus, Adj	1.00	1.00	1.00	1.00	1.00	1.00	1.00	1.00	1.00	1.00	1.00	1.00
Work Zone On Approach		No			No			No			No	
Adj Sat Flow, veh/h/ln	1870	1870	1870	1870	1870	1870	1870	1870	1870	1870	1870	1870
Adj Flow Rate, veh/h	0	616	462	484	435	0	771	0	132	0	0	0
Peak Hour Factor	0.95	0.95	0.95	0.95	0.95	0.95	0.95	0.95	0.95	0.95	0.95	0.95
Percent Heavy Veh, %	2	2	2	2	2	2	2	2	2	2	2	2
Cap, veh/h	0	473	401	561	589	0	563	0	1002	0	2	0
Arrive On Green	0.00	0.25	0.25	0.32	0.32	0.00	0.32	0.00	0.32	0.00	0.00	0.00
Sat Flow, veh/h	0	1870	1585	1781	1870	0	1781	0	3170	0	1870	0
Grp Volume(v), veh/h	0	616	462	484	435	0	771	0	132	0	0	0
Grp Sat Flow(s),veh/h/ln	0	1870	1585	1781	1870	0	1781	0	1585	0	1870	0
Q Serve(g_s), s	0.0	20.0	20.0	20.2	16.4	0.0	25.0	0.0	2.4	0.0	0.0	0.0
Cycle Q Clear(g_c), s	0.0	20.0	20.0	20.2	16.4	0.0	25.0	0.0	2.4	0.0	0.0	0.0
Prop In Lane	0.00		1.00	1.00		0.00	1.00		1.00	0.00		0.00
Lane Grp Cap(c), veh/h	0	473	401	561	589	0	563	0	1002	0	2	0
V/C Ratio(X)	0.00	1.30	1.15	0.86	0.74	0.00	1.37	0.00	0.13	0.00	0.00	0.00
Avail Cap(c_a), veh/h	0	473	401	675	709	0	563	0	1002	0	189	0
HCM Platoon Ratio	1.00	1.00	1.00	1.00	1.00	1.00	1.00	1.00	1.00	1.00	1.00	1.00
Upstream Filter(I)	0.00	1.00	1.00	1.00	1.00	0.00	1.00	0.00	1.00	0.00	0.00	0.00
Uniform Delay (d), s/veh	0.0	29.6	29.6	25.5	24.2	0.0	27.1	0.0	19.3	0.0	0.0	0.0
Incr Delay (d2), s/veh	0.0	151.1	93.8	9.7	3.3	0.0	177.6	0.0	0.1	0.0	0.0	0.0
Initial Q Delay(d3),s/veh	0.0	0.0	0.0	0.0	0.0	0.0	0.0	0.0	0.0	0.0	0.0	0.0
%ile BackOfQ(50%),veh/ln	0.0	28.3	17.6	9.4	7.3	0.0	37.8	0.0	0.8	0.0	0.0	0.0
Unsig. Movement Delay, s/veh												
LnGrp Delay(d),s/veh	0.0	180.7	123.4	35.2	27.5	0.0	204.7	0.0	19.4	0.0	0.0	0.0
LnGrp LOS	A	F	F	D	C	A	F	A	B	A	A	A
Approach Vol, veh/h		1078			919			903				0
Approach Delay, s/veh		156.1			31.5			177.6				0.0
Approach LOS		F			C			F				
Timer - Assigned Phs		2		4		6		8				
Phs Duration (G+Y+Rc), s		0.0		23.2		28.0		27.9				
Change Period (Y+Rc), s		3.0		3.2		3.0		3.0				
Max Green Setting (Gmax), s		8.0		20.0		25.0		30.0				
Max Q Clear Time (g_c+I1), s		0.0		22.0		27.0		22.2				
Green Ext Time (p_c), s		0.0		0.0		0.0		2.7				

### Intersection Summary

HCM 6th Ctrl Delay 123.3  
 HCM 6th LOS F

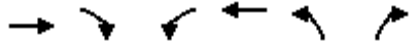
### Notes

User approved pedestrian interval to be less than phase max green.  
 User approved volume balancing among the lanes for turning movement.

# HCM 6th Signalized Intersection Summary

## 13: Todd Rd Overpass & Todd Rd

08/02/2020



Movement	EBT	EBR	WBL	WBT	NBL	NBR
Lane Configurations	↑↑	↗	↖	↑↑	↖	↗↗
Traffic Volume (veh/h)	265	345	474	428	315	803
Future Volume (veh/h)	265	345	474	428	315	803
Initial Q (Qb), veh	0	0	0	0	0	0
Ped-Bike Adj(A_pbT)		1.00	1.00		1.00	1.00
Parking Bus, Adj	1.00	1.00	1.00	1.00	1.00	1.00
Work Zone On Approach	No			No	No	
Adj Sat Flow, veh/h/ln	1870	1870	1870	1870	1870	1870
Adj Flow Rate, veh/h	279	67	530	408	332	542
Peak Hour Factor	0.95	0.95	0.95	0.95	0.95	0.95
Percent Heavy Veh, %	2	2	2	2	2	2
Cap, veh/h	578	258	1080	567	473	1586
Arrive On Green	0.16	0.16	0.30	0.30	0.27	0.27
Sat Flow, veh/h	3647	1585	3563	1870	1781	2790
Grp Volume(v), veh/h	279	67	530	408	332	542
Grp Sat Flow(s),veh/h/ln	1777	1585	1781	1870	1781	1395
Q Serve(g_s), s	2.8	1.4	4.8	7.6	6.6	4.1
Cycle Q Clear(g_c), s	2.8	1.4	4.8	7.6	6.6	4.1
Prop In Lane		1.00	1.00		1.00	1.00
Lane Grp Cap(c), veh/h	578	258	1080	567	473	1586
V/C Ratio(X)	0.48	0.26	0.49	0.72	0.70	0.34
Avail Cap(c_a), veh/h	1820	812	1369	719	639	1846
HCM Platoon Ratio	1.00	1.00	1.00	1.00	1.00	1.00
Upstream Filter(I)	1.00	1.00	1.00	1.00	1.00	1.00
Uniform Delay (d), s/veh	14.9	14.3	11.1	12.1	13.0	4.5
Incr Delay (d2), s/veh	0.6	0.5	0.3	2.6	2.2	0.1
Initial Q Delay(d3),s/veh	0.0	0.0	0.0	0.0	0.0	0.0
%ile BackOfQ(50%),veh/ln	1.0	0.5	1.5	2.9	2.4	1.7
Unsig. Movement Delay, s/veh						
LnGrp Delay(d),s/veh	15.5	14.8	11.5	14.7	15.1	4.6
LnGrp LOS	B	B	B	B	B	A
Approach Vol, veh/h	346			938	874	
Approach Delay, s/veh	15.4			12.9	8.6	
Approach LOS	B			B	A	
Timer - Assigned Phs		2			6	8
Phs Duration (G+Y+Rc), s		9.8			15.3	13.9
Change Period (Y+Rc), s		3.5			3.5	3.5
Max Green Setting (Gmax), s		20.0			15.0	14.0
Max Q Clear Time (g_c+I1), s		4.8			9.6	8.6
Green Ext Time (p_c), s		1.7			2.2	1.8

### Intersection Summary

HCM 6th Ctrl Delay	11.6
HCM 6th LOS	B

### Notes

User approved volume balancing among the lanes for turning movement.

# HCM 6th Signalized Intersection Summary

## 14: Santa Rosa Ave & Todd Rd

08/02/2020



Movement	EBL	EBT	EBR	WBL	WBT	WBR	NBL	NBT	NBR	SBL	SBT	SBR
Lane Configurations												
Traffic Volume (veh/h)	583	70	415	60	120	70	407	685	50	40	593	375
Future Volume (veh/h)	583	70	415	60	120	70	407	685	50	40	593	375
Initial Q (Qb), veh	0	0	0	0	0	0	0	0	0	0	0	0
Ped-Bike Adj(A_pbT)	1.00		0.99	1.00		1.00	1.00		0.99	1.00		0.99
Parking Bus, Adj	1.00	1.00	1.00	1.00	1.00	1.00	1.00	1.00	1.00	1.00	1.00	1.00
Work Zone On Approach		No			No			No			No	
Adj Sat Flow, veh/h/ln	1870	1870	1870	1870	1870	1870	1870	1870	1870	1870	1870	1870
Adj Flow Rate, veh/h	667	0	83	63	126	47	428	721	18	42	624	75
Peak Hour Factor	0.95	0.95	0.95	0.95	0.95	0.95	0.95	0.95	0.95	0.95	0.95	0.95
Percent Heavy Veh, %	2	2	2	2	2	2	2	2	2	2	2	2
Cap, veh/h	751	0	332	213	155	58	379	1337	593	54	702	311
Arrive On Green	0.21	0.00	0.21	0.12	0.12	0.12	0.21	0.38	0.38	0.03	0.20	0.20
Sat Flow, veh/h	3563	0	1574	1781	1299	484	1781	3554	1575	1781	3554	1573
Grp Volume(v), veh/h	667	0	83	63	0	173	428	721	18	42	624	75
Grp Sat Flow(s),veh/h/ln	1781	0	1574	1781	0	1783	1781	1777	1575	1781	1777	1573
Q Serve(g_s), s	14.5	0.0	3.5	2.6	0.0	7.6	17.0	12.7	0.6	1.9	13.6	3.2
Cycle Q Clear(g_c), s	14.5	0.0	3.5	2.6	0.0	7.6	17.0	12.7	0.6	1.9	13.6	3.2
Prop In Lane	1.00		1.00	1.00		0.27	1.00		1.00	1.00		1.00
Lane Grp Cap(c), veh/h	751	0	332	213	0	213	379	1337	593	54	702	311
V/C Ratio(X)	0.89	0.00	0.25	0.30	0.00	0.81	1.13	0.54	0.03	0.78	0.89	0.24
Avail Cap(c_a), veh/h	803	0	355	223	0	223	379	1337	593	223	712	315
HCM Platoon Ratio	1.00	1.00	1.00	1.00	1.00	1.00	1.00	1.00	1.00	1.00	1.00	1.00
Upstream Filter(I)	1.00	0.00	1.00	1.00	0.00	1.00	1.00	1.00	1.00	1.00	1.00	1.00
Uniform Delay (d), s/veh	30.6	0.0	26.2	32.1	0.0	34.3	31.4	19.5	15.7	38.4	31.2	27.0
Incr Delay (d2), s/veh	10.7	0.0	0.1	0.3	0.0	17.7	86.0	0.2	0.0	8.5	12.6	0.1
Initial Q Delay(d3),s/veh	0.0	0.0	0.0	0.0	0.0	0.0	0.0	0.0	0.0	0.0	0.0	0.0
%ile BackOfQ(50%),veh/ln	7.1	0.0	1.3	1.1	0.0	4.3	16.0	4.9	0.2	0.9	6.7	1.2
Unsig. Movement Delay, s/veh												
LnGrp Delay(d),s/veh	41.3	0.0	26.4	32.4	0.0	52.0	117.4	19.7	15.7	47.0	43.8	27.1
LnGrp LOS	D	A	C	C	A	D	F	B	B	D	D	C
Approach Vol, veh/h		750			236			1167			741	
Approach Delay, s/veh		39.7			46.8			55.5			42.3	
Approach LOS		D			D			E			D	
Timer - Assigned Phs		2	3	4		6	7	8				
Phs Duration (G+Y+Rc), s		21.9	22.1	21.2		14.6	7.8	35.5				
Change Period (Y+Rc), s		5.1	5.1	5.4		5.1	5.4	* 5.4				
Max Green Setting (Gmax), s		18.0	17.0	16.0		10.0	10.0	* 24				
Max Q Clear Time (g_c+I1), s		16.5	19.0	15.6		9.6	3.9	14.7				
Green Ext Time (p_c), s		0.3	0.0	0.1		0.0	0.0	1.9				

### Intersection Summary

HCM 6th Ctrl Delay	47.3
HCM 6th LOS	D

### Notes

- User approved pedestrian interval to be less than phase max green.
- User approved volume balancing among the lanes for turning movement.
- \* HCM 6th computational engine requires equal clearance times for the phases crossing the barrier.

HCM 6th AWSC  
 15: Arnold Dr & Warm Springs Rd/Private Dwy

08/02/2020

Intersection

Intersection Delay, s/veh 13.6

Intersection LOS B

Movement	EBL	EBT	EBR	WBL	WBT	WBR	NBL	NBT	NBR	SBL	SBT	SBR
Lane Configurations		↕			↕			↕			↕	
Traffic Vol, veh/h	60	20	222	20	20	20	162	182	20	20	142	70
Future Vol, veh/h	60	20	222	20	20	20	162	182	20	20	142	70
Peak Hour Factor	0.95	0.95	0.95	0.95	0.95	0.95	0.95	0.95	0.95	0.95	0.95	0.95
Heavy Vehicles, %	2	2	2	2	2	2	2	2	2	2	2	2
Mvmt Flow	63	21	234	21	21	21	171	192	21	21	149	74
Number of Lanes	0	1	0	0	1	0	0	1	0	0	1	0

Approach	EB	WB	NB	SB
Opposing Approach	WB	EB	SB	NB
Opposing Lanes	1	1	1	1
Conflicting Approach Left	SB	NB	EB	WB
Conflicting Lanes Left	1	1	1	1
Conflicting Approach Right	NB	SB	WB	EB
Conflicting Lanes Right	1	1	1	1
HCM Control Delay	13.1	9.9	15.9	11.8
HCM LOS	B	A	C	B

Lane	NBLn1	EBLn1	WBLn1	SBLn1
Vol Left, %	45%	20%	33%	9%
Vol Thru, %	50%	7%	33%	61%
Vol Right, %	5%	74%	33%	30%
Sign Control	Stop	Stop	Stop	Stop
Traffic Vol by Lane	364	302	60	232
LT Vol	162	60	20	20
Through Vol	182	20	20	142
RT Vol	20	222	20	70
Lane Flow Rate	383	318	63	244
Geometry Grp	1	1	1	1
Degree of Util (X)	0.581	0.472	0.107	0.371
Departure Headway (Hd)	5.46	5.341	6.121	5.468
Convergence, Y/N	Yes	Yes	Yes	Yes
Cap	659	671	582	654
Service Time	3.512	3.399	4.202	3.527
HCM Lane V/C Ratio	0.581	0.474	0.108	0.373
HCM Control Delay	15.9	13.1	9.9	11.8
HCM Lane LOS	C	B	A	B
HCM 95th-tile Q	3.7	2.5	0.4	1.7

HCM 6th TWSC  
16: Riverside Dr & Verano Ave

08/02/2020

Intersection

Int Delay, s/veh 155.2

Movement	EBL	EBT	EBR	WBL	WBT	WBR	NBL	NBT	NBR	SBL	SBT	SBR
Lane Configurations	↖	↗			↕			↕			↕	
Traffic Vol, veh/h	65	365	130	80	415	160	30	90	30	85	60	45
Future Vol, veh/h	65	365	130	80	415	160	30	90	30	85	60	45
Conflicting Peds, #/hr	0	0	0	0	0	0	0	0	0	0	0	0
Sign Control	Free	Free	Free	Free	Free	Free	Stop	Stop	Stop	Stop	Stop	Stop
RT Channelized	-	-	None	-	-	None	-	-	None	-	-	None
Storage Length	100	-	-	-	-	-	-	-	-	-	-	-
Veh in Median Storage, #	-	0	-	-	0	-	-	0	-	-	0	-
Grade, %	-	0	-	-	0	-	-	0	-	-	0	-
Peak Hour Factor	95	95	95	95	95	95	95	95	95	95	95	95
Heavy Vehicles, %	2	2	2	2	2	2	2	2	2	2	2	2
Mvmt Flow	68	384	137	84	437	168	32	95	32	89	63	47

Major/Minor	Major1	Major2	Minor1	Minor2
Conflicting Flow All	605	0	0	521
Stage 1	-	-	-	-
Stage 2	-	-	-	-
Critical Hdwy	4.12	-	-	4.12
Critical Hdwy Stg 1	-	-	-	-
Critical Hdwy Stg 2	-	-	-	-
Follow-up Hdwy	2.218	-	-	2.218
Pot Cap-1 Maneuver	973	-	-	1045
Stage 1	-	-	-	-
Stage 2	-	-	-	-
Platoon blocked, %	-	-	-	-
Mov Cap-1 Maneuver	973	-	-	1045
Mov Cap-2 Maneuver	-	-	-	-
Stage 1	-	-	-	-
Stage 2	-	-	-	-

Approach	EB	WB	NB	SB
HCM Control Delay, s	1	1.1	272.1	\$ 1048.4
HCM LOS			F	F

Minor Lane/Major Mvmt	NBLn1	EBL	EBT	EBR	WBL	WBT	WBR	SBLn1
Capacity (veh/h)	117	973	-	-	1045	-	-	66
HCM Lane V/C Ratio	1.35	0.07	-	-	0.081	-	-	3.03
HCM Control Delay (s)	272.1	9	-	-	8.7	0	-	\$ 1048.4
HCM Lane LOS	F	A	-	-	A	A	-	F
HCM 95th %tile Q(veh)	10.7	0.2	-	-	0.3	-	-	20.4

Notes  
 -: Volume exceeds capacity    \$: Delay exceeds 300s    +: Computation Not Defined    \*: All major volume in platoon

HCM 6th Signalized Intersection Summary  
 17: Main St/Petaluma Hill Rd & Old Adobe Rd/Adobe Rd

08/02/2020



Movement	EBL	EBT	EBR	WBL	WBT	WBR	NBL	NBT	NBR	SBL	SBT	SBR
Lane Configurations		↕			↕			↕		↕	↕	↕
Traffic Volume (veh/h)	51	191	80	30	265	560	60	915	30	380	416	54
Future Volume (veh/h)	51	191	80	30	265	560	60	915	30	380	416	54
Initial Q (Qb), veh	0	0	0	0	0	0	0	0	0	0	0	0
Ped-Bike Adj(A_pbT)	1.00		0.99	1.00		0.99	1.00		1.00	1.00		0.99
Parking Bus, Adj	1.00	1.00	1.00	1.00	1.00	1.00	1.00	1.00	1.00	1.00	1.00	1.00
Work Zone On Approach		No			No			No			No	
Adj Sat Flow, veh/h/ln	1870	1870	1870	1870	1870	1870	1870	1870	1870	1870	1870	1870
Adj Flow Rate, veh/h	54	201	67	32	279	494	63	963	30	400	438	51
Peak Hour Factor	0.95	0.95	0.95	0.95	0.95	0.95	0.95	0.95	0.95	0.95	0.95	0.95
Percent Heavy Veh, %	2	2	2	2	2	2	2	2	2	2	2	2
Cap, veh/h	103	349	104	62	225	379	27	419	13	318	293	34
Arrive On Green	0.37	0.37	0.37	0.37	0.37	0.37	0.25	0.25	0.25	0.18	0.18	0.18
Sat Flow, veh/h	128	934	279	37	603	1015	111	1692	53	1781	1642	191
Grp Volume(v), veh/h	322	0	0	805	0	0	1056	0	0	400	0	489
Grp Sat Flow(s),veh/h/ln	1341	0	0	1654	0	0	1855	0	0	1781	0	1833
Q Serve(g_s), s	0.0	0.0	0.0	16.1	0.0	0.0	19.0	0.0	0.0	13.7	0.0	13.7
Cycle Q Clear(g_c), s	11.5	0.0	0.0	28.7	0.0	0.0	19.0	0.0	0.0	13.7	0.0	13.7
Prop In Lane	0.17		0.21	0.04		0.61	0.06		0.03	1.00		0.10
Lane Grp Cap(c), veh/h	556	0	0	667	0	0	459	0	0	318	0	327
V/C Ratio(X)	0.58	0.00	0.00	1.21	0.00	0.00	2.30	0.00	0.00	1.26	0.00	1.50
Avail Cap(c_a), veh/h	556	0	0	667	0	0	459	0	0	318	0	327
HCM Platoon Ratio	1.00	1.00	1.00	1.00	1.00	1.00	1.00	1.00	1.00	1.00	1.00	1.00
Upstream Filter(I)	1.00	0.00	0.00	1.00	0.00	0.00	1.00	0.00	0.00	1.00	0.00	1.00
Uniform Delay (d), s/veh	18.4	0.0	0.0	25.0	0.0	0.0	28.9	0.0	0.0	31.6	0.0	31.6
Incr Delay (d2), s/veh	1.0	0.0	0.0	106.8	0.0	0.0	592.1	0.0	0.0	139.5	0.0	238.6
Initial Q Delay(d3),s/veh	0.0	0.0	0.0	0.0	0.0	0.0	0.0	0.0	0.0	0.0	0.0	0.0
%ile BackOfQ(50%),veh/ln	4.2	0.0	0.0	31.0	0.0	0.0	83.7	0.0	0.0	17.9	0.0	27.4
Unsig. Movement Delay, s/veh												
LnGrp Delay(d),s/veh	19.4	0.0	0.0	131.9	0.0	0.0	621.0	0.0	0.0	171.0	0.0	270.1
LnGrp LOS	B	A	A	F	A	A	F	A	A	F	A	F
Approach Vol, veh/h		322			805			1056				889
Approach Delay, s/veh		19.4			131.9			621.0				225.5
Approach LOS		B			F			F				F
Timer - Assigned Phs		2		4		6		8				
Phs Duration (G+Y+Rc), s		23.6		34.1		19.1		34.1				
Change Period (Y+Rc), s		4.6		* 5.4		5.4		5.4				
Max Green Setting (Gmax), s		19.0		* 24		13.7		28.7				
Max Q Clear Time (g_c+I1), s		21.0		13.5		15.7		30.7				
Green Ext Time (p_c), s		0.0		0.7		0.0		0.0				

Intersection Summary

HCM 6th Ctrl Delay	315.3
HCM 6th LOS	F

Notes

User approved pedestrian interval to be less than phase max green.  
 \* HCM 6th computational engine requires equal clearance times for the phases crossing the barrier.



# HCM 6th Signalized Intersection Summary

## 18: Old Redwood Hwy & Main St

08/02/2020



Movement	WBL	WBR	NBT	NBR	SBL	SBT
Lane Configurations	↶	↶	↕	↷	↶	↷
Traffic Volume (veh/h)	453	32	725	922	32	340
Future Volume (veh/h)	453	32	725	922	32	340
Initial Q (Qb), veh	0	0	0	0	0	0
Ped-Bike Adj(A_pbT)	1.00	1.00		1.00	1.00	
Parking Bus, Adj	1.00	1.00	1.00	1.00	1.00	1.00
Work Zone On Approach	No		No		No	
Adj Sat Flow, veh/h/ln	1870	1870	1870	1870	1870	1870
Adj Flow Rate, veh/h	477	9	763	971	34	358
Peak Hour Factor	0.95	0.95	0.95	0.95	0.95	0.95
Percent Heavy Veh, %	2	2	2	2	2	2
Cap, veh/h	519	462	813	689	49	1033
Arrive On Green	0.29	0.29	0.43	0.43	0.03	0.55
Sat Flow, veh/h	1781	1585	1870	1585	1781	1870
Grp Volume(v), veh/h	477	9	763	971	34	358
Grp Sat Flow(s),veh/h/ln	1781	1585	1870	1585	1781	1870
Q Serve(g_s), s	17.9	0.3	26.9	30.0	1.3	7.3
Cycle Q Clear(g_c), s	17.9	0.3	26.9	30.0	1.3	7.3
Prop In Lane	1.00	1.00		1.00	1.00	
Lane Grp Cap(c), veh/h	519	462	813	689	49	1033
V/C Ratio(X)	0.92	0.02	0.94	1.41	0.69	0.35
Avail Cap(c_a), veh/h	774	689	813	689	310	1033
HCM Platoon Ratio	1.00	1.00	1.00	1.00	1.00	1.00
Upstream Filter(I)	1.00	1.00	1.00	1.00	1.00	1.00
Uniform Delay (d), s/veh	23.7	17.4	18.6	19.5	33.3	8.6
Incr Delay (d2), s/veh	9.3	0.0	18.1	192.7	6.1	0.1
Initial Q Delay(d3),s/veh	0.0	0.0	0.0	0.0	0.0	0.0
%ile BackOfQ(50%),veh/ln	8.5	0.1	13.8	46.0	0.6	2.3
Unsig. Movement Delay, s/veh						
LnGrp Delay(d),s/veh	32.9	17.4	36.7	212.2	39.4	8.6
LnGrp LOS	C	B	D	F	D	A
Approach Vol, veh/h	486		1734			392
Approach Delay, s/veh	32.7		135.0			11.3
Approach LOS	C		F			B
Timer - Assigned Phs	1	2		4		6
Phs Duration (G+Y+Rc), s	36.2			24.7		44.3
Change Period (Y+Rc), s	6.2	6.2		4.6		6.2
Max Green Setting (Gmax)	30.0			30.0		30.0
Max Q Clear Time (g_c+I)	32.0			19.9		9.3
Green Ext Time (p_c), s	0.0	0.0		0.2		0.6

### Intersection Summary

HCM 6th Ctrl Delay	97.4
HCM 6th LOS	F

### Notes

User approved pedestrian interval to be less than phase max green.

HCM 6th TWSC  
 19: Private Dwy/Paula Ln & Bodega Ave

08/02/2020

Intersection												
Int Delay, s/veh	2.8											
Movement	EBL	EBT	EBR	WBL	WBT	WBR	NBL	NBT	NBR	SBL	SBT	SBR
Lane Configurations												
Traffic Vol, veh/h	30	425	5	25	515	30	5	5	20	35	10	30
Future Vol, veh/h	30	425	5	25	515	30	5	5	20	35	10	30
Conflicting Peds, #/hr	0	0	0	0	0	0	0	0	0	0	0	0
Sign Control	Free	Free	Free	Free	Free	Free	Stop	Stop	Stop	Stop	Stop	Stop
RT Channelized	-	-	None	-	-	None	-	-	None	-	-	None
Storage Length	90	-	-	90	-	-	-	-	-	-	-	-
Veh in Median Storage, #	-	0	-	-	0	-	-	0	-	-	0	-
Grade, %	-	0	-	-	0	-	-	0	-	-	0	-
Peak Hour Factor	95	95	95	95	95	95	95	95	95	95	95	95
Heavy Vehicles, %	2	2	2	2	2	2	2	2	2	2	2	2
Mvmt Flow	32	447	5	26	542	32	5	5	21	37	11	32

Major/Minor	Major1			Major2			Minor1			Minor2		
Conflicting Flow All	574	0	0	452	0	0	1146	1140	450	1137	1126	558
Stage 1	-	-	-	-	-	-	514	514	-	610	610	-
Stage 2	-	-	-	-	-	-	632	626	-	527	516	-
Critical Hdwy	4.12	-	-	4.12	-	-	7.12	6.52	6.22	7.12	6.52	6.22
Critical Hdwy Stg 1	-	-	-	-	-	-	6.12	5.52	-	6.12	5.52	-
Critical Hdwy Stg 2	-	-	-	-	-	-	6.12	5.52	-	6.12	5.52	-
Follow-up Hdwy	2.218	-	-	2.218	-	-	3.518	4.018	3.318	3.518	4.018	3.318
Pot Cap-1 Maneuver	999	-	-	1109	-	-	176	201	609	179	205	529
Stage 1	-	-	-	-	-	-	543	535	-	482	485	-
Stage 2	-	-	-	-	-	-	468	477	-	535	534	-
Platoon blocked, %	-	-	-	-	-	-	-	-	-	-	-	-
Mov Cap-1 Maneuver	999	-	-	1109	-	-	152	190	609	162	194	529
Mov Cap-2 Maneuver	-	-	-	-	-	-	152	190	-	162	194	-
Stage 1	-	-	-	-	-	-	526	518	-	467	474	-
Stage 2	-	-	-	-	-	-	420	466	-	495	517	-

Approach	EB			WB			NB			SB		
HCM Control Delay, s	0.6			0.4			17.2			28.5		
HCM LOS							C			D		

Minor Lane/Major Mvmt	NBLn1	EBL	EBT	EBR	WBL	WBT	WBR	SBLn1
Capacity (veh/h)	326	999	-	-	1109	-	-	231
HCM Lane V/C Ratio	0.097	0.032	-	-	0.024	-	-	0.342
HCM Control Delay (s)	17.2	8.7	-	-	8.3	-	-	28.5
HCM Lane LOS	C	A	-	-	A	-	-	D
HCM 95th %tile Q(veh)	0.3	0.1	-	-	0.1	-	-	1.4

HCM 6th Signalized Intersection Summary  
 20: Broadway & Leveroni Rd/Napa Rd

08/02/2020



Movement	EBL	EBT	EBR	WBL	WBT	WBR	NBL	NBT	NBR	SBL	SBT	SBR
Lane Configurations	↖	↗		↖	↗		↖	↕		↖	↗	
Traffic Volume (veh/h)	130	390	73	83	420	270	82	285	122	270	300	130
Future Volume (veh/h)	130	390	73	83	420	270	82	285	122	270	300	130
Initial Q (Qb), veh	0	0	0	0	0	0	0	0	0	0	0	0
Ped-Bike Adj(A_pbT)	1.00		1.00	1.00		1.00	1.00		0.98	1.00		0.99
Parking Bus, Adj	1.00	1.00	1.00	1.00	1.00	1.00	1.00	1.00	1.00	1.00	1.00	1.00
Work Zone On Approach		No			No			No			No	
Adj Sat Flow, veh/h/ln	1870	1870	1870	1870	1870	1870	1870	1870	1870	1870	1870	1870
Adj Flow Rate, veh/h	137	411	72	87	442	265	86	300	82	284	316	92
Peak Hour Factor	0.95	0.95	0.95	0.95	0.95	0.95	0.95	0.95	0.95	0.95	0.95	0.95
Percent Heavy Veh, %	2	2	2	2	2	2	2	2	2	2	2	2
Cap, veh/h	213	558	98	195	382	229	194	436	117	318	618	177
Arrive On Green	0.12	0.36	0.36	0.11	0.35	0.35	0.11	0.16	0.16	0.18	0.23	0.23
Sat Flow, veh/h	1781	1549	271	1781	1093	656	1781	2760	740	1781	2719	778
Grp Volume(v), veh/h	137	0	483	87	0	707	86	191	191	284	205	203
Grp Sat Flow(s),veh/h/ln	1781	0	1820	1781	0	1749	1781	1777	1723	1781	1777	1720
Q Serve(g_s), s	6.5	0.0	20.5	4.1	0.0	31.0	4.0	9.0	9.3	13.8	8.9	9.2
Cycle Q Clear(g_c), s	6.5	0.0	20.5	4.1	0.0	31.0	4.0	9.0	9.3	13.8	8.9	9.2
Prop In Lane	1.00		0.15	1.00		0.37	1.00		0.43	1.00		0.45
Lane Grp Cap(c), veh/h	213	0	655	195	0	612	194	281	272	318	404	391
V/C Ratio(X)	0.64	0.00	0.74	0.45	0.00	1.16	0.44	0.68	0.70	0.89	0.51	0.52
Avail Cap(c_a), veh/h	523	0	655	523	0	612	221	541	525	322	541	524
HCM Platoon Ratio	1.00	1.00	1.00	1.00	1.00	1.00	1.00	1.00	1.00	1.00	1.00	1.00
Upstream Filter(I)	1.00	0.00	1.00	1.00	0.00	1.00	1.00	1.00	1.00	1.00	1.00	1.00
Uniform Delay (d), s/veh	37.2	0.0	24.7	36.9	0.0	28.8	37.0	35.2	35.3	35.6	29.9	30.0
Incr Delay (d2), s/veh	3.2	0.0	4.4	1.6	0.0	87.6	1.6	2.9	3.3	25.4	1.0	1.1
Initial Q Delay(d3),s/veh	0.0	0.0	0.0	0.0	0.0	0.0	0.0	0.0	0.0	0.0	0.0	0.0
%ile BackOfQ(50%),veh/ln	2.9	0.0	8.8	1.8	0.0	26.8	1.7	3.9	3.9	8.0	3.8	3.8
Unsig. Movement Delay, s/veh												
LnGrp Delay(d),s/veh	40.4	0.0	29.1	38.5	0.0	116.4	38.5	38.1	38.6	61.0	30.9	31.1
LnGrp LOS	D	A	C	D	A	F	D	D	D	E	C	C
Approach Vol, veh/h		620			794			468			692	
Approach Delay, s/veh		31.6			107.8			38.4			43.3	
Approach LOS		C			F			D			D	
Timer - Assigned Phs	1	2	3	4	5	6	7	8				
Phs Duration (G+Y+Rc), s	13.7	25.1	14.6	35.2	19.8	19.0	13.7	36.1				
Change Period (Y+Rc), s	4.0	5.0	4.0	* 4.2	4.0	5.0	4.0	* 4.2				
Max Green Setting (Gmax), s	11.0	27.0	26.0	* 31	16.0	27.0	26.0	* 31				
Max Q Clear Time (g_c+I1), s	6.0	11.2	8.5	33.0	15.8	11.3	6.1	22.5				
Green Ext Time (p_c), s	0.1	2.1	0.3	0.0	0.0	1.8	0.2	1.8				

Intersection Summary

HCM 6th Ctrl Delay	59.5
HCM 6th LOS	E

Notes

\* HCM 6th computational engine requires equal clearance times for the phases crossing the barrier.













**ATTACHMENT C-5**

**MITIGATED CONDITIONS OUPUTS**



HCM 6th Signalized Intersection Summary  
 4: Old Redwood Hwy & Fulton Rd

Cumulative plus Project Conditions AM

						
Movement	EBL	EBR	NBL	NBT	SBT	SBR
Lane Configurations						
Traffic Volume (veh/h)	182	40	40	194	866	408
Future Volume (veh/h)	182	40	40	194	866	408
Initial Q (Qb), veh	0	0	0	0	0	0
Ped-Bike Adj(A_pbT)	1.00	1.00	1.00			1.00
Parking Bus, Adj	1.00	1.00	1.00	1.00	1.00	1.00
Work Zone On Approach	No			No	No	
Adj Sat Flow, veh/h/ln	1870	1870	1870	1870	1870	1870
Adj Flow Rate, veh/h	192	42	42	204	912	429
Peak Hour Factor	0.95	0.95	0.95	0.95	0.95	0.95
Percent Heavy Veh, %	2	2	2	2	2	2
Cap, veh/h	255	227	76	1306	1078	913
Arrive On Green	0.14	0.14	0.04	0.70	0.58	0.58
Sat Flow, veh/h	1781	1585	1781	1870	1870	1585
Grp Volume(v), veh/h	192	42	42	204	912	429
Grp Sat Flow(s),veh/h/ln	1781	1585	1781	1870	1870	1585
Q Serve(g_s), s	5.9	1.3	1.3	2.1	22.9	8.9
Cycle Q Clear(g_c), s	5.9	1.3	1.3	2.1	22.9	8.9
Prop In Lane	1.00	1.00	1.00			1.00
Lane Grp Cap(c), veh/h	255	227	76	1306	1078	913
V/C Ratio(X)	0.75	0.18	0.55	0.16	0.85	0.47
Avail Cap(c_a), veh/h	565	503	157	1747	1434	1215
HCM Platoon Ratio	1.00	1.00	1.00	1.00	1.00	1.00
Upstream Filter(I)	1.00	1.00	1.00	1.00	1.00	1.00
Uniform Delay (d), s/veh	23.3	21.4	26.6	2.9	9.9	7.0
Incr Delay (d2), s/veh	4.5	0.4	6.1	0.1	3.7	0.4
Initial Q Delay(d3),s/veh	0.0	0.0	0.0	0.0	0.0	0.0
%ile BackOfQ(50%),veh/ln	2.6	1.3	0.6	0.4	6.7	1.9
Unsig. Movement Delay, s/veh						
LnGrp Delay(d),s/veh	27.8	21.8	32.8	3.0	13.7	7.4
LnGrp LOS	C	C	C	A	B	A
Approach Vol, veh/h	234			246	1341	
Approach Delay, s/veh	26.7			8.0	11.7	
Approach LOS	C			A	B	
Timer - Assigned Phs		2		4	5	6
Phs Duration (G+Y+Rc), s		44.1		12.6	6.9	37.2
Change Period (Y+Rc), s		4.5		4.5	4.5	4.5
Max Green Setting (Gmax), s		53.0		18.0	5.0	43.5
Max Q Clear Time (g_c+I1), s		4.1		7.9	3.3	24.9
Green Ext Time (p_c), s		1.2		0.5	0.0	7.8
<b>Intersection Summary</b>						
HCM 6th Ctrl Delay			13.1			
HCM 6th LOS			B			

HCM 6th Roundabout  
4: Old Redwood Hwy & Fulton Rd























Cumulative plus Project Conditions AM

Intersection				
Intersection Delay, s/veh	9.7			
Intersection LOS	A			
Approach	EB	NB	SB	
Entry Lanes	1	1	2	
Conflicting Circle Lanes	1	1	1	
Adj Approach Flow, veh/h	234	246	1341	
Demand Flow Rate, veh/h	239	251	1368	
Vehicles Circulating, veh/h	930	196	43	
Vehicles Exiting, veh/h	481	973	404	
Ped Vol Crossing Leg, #/h	0	0	0	
Ped Cap Adj	1.000	1.000	1.000	
Approach Delay, s/veh	14.6	5.3	9.7	
Approach LOS	B	A	A	
Lane	Left	Left	Left	Right
Designated Moves	LR	LT	LT	R
Assumed Moves	LR	LT	LT	R
RT Channelized				
Lane Util	1.000	1.000	0.680	0.320
Follow-Up Headway, s	2.609	2.609	2.535	2.535
Critical Headway, s	4.976	4.976	4.544	4.544
Entry Flow, veh/h	239	251	930	438
Cap Entry Lane, veh/h	534	1130	1366	1366
Entry HV Adj Factor	0.979	0.980	0.980	0.979
Flow Entry, veh/h	234	246	912	429
Cap Entry, veh/h	523	1107	1339	1338
V/C Ratio	0.447	0.222	0.681	0.321
Control Delay, s/veh	14.6	5.3	11.6	5.6
LOS	B	A	B	A
95th %tile Queue, veh	2	1	6	1

# HCM 6th Signalized Intersection Summary

## 5: Fulton Rd & Airport Blvd

Cumulative plus Project Conditions AM

												
Movement	EBL	EBT	EBR	WBL	WBT	WBR	NBL	NBT	NBR	SBL	SBT	SBR
Lane Configurations												
Traffic Volume (veh/h)	81	341	210	232	623	30	720	181	161	40	282	266
Future Volume (veh/h)	81	341	210	232	623	30	720	181	161	40	282	266
Initial Q (Qb), veh	0	0	0	0	0	0	0	0	0	0	0	0
Ped-Bike Adj(A_pbT)	1.00		0.99	1.00		0.99	1.00		0.99	1.00		0.99
Parking Bus, Adj	1.00	1.00	1.00	1.00	1.00	1.00	1.00	1.00	1.00	1.00	1.00	1.00
Work Zone On Approach		No			No			No			No	
Adj Sat Flow, veh/h/ln	1870	1870	1870	1870	1870	1870	1870	1870	1870	1870	1870	1870
Adj Flow Rate, veh/h	85	359	41	244	656	31	758	191	35	42	297	255
Peak Hour Factor	0.95	0.95	0.95	0.95	0.95	0.95	0.95	0.95	0.95	0.95	0.95	0.95
Percent Heavy Veh, %	2	2	2	2	2	2	2	2	2	2	2	2
Cap, veh/h	69	421	353	140	465	22	514	540	454	33	231	199
Arrive On Green	0.04	0.22	0.22	0.08	0.26	0.26	0.29	0.29	0.29	0.27	0.27	0.27
Sat Flow, veh/h	1781	1870	1567	1781	1771	84	1781	1870	1571	122	863	741
Grp Volume(v), veh/h	85	359	41	244	0	687	758	191	35	594	0	0
Grp Sat Flow(s),veh/h/ln	1781	1870	1567	1781	0	1854	1781	1870	1571	1726	0	0
Q Serve(g_s), s	6.2	29.5	3.3	12.6	0.0	42.0	46.2	12.9	2.6	42.9	0.0	0.0
Cycle Q Clear(g_c), s	6.2	29.5	3.3	12.6	0.0	42.0	46.2	12.9	2.6	42.9	0.0	0.0
Prop In Lane	1.00		1.00	1.00		0.05	1.00		1.00	0.07		0.43
Lane Grp Cap(c), veh/h	69	421	353	140	0	487	514	540	454	463	0	0
V/C Ratio(X)	1.23	0.85	0.12	1.74	0.00	1.41	1.47	0.35	0.08	1.28	0.00	0.00
Avail Cap(c_a), veh/h	69	421	353	140	0	487	514	540	454	463	0	0
HCM Platoon Ratio	1.00	1.00	1.00	1.00	1.00	1.00	1.00	1.00	1.00	1.00	1.00	1.00
Upstream Filter(I)	1.00	1.00	1.00	1.00	0.00	1.00	1.00	1.00	1.00	1.00	0.00	0.00
Uniform Delay (d), s/veh	76.9	59.5	49.3	73.7	0.0	59.0	56.9	45.1	41.4	58.6	0.0	0.0
Incr Delay (d2), s/veh	183.1	14.8	0.1	360.6	0.0	197.0	223.5	0.1	0.0	143.3	0.0	0.0
Initial Q Delay(d3),s/veh	0.0	0.0	0.0	0.0	0.0	0.0	0.0	0.0	0.0	0.0	0.0	0.0
%ile BackOfQ(50%),veh/ln	6.3	15.5	1.3	19.8	0.0	46.1	52.2	6.0	1.0	37.0	0.0	0.0
Unsig. Movement Delay, s/veh												
LnGrp Delay(d),s/veh	260.0	74.3	49.4	434.3	0.0	256.0	280.4	45.2	41.4	201.8	0.0	0.0
LnGrp LOS	F	E	D	F	A	F	F	D	D	F	A	A
Approach Vol, veh/h		485			931			984			594	
Approach Delay, s/veh		104.7			302.7			226.3			201.8	
Approach LOS		F			F			F			F	
Timer - Assigned Phs	1	2		4	5	6		8				
Phs Duration (G+Y+Rc), s	18.0	42.0		48.0	12.0	48.0		52.0				
Change Period (Y+Rc), s	5.4	6.0		5.1	5.8	6.0		5.8				
Max Green Setting (Gmax), s	12.6	36.0		42.9	6.2	42.0		46.2				
Max Q Clear Time (g_c+I1), s	14.6	31.5		44.9	8.2	44.0		48.2				
Green Ext Time (p_c), s	0.0	0.6		0.0	0.0	0.0		0.0				

### Intersection Summary



















HCM 6th Ctrl Delay	225.5
HCM 6th LOS	F

### Notes

User approved pedestrian interval to be less than phase max green.

HCM 6th Signalized Intersection Summary  
 7: Old Redwood Hwy & Creekside Apts/Faught Rd

Cumulative plus Project Conditions AM

												
Movement	EBL	EBT	EBR	WBL	WBT	WBR	NBL	NBT	NBR	SBL	SBT	SBR
Lane Configurations												
Traffic Volume (veh/h)	60	20	30	182	20	20	20	437	110	30	1108	30
Future Volume (veh/h)	60	20	30	182	20	20	20	437	110	30	1108	30
Initial Q (Qb), veh	0	0	0	0	0	0	0	0	0	0	0	0
Ped-Bike Adj(A_pbT)	1.00		1.00	1.00		1.00	1.00		1.00	1.00		1.00
Parking Bus, Adj	1.00	1.00	1.00	1.00	1.00	1.00	1.00	1.00	1.00	1.00	1.00	1.00
Work Zone On Approach		No			No			No			No	
Adj Sat Flow, veh/h/ln	1870	1870	1870	1870	1870	1870	1870	1870	1870	1870	1870	1870
Adj Flow Rate, veh/h	63	21	32	192	21	21	21	460	116	32	1166	32
Peak Hour Factor	0.95	0.95	0.95	0.95	0.95	0.95	0.95	0.95	0.95	0.95	0.95	0.95
Percent Heavy Veh, %	2	2	2	2	2	2	2	2	2	2	2	2
Cap, veh/h	77	26	39	207	23	23	36	1147	972	47	1122	31
Arrive On Green	0.08	0.08	0.08	0.14	0.14	0.14	0.02	0.61	0.61	0.03	0.62	0.62
Sat Flow, veh/h	943	314	479	1452	159	159	1781	1870	1585	1781	1812	50
Grp Volume(v), veh/h	116	0	0	234	0	0	21	460	116	32	0	1198
Grp Sat Flow(s),veh/h/ln	1737	0	0	1769	0	0	1781	1870	1585	1781	0	1861
Q Serve(g_s), s	8.7	0.0	0.0	17.3	0.0	0.0	1.5	16.7	4.0	2.4	0.0	82.1
Cycle Q Clear(g_c), s	8.7	0.0	0.0	17.3	0.0	0.0	1.5	16.7	4.0	2.4	0.0	82.1
Prop In Lane	0.54		0.28	0.82		0.09	1.00		1.00	1.00		0.03
Lane Grp Cap(c), veh/h	143	0	0	252	0	0	36	1147	972	47	0	1153
V/C Ratio(X)	0.81	0.00	0.00	0.93	0.00	0.00	0.58	0.40	0.12	0.69	0.00	1.04
Avail Cap(c_a), veh/h	255	0	0	252	0	0	155	1158	982	155	0	1153
HCM Platoon Ratio	1.00	1.00	1.00	1.00	1.00	1.00	1.00	1.00	1.00	1.00	1.00	1.00
Upstream Filter(I)	1.00	0.00	0.00	1.00	0.00	0.00	1.00	1.00	1.00	1.00	0.00	1.00
Uniform Delay (d), s/veh	59.8	0.0	0.0	56.2	0.0	0.0	64.4	13.1	10.7	64.0	0.0	25.2
Incr Delay (d2), s/veh	10.5	0.0	0.0	37.7	0.0	0.0	13.9	0.2	0.1	16.5	0.0	37.3
Initial Q Delay(d3),s/veh	0.0	0.0	0.0	0.0	0.0	0.0	0.0	0.0	0.0	0.0	0.0	0.0
%ile BackOfQ(50%),veh/ln	4.3	0.0	0.0	10.3	0.0	0.0	0.8	6.9	1.4	1.3	0.0	45.0
Unsig. Movement Delay, s/veh												
LnGrp Delay(d),s/veh	70.4	0.0	0.0	93.8	0.0	0.0	78.2	13.4	10.7	80.5	0.0	62.5
LnGrp LOS	E	A	A	F	A	A	E	B	B	F	A	F
Approach Vol, veh/h		116			234			597			1230	
Approach Delay, s/veh		70.4			93.8			15.1			63.0	
Approach LOS		E			F			B			E	
Timer - Assigned Phs		2	3	4		6	7	8				
Phs Duration (G+Y+Rc), s		15.4	8.0	85.8		23.4	7.2	86.6				
Change Period (Y+Rc), s		4.5	4.5	4.5		4.5	4.5	4.5				
Max Green Setting (Gmax), s		19.5	11.5	82.1		18.9	11.5	82.1				
Max Q Clear Time (g_c+I1), s		10.7	4.4	18.7		19.3	3.5	84.1				
Green Ext Time (p_c), s		0.3	0.0	3.5		0.0	0.0	0.0				
<b>Intersection Summary</b>												
HCM 6th Ctrl Delay				53.6								
HCM 6th LOS				D								



HCM 6th Signalized Intersection Summary  
 9: Pocket Canyon Hwy/Front St & Mirabel Rd

Cumulative plus Project Conditions AM



Movement	EBL	EBT	WBT	WBR	SBL	SBR
Lane Configurations		↕	↑	↗	↖	↗
Traffic Volume (veh/h)	105	375	225	236	512	43
Future Volume (veh/h)	105	375	225	236	512	43
Initial Q (Qb), veh	0	0	0	0	0	0
Ped-Bike Adj(A_pbT)	1.00			1.00	1.00	1.00
Parking Bus, Adj	1.00	1.00	1.00	1.00	1.00	1.00
Work Zone On Approach		No	No		No	
Adj Sat Flow, veh/h/ln	1870	1870	1870	1870	1870	1870
Adj Flow Rate, veh/h	111	395	237	248	539	45
Peak Hour Factor	0.95	0.95	0.95	0.95	0.95	0.95
Percent Heavy Veh, %	2	2	2	2	2	2
Cap, veh/h	213	540	743	630	659	586
Arrive On Green	0.40	0.40	0.40	0.40	0.37	0.37
Sat Flow, veh/h	249	1359	1870	1585	1781	1585
Grp Volume(v), veh/h	506	0	237	248	539	45
Grp Sat Flow(s),veh/h/ln	1608	0	1870	1585	1781	1585
Q Serve(g_s), s	6.4	0.0	3.4	4.3	10.6	0.7
Cycle Q Clear(g_c), s	10.3	0.0	3.4	4.3	10.6	0.7
Prop In Lane	0.22			1.00	1.00	1.00
Lane Grp Cap(c), veh/h	752	0	743	630	659	586
V/C Ratio(X)	0.67	0.00	0.32	0.39	0.82	0.08
Avail Cap(c_a), veh/h	1348	0	1477	1251	1406	1251
HCM Platoon Ratio	1.00	1.00	1.00	1.00	1.00	1.00
Upstream Filter(I)	1.00	0.00	1.00	1.00	1.00	1.00
Uniform Delay (d), s/veh	9.9	0.0	8.0	8.3	11.0	7.9
Incr Delay (d2), s/veh	1.1	0.0	0.2	0.4	2.6	0.1
Initial Q Delay(d3),s/veh	0.0	0.0	0.0	0.0	0.0	0.0
%ile BackOfQ(50%),veh/ln	2.2	0.0	1.1	1.2	2.9	0.2
Unsig. Movement Delay, s/veh						
LnGrp Delay(d),s/veh	10.9	0.0	8.3	8.7	13.6	8.0
LnGrp LOS	B	A	A	A	B	A
Approach Vol, veh/h		506	485		584	
Approach Delay, s/veh		10.9	8.5		13.2	
Approach LOS		B	A		B	
Timer - Assigned Phs				4	6	8
Phs Duration (G+Y+Rc), s				19.9	18.8	19.9
Change Period (Y+Rc), s				4.5	4.5	4.5
Max Green Setting (Gmax), s				30.5	30.5	30.5
Max Q Clear Time (g_c+I1), s				12.3	12.6	6.3
Green Ext Time (p_c), s				3.1	1.7	2.4
<b>Intersection Summary</b>						
HCM 6th Ctrl Delay			11.0			
HCM 6th LOS			B			





















HCM 6th Roundabout  
 9: Pocket Canyon Hwy/Front St & Mirabel Rd

Cumulative plus Project Conditions AM

Intersection			
Intersection Delay, s/veh	11.2		
Intersection LOS	B		
Approach	EB	WB	SB
Entry Lanes	1	1	1
Conflicting Circle Lanes	1	1	1
Adj Approach Flow, veh/h	506	485	584
Demand Flow Rate, veh/h	516	495	596
Vehicles Circulating, veh/h	550	113	242
Vehicles Exiting, veh/h	288	953	366
Ped Vol Crossing Leg, #/h	0	0	0
Ped Cap Adj	1.000	1.000	1.000
Approach Delay, s/veh	16.3	7.0	10.3
Approach LOS	C	A	B
Lane	Left	Left	Left
Designated Moves	LT	TR	LR
Assumed Moves	LT	TR	LR
RT Channelized			
Lane Util	1.000	1.000	1.000
Follow-Up Headway, s	2.609	2.609	2.609
Critical Headway, s	4.976	4.976	4.976
Entry Flow, veh/h	516	495	596
Cap Entry Lane, veh/h	787	1230	1078
Entry HV Adj Factor	0.981	0.980	0.980
Flow Entry, veh/h	506	485	584
Cap Entry, veh/h	772	1205	1056
V/C Ratio	0.655	0.403	0.553
Control Delay, s/veh	16.3	7.0	10.3
LOS	C	A	B
95th %tile Queue, veh	5	2	4

HCM 6th Signalized Intersection Summary  
 11: Private Dwy/Moorland Ave & Todd Rd





















Cumulative plus Project Conditions AM

												
Movement	EBL	EBT	EBR	WBL	WBT	WBR	NBL	NBT	NBR	SBL	SBT	SBR
Lane Configurations												
Traffic Volume (veh/h)	72	549	20	20	535	409	20	20	20	385	20	92
Future Volume (veh/h)	72	549	20	20	535	409	20	20	20	385	20	92
Initial Q (Qb), veh	0	0	0	0	0	0	0	0	0	0	0	0
Ped-Bike Adj(A_pbT)	1.00		1.00	1.00		1.00	1.00		1.00	1.00		1.00
Parking Bus, Adj	1.00	1.00	1.00	1.00	1.00	1.00	1.00	1.00	1.00	1.00	1.00	1.00
Work Zone On Approach		No			No			No			No	
Adj Sat Flow, veh/h/ln	1870	1870	1870	1870	1870	1870	1870	1870	1870	1870	1870	1870
Adj Flow Rate, veh/h	76	578	21	21	563	431	21	21	21	405	21	97
Peak Hour Factor	0.95	0.95	0.95	0.95	0.95	0.95	0.95	0.95	0.95	0.95	0.95	0.95
Percent Heavy Veh, %	2	2	2	2	2	2	2	2	2	2	2	2
Cap, veh/h	98	728	26	42	701	594	28	28	28	487	25	455
Arrive On Green	0.05	0.41	0.41	0.02	0.37	0.37	0.05	0.05	0.05	0.29	0.29	0.29
Sat Flow, veh/h	1781	1793	65	1781	1870	1585	579	579	579	1697	88	1585
Grp Volume(v), veh/h	76	0	599	21	563	431	63	0	0	426	0	97
Grp Sat Flow(s),veh/h/ln	1781	0	1859	1781	1870	1585	1737	0	0	1785	0	1585
Q Serve(g_s), s	3.2	0.0	21.6	0.9	20.6	17.9	2.7	0.0	0.0	17.1	0.0	3.6
Cycle Q Clear(g_c), s	3.2	0.0	21.6	0.9	20.6	17.9	2.7	0.0	0.0	17.1	0.0	3.6
Prop In Lane	1.00		0.04	1.00		1.00	0.33		0.33	0.95		1.00
Lane Grp Cap(c), veh/h	98	0	755	42	701	594	84	0	0	512	0	455
V/C Ratio(X)	0.78	0.00	0.79	0.50	0.80	0.73	0.75	0.00	0.00	0.83	0.00	0.21
Avail Cap(c_a), veh/h	175	0	1991	140	1967	1667	170	0	0	851	0	756
HCM Platoon Ratio	1.00	1.00	1.00	1.00	1.00	1.00	1.00	1.00	1.00	1.00	1.00	1.00
Upstream Filter(I)	1.00	0.00	1.00	1.00	1.00	1.00	1.00	0.00	0.00	1.00	0.00	1.00
Uniform Delay (d), s/veh	35.7	0.0	19.9	36.9	21.4	20.6	36.0	0.0	0.0	25.6	0.0	20.7
Incr Delay (d2), s/veh	12.3	0.0	1.9	9.0	2.2	1.7	12.7	0.0	0.0	3.6	0.0	0.2
Initial Q Delay(d3),s/veh	0.0	0.0	0.0	0.0	0.0	0.0	0.0	0.0	0.0	0.0	0.0	0.0
%ile BackOfQ(50%),veh/ln	1.7	0.0	8.8	0.5	8.6	6.3	1.4	0.0	0.0	7.4	0.0	1.3
Unsig. Movement Delay, s/veh												
LnGrp Delay(d),s/veh	48.0	0.0	21.9	45.9	23.6	22.3	48.6	0.0	0.0	29.1	0.0	21.0
LnGrp LOS	D	A	C	D	C	C	D	A	A	C	A	C
Approach Vol, veh/h		675			1015			63			523	
Approach Delay, s/veh		24.8			23.5			48.6			27.6	
Approach LOS		C			C			D			C	
Timer - Assigned Phs		2	3	4		6	7	8				
Phs Duration (G+Y+Rc), s		8.2	6.3	35.6		26.5	8.7	33.2				
Change Period (Y+Rc), s		4.5	4.5	4.5		4.5	4.5	4.5				
Max Green Setting (Gmax), s		7.5	6.0	82.0		36.5	7.5	80.5				
Max Q Clear Time (g_c+I1), s		4.7	2.9	23.6		19.1	5.2	22.6				
Green Ext Time (p_c), s		0.0	0.0	4.5		2.9	0.0	6.1				
<b>Intersection Summary</b>												
HCM 6th Ctrl Delay			25.5									
HCM 6th LOS			C									

# HCM 6th Signalized Intersection Summary

## 12: S Moreland Ave & Todd Rd

Cumulative plus Project Conditions AM

												
Movement	EBL	EBT	EBR	WBL	WBT	WBR	NBL	NBT	NBR	SBL	SBT	SBR
Lane Configurations												
Traffic Volume (veh/h)	0	530	424	420	337	0	627	0	207	0	0	0
Future Volume (veh/h)	0	530	424	420	337	0	627	0	207	0	0	0
Initial Q (Qb), veh	0	0	0	0	0	0	0	0	0	0	0	0
Ped-Bike Adj(A_pbT)	1.00		1.00	1.00		1.00	1.00		1.00	1.00		1.00
Parking Bus, Adj	1.00	1.00	1.00	1.00	1.00	1.00	1.00	1.00	1.00	1.00	1.00	1.00
Work Zone On Approach		No			No			No			No	
Adj Sat Flow, veh/h/ln	984	1870	1870	1870	1870	1870	1870	1870	1870	1870	1870	1870
Adj Flow Rate, veh/h	0	558	446	442	355	0	660	0	146	0	0	0
Peak Hour Factor	0.95	0.95	0.95	0.95	0.95	0.95	0.95	0.95	0.95	0.95	0.95	0.95
Percent Heavy Veh, %	2	2	2	2	2	2	2	2	2	2	2	2
Cap, veh/h	0	667	932	524	550	0	824	0	366	0	2	0
Arrive On Green	0.00	0.36	0.36	0.29	0.29	0.00	0.23	0.00	0.23	0.00	0.00	0.00
Sat Flow, veh/h	0	1870	1585	1781	1870	0	3563	0	1585	0	1870	0
Grp Volume(v), veh/h	0	558	446	442	355	0	660	0	146	0	0	0
Grp Sat Flow(s),veh/h/ln	0	1870	1585	1781	1870	0	1781	0	1585	0	1870	0
Q Serve(g_s), s	0.0	21.3	12.6	18.1	12.9	0.0	13.6	0.0	6.1	0.0	0.0	0.0
Cycle Q Clear(g_c), s	0.0	21.3	12.6	18.1	12.9	0.0	13.6	0.0	6.1	0.0	0.0	0.0
Prop In Lane	0.00		1.00	1.00		0.00	1.00		1.00	0.00		0.00
Lane Grp Cap(c), veh/h	0	667	932	524	550	0	824	0	366	0	2	0
V/C Ratio(X)	0.00	0.84	0.48	0.84	0.65	0.00	0.80	0.00	0.40	0.00	0.00	0.00
Avail Cap(c_a), veh/h	0	885	1116	710	745	0	1190	0	530	0	96	0
HCM Platoon Ratio	1.00	1.00	1.00	1.00	1.00	1.00	1.00	1.00	1.00	1.00	1.00	1.00
Upstream Filter(I)	0.00	1.00	1.00	1.00	1.00	0.00	1.00	0.00	1.00	0.00	0.00	0.00
Uniform Delay (d), s/veh	0.0	22.9	9.2	25.8	23.9	0.0	28.2	0.0	25.3	0.0	0.0	0.0
Incr Delay (d2), s/veh	0.0	5.4	0.4	6.9	1.3	0.0	2.6	0.0	0.7	0.0	0.0	0.0
Initial Q Delay(d3),s/veh	0.0	0.0	0.0	0.0	0.0	0.0	0.0	0.0	0.0	0.0	0.0	0.0
%ile BackOfQ(50%),veh/ln	0.0	9.6	6.8	8.2	5.5	0.0	5.9	0.0	2.3	0.0	0.0	0.0
Unsig. Movement Delay, s/veh												
LnGrp Delay(d),s/veh	0.0	28.4	9.6	32.7	25.2	0.0	30.8	0.0	26.0	0.0	0.0	0.0
LnGrp LOS	A	C	A	C	C	A	C	A	C	A	A	A
Approach Vol, veh/h		1004			797			806				0
Approach Delay, s/veh		20.0			29.4			29.9				0.0
Approach LOS		C			C			C				
Timer - Assigned Phs		2		4		6		8				
Phs Duration (G+Y+Rc), s		0.0		30.9		21.0		25.9				
Change Period (Y+Rc), s		3.0		3.2		3.0		3.0				
Max Green Setting (Gmax), s		4.0		36.8		26.0		31.0				
Max Q Clear Time (g_c+I1), s		0.0		23.3		15.6		20.1				
Green Ext Time (p_c), s		0.0		4.5		2.4		2.7				

### Intersection Summary

HCM 6th Ctrl Delay	25.9
HCM 6th LOS	C

### Notes

- User approved pedestrian interval to be less than phase max green.
- User approved volume balancing among the lanes for turning movement.

HCM 6th Roundabout  
16: Riverside Dr & Verano Ave

Cumulative plus Project Conditions AM

Intersection				
Intersection Delay, s/veh	7.3			
Intersection LOS	A			
Approach	EB	WB	NB	SB
Entry Lanes	1	1	1	1
Conflicting Circle Lanes	1	1	1	1
Adj Approach Flow, veh/h	392	475	96	247
Demand Flow Rate, veh/h	399	484	99	252
Vehicles Circulating, veh/h	298	122	536	451
Vehicles Exiting, veh/h	405	513	161	155
Ped Vol Crossing Leg, #/h	0	0	0	0
Ped Cap Adj	1.000	1.000	1.000	1.000
Approach Delay, s/veh	7.9	7.0	5.9	7.4
Approach LOS	A	A	A	A
Lane	Left	Left	Left	Left
Designated Moves	LTR	LTR	LTR	LTR
Assumed Moves	LTR	LTR	LTR	LTR
RT Channelized				
Lane Util	1.000	1.000	1.000	1.000
Follow-Up Headway, s	2.609	2.609	2.609	2.609
Critical Headway, s	4.976	4.976	4.976	4.976
Entry Flow, veh/h	399	484	99	252
Cap Entry Lane, veh/h	1018	1218	799	871
Entry HV Adj Factor	0.982	0.981	0.973	0.982
Flow Entry, veh/h	392	475	96	247
Cap Entry, veh/h	1000	1196	777	855
V/C Ratio	0.392	0.397	0.124	0.289
Control Delay, s/veh	7.9	7.0	5.9	7.4
LOS	A	A	A	A
95th %tile Queue, veh	2	2	0	1

HCM 6th Signalized Intersection Summary  
 17: Main St/Petaluma Hill Rd & Old Adobe Rd/Adobe Rd

Cumulative plus Project Conditions AM



Movement	EBL	EBT	EBR	WBL	WBT	WBR	NBL	NBT	NBR	SBL	SBT	SBR
Lane Configurations		↕			↕			↕		↕	↕	↕
Traffic Volume (veh/h)	64	264	100	20	132	410	60	283	20	510	664	71
Future Volume (veh/h)	64	264	100	20	132	410	60	283	20	510	664	71
Initial Q (Qb), veh	0	0	0	0	0	0	0	0	0	0	0	0
Ped-Bike Adj(A_pbT)	1.00		0.99	1.00		0.99	1.00		1.00	1.00		0.99
Parking Bus, Adj	1.00	1.00	1.00	1.00	1.00	1.00	1.00	1.00	1.00	1.00	1.00	1.00
Work Zone On Approach		No			No			No			No	
Adj Sat Flow, veh/h/ln	1870	1870	1870	1870	1870	1870	1870	1870	1870	1870	1870	1870
Adj Flow Rate, veh/h	67	278	105	21	139	432	63	298	21	537	699	75
Peak Hour Factor	0.95	0.95	0.95	0.95	0.95	0.95	0.95	0.95	0.95	0.95	0.95	0.95
Percent Heavy Veh, %	2	2	2	2	2	2	2	2	2	2	2	2
Cap, veh/h	72	241	85	42	138	403	54	255	18	646	601	65
Arrive On Green	0.33	0.33	0.33	0.33	0.33	0.33	0.18	0.18	0.18	0.36	0.36	0.36
Sat Flow, veh/h	112	725	255	33	417	1214	303	1433	101	1781	1659	178
Grp Volume(v), veh/h	450	0	0	592	0	0	382	0	0	537	0	774
Grp Sat Flow(s),veh/h/ln	1092	0	0	1664	0	0	1837	0	0	1781	0	1837
Q Serve(g_s), s	0.0	0.0	0.0	0.0	0.0	0.0	21.4	0.0	0.0	33.1	0.0	43.6
Cycle Q Clear(g_c), s	39.9	0.0	0.0	39.9	0.0	0.0	21.4	0.0	0.0	33.1	0.0	43.6
Prop In Lane	0.15		0.23	0.04		0.73	0.16		0.05	1.00		0.10
Lane Grp Cap(c), veh/h	397	0	0	583	0	0	327	0	0	646	0	666
V/C Ratio(X)	1.13	0.00	0.00	1.02	0.00	0.00	1.17	0.00	0.00	0.83	0.00	1.16
Avail Cap(c_a), veh/h	397	0	0	583	0	0	327	0	0	646	0	666
HCM Platoon Ratio	1.00	1.00	1.00	1.00	1.00	1.00	1.00	1.00	1.00	1.00	1.00	1.00
Upstream Filter(I)	1.00	0.00	0.00	1.00	0.00	0.00	1.00	0.00	0.00	1.00	0.00	1.00
Uniform Delay (d), s/veh	39.7	0.0	0.0	41.4	0.0	0.0	49.5	0.0	0.0	35.0	0.0	38.4
Incr Delay (d2), s/veh	87.1	0.0	0.0	41.3	0.0	0.0	103.9	0.0	0.0	8.6	0.0	89.1
Initial Q Delay(d3),s/veh	0.0	0.0	0.0	0.0	0.0	0.0	0.0	0.0	0.0	0.0	0.0	0.0
%ile BackOfQ(50%),veh/ln	21.5	0.0	0.0	23.7	0.0	0.0	19.3	0.0	0.0	15.5	0.0	35.5
Unsig. Movement Delay, s/veh												
LnGrp Delay(d),s/veh	126.8	0.0	0.0	82.7	0.0	0.0	153.4	0.0	0.0	43.6	0.0	127.4
LnGrp LOS	F	A	A	F	A	A	F	A	A	D	A	F
Approach Vol, veh/h		450			592			382				1311
Approach Delay, s/veh		126.8			82.7			153.4				93.1
Approach LOS		F			F			F				F
Timer - Assigned Phs		2		4		6		8				
Phs Duration (G+Y+Rc), s		26.0		45.3		49.0		45.3				
Change Period (Y+Rc), s		4.6		* 5.4		5.4		5.4				
Max Green Setting (Gmax), s		21.4		* 40		43.6		39.6				
Max Q Clear Time (g_c+I1), s		23.4		41.9		45.6		41.9				
Green Ext Time (p_c), s		0.0		0.0		0.0		0.0				

Intersection Summary

HCM 6th Ctrl Delay	104.8
HCM 6th LOS	F

Notes

- User approved pedestrian interval to be less than phase max green.
- \* HCM 6th computational engine requires equal clearance times for the phases crossing the barrier.

# HCM 6th Signalized Intersection Summary

## 4: Old Redwood Hwy & Fulton Rd

08/02/2020



Movement	EBL	EBR	NBL	NBT	SBT	SBR
Lane Configurations						
Traffic Volume (veh/h)	412	80	60	804	645	325
Future Volume (veh/h)	412	80	60	804	645	325
Initial Q (Qb), veh	0	0	0	0	0	0
Ped-Bike Adj(A_pbT)	1.00	1.00	1.00			1.00
Parking Bus, Adj	1.00	1.00	1.00	1.00	1.00	1.00
Work Zone On Approach	No			No	No	
Adj Sat Flow, veh/h/ln	1870	1870	1870	1870	1870	1870
Adj Flow Rate, veh/h	434	84	63	846	679	342
Peak Hour Factor	0.95	0.95	0.95	0.95	0.95	0.95
Percent Heavy Veh, %	2	2	2	2	2	2
Cap, veh/h	501	446	98	1052	802	680
Arrive On Green	0.28	0.28	0.06	0.56	0.43	0.43
Sat Flow, veh/h	1781	1585	1781	1870	1870	1585
Grp Volume(v), veh/h	434	84	63	846	679	342
Grp Sat Flow(s),veh/h/ln	1781	1585	1781	1870	1870	1585
Q Serve(g_s), s	13.3	2.3	2.0	20.8	18.7	9.0
Cycle Q Clear(g_c), s	13.3	2.3	2.0	20.8	18.7	9.0
Prop In Lane	1.00	1.00	1.00			1.00
Lane Grp Cap(c), veh/h	501	446	98	1052	802	680
V/C Ratio(X)	0.87	0.19	0.64	0.80	0.85	0.50
Avail Cap(c_a), veh/h	635	565	155	1317	1008	854
HCM Platoon Ratio	1.00	1.00	1.00	1.00	1.00	1.00
Upstream Filter(I)	1.00	1.00	1.00	1.00	1.00	1.00
Uniform Delay (d), s/veh	19.7	15.7	26.6	10.1	14.7	12.0
Incr Delay (d2), s/veh	10.1	0.2	6.8	3.0	5.6	0.6
Initial Q Delay(d3),s/veh	0.0	0.0	0.0	0.0	0.0	0.0
%ile BackOfQ(50%),veh/ln	6.2	0.0	1.0	6.9	7.2	2.5
Unsig. Movement Delay, s/veh						
LnGrp Delay(d),s/veh	29.7	15.9	33.4	13.0	20.3	12.5
LnGrp LOS	C	B	C	B	C	B
Approach Vol, veh/h	518			909	1021	
Approach Delay, s/veh	27.5			14.5	17.7	
Approach LOS	C			B	B	
Timer - Assigned Phs		2		4	5	6
Phs Duration (G+Y+Rc), s		36.9		20.7	7.7	29.2
Change Period (Y+Rc), s		4.5		4.5	4.5	4.5
Max Green Setting (Gmax), s		40.5		20.5	5.0	31.0
Max Q Clear Time (g_c+I1), s		22.8		15.3	4.0	20.7
Green Ext Time (p_c), s		5.9		0.9	0.0	4.0
<b>Intersection Summary</b>						
HCM 6th Ctrl Delay			18.6			
HCM 6th LOS			B			

HCM 6th Roundabout  
4: Old Redwood Hwy & Fulton Rd

08/02/2020

Intersection				
Intersection Delay, s/veh	33.6			
Intersection LOS	D			
Approach	EB	NB	SB	
Entry Lanes	1	1	2	
Conflicting Circle Lanes	1	1	1	
Adj Approach Flow, veh/h	518	909	1021	
Demand Flow Rate, veh/h	529	927	1042	
Vehicles Circulating, veh/h	693	443	64	
Vehicles Exiting, veh/h	413	779	1306	
Ped Vol Crossing Leg, #/h	0	0	0	
Ped Cap Adj	1.000	1.000	1.000	
Approach Delay, s/veh	25.5	67.9	7.1	
Approach LOS	D	F	A	
Lane	Left	Left	Left	Right
Designated Moves	LR	LT	LT	R
Assumed Moves	LR	LT	LT	R
RT Channelized				
Lane Util	1.000	1.000	0.665	0.335
Follow-Up Headway, s	2.609	2.609	2.535	2.535
Critical Headway, s	4.976	4.976	4.544	4.544
Entry Flow, veh/h	529	927	693	349
Cap Entry Lane, veh/h	681	878	1340	1340
Entry HV Adj Factor	0.979	0.981	0.980	0.980
Flow Entry, veh/h	518	909	679	342
Cap Entry, veh/h	666	861	1313	1313
V/C Ratio	0.777	1.056	0.517	0.260
Control Delay, s/veh	25.5	67.9	8.2	5.0
LOS	D	F	A	A
95th %tile Queue, veh	7	22	3	1



HCM 6th Signalized Intersection Summary  
 7: Old Redwood Hwy & Creekside Apts/Faught Rd

08/02/2020



Movement	EBL	EBT	EBR	WBL	WBT	WBR	NBL	NBT	NBR	SBL	SBT	SBR
Lane Configurations		↕			↕		↗	↖	↗	↗	↖	↖
Traffic Volume (veh/h)	20	20	30	101	20	60	30	929	172	50	1005	50
Future Volume (veh/h)	20	20	30	101	20	60	30	929	172	50	1005	50
Initial Q (Qb), veh	0	0	0	0	0	0	0	0	0	0	0	0
Ped-Bike Adj(A_pbT)	1.00		1.00	1.00		1.00	1.00		1.00	1.00		1.00
Parking Bus, Adj	1.00	1.00	1.00	1.00	1.00	1.00	1.00	1.00	1.00	1.00	1.00	1.00
Work Zone On Approach		No			No			No			No	
Adj Sat Flow, veh/h/ln	1870	1870	1870	1870	1870	1870	1870	1870	1870	1870	1870	1870
Adj Flow Rate, veh/h	21	21	32	106	21	63	32	978	181	53	1058	53
Peak Hour Factor	0.95	0.95	0.95	0.95	0.95	0.95	0.95	0.95	0.95	0.95	0.95	0.95
Percent Heavy Veh, %	2	2	2	2	2	2	2	2	2	2	2	2
Cap, veh/h	27	27	42	124	25	74	50	1146	971	69	1100	55
Arrive On Green	0.06	0.06	0.06	0.13	0.13	0.13	0.03	0.61	0.61	0.04	0.62	0.62
Sat Flow, veh/h	486	486	741	959	190	570	1781	1870	1585	1781	1766	88
Grp Volume(v), veh/h	74	0	0	190	0	0	32	978	181	53	0	1111
Grp Sat Flow(s),veh/h/ln	1713	0	0	1720	0	0	1781	1870	1585	1781	0	1854
Q Serve(g_s), s	4.7	0.0	0.0	11.9	0.0	0.0	2.0	46.8	5.5	3.2	0.0	62.1
Cycle Q Clear(g_c), s	4.7	0.0	0.0	11.9	0.0	0.0	2.0	46.8	5.5	3.2	0.0	62.1
Prop In Lane	0.28		0.43	0.56		0.33	1.00		1.00	1.00		0.05
Lane Grp Cap(c), veh/h	96	0	0	222	0	0	50	1146	971	69	0	1156
V/C Ratio(X)	0.77	0.00	0.00	0.86	0.00	0.00	0.63	0.85	0.19	0.77	0.00	0.96
Avail Cap(c_a), veh/h	284	0	0	281	0	0	234	1208	1024	234	0	1198
HCM Platoon Ratio	1.00	1.00	1.00	1.00	1.00	1.00	1.00	1.00	1.00	1.00	1.00	1.00
Upstream Filter(I)	1.00	0.00	0.00	1.00	0.00	0.00	1.00	1.00	1.00	1.00	0.00	1.00
Uniform Delay (d), s/veh	51.3	0.0	0.0	47.0	0.0	0.0	53.0	17.3	9.3	52.5	0.0	19.5
Incr Delay (d2), s/veh	12.0	0.0	0.0	18.5	0.0	0.0	12.4	5.9	0.1	16.4	0.0	17.3
Initial Q Delay(d3),s/veh	0.0	0.0	0.0	0.0	0.0	0.0	0.0	0.0	0.0	0.0	0.0	0.0
%ile BackOfQ(50%),veh/ln	2.3	0.0	0.0	6.2	0.0	0.0	1.0	19.8	1.8	1.8	0.0	28.9
Unsig. Movement Delay, s/veh												
LnGrp Delay(d),s/veh	63.3	0.0	0.0	65.5	0.0	0.0	65.4	23.2	9.4	68.9	0.0	36.8
LnGrp LOS	E	A	A	E	A	A	E	C	A	E	A	D
Approach Vol, veh/h		74			190			1191			1164	
Approach Delay, s/veh		63.3			65.5			22.2			38.3	
Approach LOS		E			E			C			D	
Timer - Assigned Phs		2	3	4		6	7	8				
Phs Duration (G+Y+Rc), s		10.7	8.8	72.1		18.7	7.6	73.2				
Change Period (Y+Rc), s		4.5	4.5	4.5		4.5	4.5	4.5				
Max Green Setting (Gmax), s		18.3	14.5	71.2		18.0	14.5	71.2				
Max Q Clear Time (g_c+I1), s		6.7	5.2	48.8		13.9	4.0	64.1				
Green Ext Time (p_c), s		0.2	0.1	8.9		0.3	0.0	4.6				
<b>Intersection Summary</b>												
HCM 6th Ctrl Delay				33.7								
HCM 6th LOS				C								

# HCM 6th Signalized Intersection Summary

## 8: Old Redwood Hwy & Mark West Commons Cir/Wikiup Dr

08/02/2020



Movement	EBL	EBT	EBR	WBL	WBT	WBR	NBL	NBT	NBR	SBL	SBT	SBR
Lane Configurations		↕			↕	↕	↕	↑	↕	↕	↑	↕
Traffic Volume (veh/h)	20	20	20	199	20	158	40	894	216	115	921	20
Future Volume (veh/h)	20	20	20	199	20	158	40	894	216	115	921	20
Initial Q (Qb), veh	0	0	0	0	0	0	0	0	0	0	0	0
Ped-Bike Adj(A_pbT)	1.00		0.99	1.00		0.99	1.00		1.00	1.00		1.00
Parking Bus, Adj	1.00	1.00	1.00	1.00	1.00	1.00	1.00	1.00	1.00	1.00	1.00	1.00
Work Zone On Approach		No			No			No			No	
Adj Sat Flow, veh/h/ln	1870	1870	1870	1870	1870	1870	1870	1870	1870	1870	1870	1870
Adj Flow Rate, veh/h	21	21	21	209	21	166	42	941	227	121	969	21
Peak Hour Factor	0.95	0.95	0.95	0.95	0.95	0.95	0.95	0.95	0.95	0.95	0.95	0.95
Percent Heavy Veh, %	2	2	2	2	2	2	2	2	2	2	2	2
Cap, veh/h	42	41	20	225	17	417	54	978	825	147	1076	908
Arrive On Green	0.27	0.27	0.27	0.27	0.27	0.27	0.03	0.52	0.52	0.08	0.58	0.58
Sat Flow, veh/h	0	154	77	620	62	1570	1781	1870	1577	1781	1870	1578
Grp Volume(v), veh/h	63	0	0	230	0	166	42	941	227	121	969	21
Grp Sat Flow(s),veh/h/ln	231	0	0	683	0	1570	1781	1870	1577	1781	1870	1578
Q Serve(g_s), s	0.0	0.0	0.0	0.0	0.0	9.9	2.7	55.3	9.2	7.7	52.3	0.7
Cycle Q Clear(g_c), s	30.4	0.0	0.0	30.4	0.0	9.9	2.7	55.3	9.2	7.7	52.3	0.7
Prop In Lane	0.33		0.33	0.91		1.00	1.00		1.00	1.00		1.00
Lane Grp Cap(c), veh/h	103	0	0	241	0	417	54	978	825	147	1076	908
V/C Ratio(X)	0.61	0.00	0.00	0.95	0.00	0.40	0.78	0.96	0.28	0.82	0.90	0.02
Avail Cap(c_a), veh/h	103	0	0	241	0	417	62	1060	894	154	1156	976
HCM Platoon Ratio	1.00	1.00	1.00	1.00	1.00	1.00	1.00	1.00	1.00	1.00	1.00	1.00
Upstream Filter(I)	1.00	0.00	0.00	1.00	0.00	1.00	1.00	1.00	1.00	1.00	1.00	1.00
Uniform Delay (d), s/veh	35.1	0.0	0.0	45.3	0.0	34.5	55.2	26.2	15.2	51.7	21.4	10.5
Incr Delay (d2), s/veh	7.4	0.0	0.0	44.7	0.0	0.2	35.6	18.1	0.1	26.0	8.9	0.0
Initial Q Delay(d3),s/veh	0.0	0.0	0.0	0.0	0.0	0.0	0.0	0.0	0.0	0.0	0.0	0.0
%ile BackOfQ(50%),veh/ln	1.6	0.0	0.0	9.7	0.0	3.8	1.7	27.8	3.2	4.4	23.6	0.2
Unsig. Movement Delay, s/veh												
LnGrp Delay(d),s/veh	42.5	0.0	0.0	90.0	0.0	34.8	90.7	44.3	15.3	77.7	30.3	10.5
LnGrp LOS	D	A	A	F	A	C	F	D	B	E	C	B
Approach Vol, veh/h		63			396			1210			1111	
Approach Delay, s/veh		42.5			66.8			40.5			35.1	
Approach LOS		D			E			D			D	
Timer - Assigned Phs		2	3	4		6	7	8				
Phs Duration (G+Y+Rc), s		35.0	8.6	71.0		35.0	14.6	65.0				
Change Period (Y+Rc), s		4.6	5.1	5.1		4.6	5.1	5.1				
Max Green Setting (Gmax), s		30.4	4.0	70.8		30.4	9.9	64.9				
Max Q Clear Time (g_c+I1), s		32.4	4.7	54.3		32.4	9.7	57.3				
Green Ext Time (p_c), s		0.0	0.0	3.5		0.0	0.0	2.5				

### Intersection Summary

HCM 6th Ctrl Delay	42.1
HCM 6th LOS	D

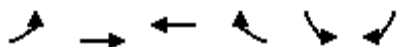
### Notes

User approved pedestrian interval to be less than phase max green.

# HCM 6th Signalized Intersection Summary

## 9: Pocket Canyon Hwy/Front St & Mirabel Rd

08/02/2020



Movement	EBL	EBT	WBT	WBR	SBL	SBR
Lane Configurations		↕	↕	↕	↕	↕
Traffic Volume (veh/h)	52	285	299	653	413	80
Future Volume (veh/h)	52	285	299	653	413	80
Initial Q (Qb), veh	0	0	0	0	0	0
Ped-Bike Adj(A_pbT)	1.00			1.00	1.00	1.00
Parking Bus, Adj	1.00	1.00	1.00	1.00	1.00	1.00
Work Zone On Approach		No	No		No	
Adj Sat Flow, veh/h/ln	1870	1870	1870	1870	1870	1870
Adj Flow Rate, veh/h	55	300	315	687	435	84
Peak Hour Factor	0.95	0.95	0.95	0.95	0.95	0.95
Percent Heavy Veh, %	2	2	2	2	2	2
Cap, veh/h	154	733	951	806	534	475
Arrive On Green	0.51	0.51	0.51	0.51	0.30	0.30
Sat Flow, veh/h	129	1443	1870	1585	1781	1585
Grp Volume(v), veh/h	355	0	315	687	435	84
Grp Sat Flow(s),veh/h/ln	1571	0	1870	1585	1781	1585
Q Serve(g_s), s	0.0	0.0	4.7	17.6	10.6	1.8
Cycle Q Clear(g_c), s	5.4	0.0	4.7	17.6	10.6	1.8
Prop In Lane	0.15			1.00	1.00	1.00
Lane Grp Cap(c), veh/h	888	0	951	806	534	475
V/C Ratio(X)	0.40	0.00	0.33	0.85	0.82	0.18
Avail Cap(c_a), veh/h	1142	0	1297	1100	1084	964
HCM Platoon Ratio	1.00	1.00	1.00	1.00	1.00	1.00
Upstream Filter(I)	1.00	0.00	1.00	1.00	1.00	1.00
Uniform Delay (d), s/veh	7.0	0.0	6.8	10.0	15.2	12.1
Incr Delay (d2), s/veh	0.3	0.0	0.2	4.9	3.1	0.2
Initial Q Delay(d3),s/veh	0.0	0.0	0.0	0.0	0.0	0.0
%ile BackOfQ(50%),veh/ln	1.3	0.0	1.5	5.6	3.6	0.5
Unsig. Movement Delay, s/veh						
LnGrp Delay(d),s/veh	7.3	0.0	7.0	14.9	18.3	12.3
LnGrp LOS	A	A	A	B	B	B
Approach Vol, veh/h		355	1002		519	
Approach Delay, s/veh		7.3	12.4		17.3	
Approach LOS		A	B		B	
Timer - Assigned Phs				4	6	8
Phs Duration (G+Y+Rc), s				28.3	18.5	28.3
Change Period (Y+Rc), s				4.5	4.5	4.5
Max Green Setting (Gmax), s				32.5	28.5	32.5
Max Q Clear Time (g_c+I1), s				7.4	12.6	19.6
Green Ext Time (p_c), s				2.4	1.4	4.2
<b>Intersection Summary</b>						
HCM 6th Ctrl Delay			12.8			
HCM 6th LOS			B			

HCM 6th Roundabout  
 9: Pocket Canyon Hwy/Front St & Mirabel Rd

08/02/2020

Intersection			
Intersection Delay, s/veh	13.2		
Intersection LOS	B		
Approach	EB	WB	SB
Entry Lanes	1	1	1
Conflicting Circle Lanes	1	1	1
Adj Approach Flow, veh/h	355	1002	519
Demand Flow Rate, veh/h	362	1022	530
Vehicles Circulating, veh/h	444	56	321
Vehicles Exiting, veh/h	407	750	757
Ped Vol Crossing Leg, #/h	0	0	0
Ped Cap Adj	1.000	1.000	1.000
Approach Delay, s/veh	9.2	16.1	10.5
Approach LOS	A	C	B
Lane	Left	Left	Left
Designated Moves	LT	TR	LR
Assumed Moves	LT	TR	LR
RT Channelized			
Lane Util	1.000	1.000	1.000
Follow-Up Headway, s	2.609	2.609	2.609
Critical Headway, s	4.976	4.976	4.976
Entry Flow, veh/h	362	1022	530
Cap Entry Lane, veh/h	877	1303	995
Entry HV Adj Factor	0.981	0.980	0.979
Flow Entry, veh/h	355	1002	519
Cap Entry, veh/h	860	1277	974
V/C Ratio	0.413	0.784	0.533
Control Delay, s/veh	9.2	16.1	10.5
LOS	A	C	B
95th %tile Queue, veh	2	9	3

# HCM 6th Signalized Intersection Summary

## 11: Private Dwy/Moorland Ave & Todd Rd

08/02/2020



Movement	EBL	EBT	EBR	WBL	WBT	WBR	NBL	NBT	NBR	SBL	SBT	SBR
Lane Configurations												
Traffic Volume (veh/h)	72	748	20	30	625	490	20	30	30	505	30	42
Future Volume (veh/h)	72	748	20	30	625	490	20	30	30	505	30	42
Initial Q (Qb), veh	0	0	0	0	0	0	0	0	0	0	0	0
Ped-Bike Adj(A_pbT)	1.00		1.00	1.00		1.00	1.00		1.00	1.00		1.00
Parking Bus, Adj	1.00	1.00	1.00	1.00	1.00	1.00	1.00	1.00	1.00	1.00	1.00	1.00
Work Zone On Approach		No			No			No			No	
Adj Sat Flow, veh/h/ln	1870	1870	1870	1870	1870	1870	1870	1870	1870	1870	1870	1870
Adj Flow Rate, veh/h	76	787	21	32	658	516	21	32	32	532	32	44
Peak Hour Factor	0.95	0.95	0.95	0.95	0.95	0.95	0.95	0.95	0.95	0.95	0.95	0.95
Percent Heavy Veh, %	2	2	2	2	2	2	2	2	2	2	2	2
Cap, veh/h	89	852	23	47	834	707	26	40	40	513	31	482
Arrive On Green	0.05	0.47	0.47	0.03	0.45	0.45	0.06	0.06	0.06	0.30	0.30	0.30
Sat Flow, veh/h	1781	1813	48	1781	1870	1585	428	652	652	1685	101	1585
Grp Volume(v), veh/h	76	0	808	32	658	516	85	0	0	564	0	44
Grp Sat Flow(s),veh/h/ln	1781	0	1862	1781	1870	1585	1732	0	0	1786	0	1585
Q Serve(g_s), s	5.5	0.0	52.8	2.3	39.0	34.7	6.3	0.0	0.0	39.5	0.0	2.6
Cycle Q Clear(g_c), s	5.5	0.0	52.8	2.3	39.0	34.7	6.3	0.0	0.0	39.5	0.0	2.6
Prop In Lane	1.00		0.03	1.00		1.00	0.25		0.38	0.94		1.00
Lane Grp Cap(c), veh/h	89	0	875	47	834	707	106	0	0	543	0	482
V/C Ratio(X)	0.85	0.00	0.92	0.68	0.79	0.73	0.81	0.00	0.00	1.04	0.00	0.09
Avail Cap(c_a), veh/h	89	0	1131	70	1116	946	113	0	0	543	0	482
HCM Platoon Ratio	1.00	1.00	1.00	1.00	1.00	1.00	1.00	1.00	1.00	1.00	1.00	1.00
Upstream Filter(I)	1.00	0.00	1.00	1.00	1.00	1.00	1.00	0.00	0.00	1.00	0.00	1.00
Uniform Delay (d), s/veh	61.2	0.0	32.2	62.7	30.7	29.5	60.2	0.0	0.0	45.2	0.0	32.3
Incr Delay (d2), s/veh	50.8	0.0	10.5	15.9	2.8	1.9	31.5	0.0	0.0	48.8	0.0	0.1
Initial Q Delay(d3),s/veh	0.0	0.0	0.0	0.0	0.0	0.0	0.0	0.0	0.0	0.0	0.0	0.0
%ile BackOfQ(50%),veh/ln	3.7	0.0	25.4	1.3	17.8	13.3	3.7	0.0	0.0	24.7	0.0	1.0
Unsig. Movement Delay, s/veh												
LnGrp Delay(d),s/veh	111.9	0.0	42.8	78.6	33.5	31.5	91.8	0.0	0.0	94.0	0.0	32.4
LnGrp LOS	F	A	D	E	C	C	F	A	A	F	A	C
Approach Vol, veh/h		884			1206			85			608	
Approach Delay, s/veh		48.7			33.8			91.8			89.5	
Approach LOS		D			C			F			F	
Timer - Assigned Phs		2	3	4		6	7	8				
Phs Duration (G+Y+Rc), s		12.4	7.9	65.5		44.0	11.0	62.4				
Change Period (Y+Rc), s		4.5	4.5	4.5		4.5	4.5	4.5				
Max Green Setting (Gmax), s		8.5	5.1	78.9		39.5	6.5	77.5				
Max Q Clear Time (g_c+I1), s		8.3	4.3	54.8		41.5	7.5	41.0				
Green Ext Time (p_c), s		0.0	0.0	6.2		0.0	0.0	7.5				
<b>Intersection Summary</b>												
HCM 6th Ctrl Delay			52.5									
HCM 6th LOS			D									

# HCM 6th Signalized Intersection Summary

## 12: S Moreland Ave & Todd Rd

08/02/2020



Movement	EBL	EBT	EBR	WBL	WBT	WBR	NBL	NBT	NBR	SBL	SBT	SBR
Lane Configurations		↕	↗	↖	↘	↙	↖	↕	↗		↕	
Traffic Volume (veh/h)	0	585	698	460	413	0	732	0	197	0	0	0
Future Volume (veh/h)	0	585	698	460	413	0	732	0	197	0	0	0
Initial Q (Qb), veh	0	0	0	0	0	0	0	0	0	0	0	0
Ped-Bike Adj(A_pbT)	1.00		1.00	1.00		1.00	1.00		1.00	1.00		1.00
Parking Bus, Adj	1.00	1.00	1.00	1.00	1.00	1.00	1.00	1.00	1.00	1.00	1.00	1.00
Work Zone On Approach		No		No		No		No		No		No
Adj Sat Flow, veh/h/ln	984	1870	1870	1870	1870	1870	1870	1870	1870	1870	1870	1870
Adj Flow Rate, veh/h	0	616	735	484	435	0	771	0	207	0	0	0
Peak Hour Factor	0.95	0.95	0.95	0.95	0.95	0.95	0.95	0.95	0.95	0.95	0.95	0.95
Percent Heavy Veh, %	2	2	2	2	2	2	2	2	2	2	2	2
Cap, veh/h	0	693	975	526	552	0	872	0	388	0	2	0
Arrive On Green	0.00	0.37	0.37	0.30	0.30	0.00	0.24	0.00	0.24	0.00	0.00	0.00
Sat Flow, veh/h	0	1870	1585	1781	1870	0	3563	0	1585	0	1870	0
Grp Volume(v), veh/h	0	616	735	484	435	0	771	0	207	0	0	0
Grp Sat Flow(s),veh/h/ln	0	1870	1585	1781	1870	0	1781	0	1585	0	1870	0
Q Serve(g_s), s	0.0	31.7	34.2	27.0	21.9	0.0	21.4	0.0	11.6	0.0	0.0	0.0
Cycle Q Clear(g_c), s	0.0	31.7	34.2	27.0	21.9	0.0	21.4	0.0	11.6	0.0	0.0	0.0
Prop In Lane	0.00		1.00	1.00		0.00	1.00		1.00	0.00		0.00
Lane Grp Cap(c), veh/h	0	693	975	526	552	0	872	0	388	0	2	0
V/C Ratio(X)	0.00	0.89	0.75	0.92	0.79	0.00	0.88	0.00	0.53	0.00	0.00	0.00
Avail Cap(c_a), veh/h	0	711	990	555	583	0	965	0	429	0	73	0
HCM Platoon Ratio	1.00	1.00	1.00	1.00	1.00	1.00	1.00	1.00	1.00	1.00	1.00	1.00
Upstream Filter(I)	0.00	1.00	1.00	1.00	1.00	0.00	1.00	0.00	1.00	0.00	0.00	0.00
Uniform Delay (d), s/veh	0.0	30.3	14.2	35.0	33.2	0.0	37.4	0.0	33.7	0.0	0.0	0.0
Incr Delay (d2), s/veh	0.0	13.1	3.3	20.2	6.8	0.0	9.2	0.0	1.1	0.0	0.0	0.0
Initial Q Delay(d3),s/veh	0.0	0.0	0.0	0.0	0.0	0.0	0.0	0.0	0.0	0.0	0.0	0.0
%ile BackOfQ(50%),veh/ln	0.0	16.2	19.5	14.2	10.7	0.0	10.3	0.0	4.6	0.0	0.0	0.0
Unsig. Movement Delay, s/veh												
LnGrp Delay(d),s/veh	0.0	43.4	17.5	55.2	40.0	0.0	46.6	0.0	34.8	0.0	0.0	0.0
LnGrp LOS	A	D	B	E	D	A	D	A	C	A	A	A
Approach Vol, veh/h		1351		919		978		0				
Approach Delay, s/veh		29.3		48.0		44.1		0.0				
Approach LOS		C		D		D						
Timer - Assigned Phs		2		4		6		8				
Phs Duration (G+Y+Rc), s		0.0		41.2		28.1		33.3				
Change Period (Y+Rc), s		3.0		3.2		3.0		3.0				
Max Green Setting (Gmax), s		4.0		39.0		27.8		32.0				
Max Q Clear Time (g_c+I1), s		0.0		36.2		23.4		29.0				
Green Ext Time (p_c), s		0.0		1.9		1.7		1.3				

### Intersection Summary

HCM 6th Ctrl Delay	39.0
HCM 6th LOS	D

### Notes

- User approved pedestrian interval to be less than phase max green.
- User approved volume balancing among the lanes for turning movement.

HCM 6th Roundabout  
16: Riverside Dr & Verano Ave

08/02/2020

Intersection				
Intersection Delay, s/veh	10.2			
Intersection LOS	B			
Approach	EB	WB	NB	SB
Entry Lanes	1	1	1	1
Conflicting Circle Lanes	1	1	1	1
Adj Approach Flow, veh/h	589	689	159	199
Demand Flow Rate, veh/h	601	703	163	203
Vehicles Circulating, veh/h	241	199	552	565
Vehicles Exiting, veh/h	527	516	290	337
Ped Vol Crossing Leg, #/h	0	0	0	0
Ped Cap Adj	1.000	1.000	1.000	1.000
Approach Delay, s/veh	10.4	11.6	7.0	7.7
Approach LOS	B	B	A	A
Lane	Left	Left	Left	Left
Designated Moves	LTR	LTR	LTR	LTR
Assumed Moves	LTR	LTR	LTR	LTR
RT Channelized				
Lane Util	1.000	1.000	1.000	1.000
Follow-Up Headway, s	2.609	2.609	2.609	2.609
Critical Headway, s	4.976	4.976	4.976	4.976
Entry Flow, veh/h	601	703	163	203
Cap Entry Lane, veh/h	1079	1126	786	775
Entry HV Adj Factor	0.981	0.980	0.976	0.979
Flow Entry, veh/h	589	689	159	199
Cap Entry, veh/h	1058	1104	767	759
V/C Ratio	0.557	0.624	0.207	0.262
Control Delay, s/veh	10.4	11.6	7.0	7.7
LOS	B	B	A	A
95th %tile Queue, veh	4	5	1	1

# HCM 6th Signalized Intersection Summary

## 18: Old Redwood Hwy & Main St

08/02/2020



Movement	WBL	WBR	NBT	NBR	SBL	SBT
Lane Configurations						
Traffic Volume (veh/h)	453	32	725	922	32	340
Future Volume (veh/h)	453	32	725	922	32	340
Initial Q (Qb), veh	0	0	0	0	0	0
Ped-Bike Adj(A_pbT)	1.00	1.00		1.00	1.00	
Parking Bus, Adj	1.00	1.00	1.00	1.00	1.00	1.00
Work Zone On Approach	No		No		No	
Adj Sat Flow, veh/h/ln	1870	1870	1870	1870	1870	1870
Adj Flow Rate, veh/h	477	34	763	971	34	358
Peak Hour Factor	0.95	0.95	0.95	0.95	0.95	0.95
Percent Heavy Veh, %	2	2	2	2	2	2
Cap, veh/h	456	405	1079	915	43	1222
Arrive On Green	0.26	0.26	0.58	0.58	0.02	0.65
Sat Flow, veh/h	1781	1585	1870	1585	1781	1870
Grp Volume(v), veh/h	477	34	763	971	34	358
Grp Sat Flow(s),veh/h/ln	1781	1585	1870	1585	1781	1870
Q Serve(g_s), s	30.4	1.9	34.6	68.6	2.3	9.8
Cycle Q Clear(g_c), s	30.4	1.9	34.6	68.6	2.3	9.8
Prop In Lane	1.00	1.00		1.00	1.00	
Lane Grp Cap(c), veh/h	456	405	1079	915	43	1222
V/C Ratio(X)	1.05	0.08	0.71	1.06	0.79	0.29
Avail Cap(c_a), veh/h	456	405	1079	915	60	1240
HCM Platoon Ratio	1.00	1.00	1.00	1.00	1.00	1.00
Upstream Filter(I)	1.00	1.00	1.00	1.00	1.00	1.00
Uniform Delay (d), s/veh	44.2	33.6	18.0	25.1	57.7	8.8
Incr Delay (d2), s/veh	55.0	0.0	1.8	47.5	25.3	0.0
Initial Q Delay(d3),s/veh	0.0	0.0	0.0	0.0	0.0	0.0
%ile BackOfQ(50%),veh/ln	20.4	0.8	14.2	35.1	1.3	3.6
Unsig. Movement Delay, s/veh						
LnGrp Delay(d),s/veh	99.3	33.7	19.8	72.6	83.0	8.9
LnGrp LOS	F	C	B	F	F	A
Approach Vol, veh/h	511		1734			392
Approach Delay, s/veh	94.9		49.4			15.3
Approach LOS	F		D			B
Timer - Assigned Phs	1	2		4		6
Phs Duration (G+Y+Rc), s	9.1	74.8		35.0		83.9
Change Period (Y+Rc), s	6.2	6.2		4.6		6.2
Max Green Setting (Gmax), s	4.0	68.6		30.4		78.8
Max Q Clear Time (g_c+1), s	11.3	70.6		32.4		11.8
Green Ext Time (p_c), s	0.0	0.0		0.0		0.6

### Intersection Summary

HCM 6th Ctrl Delay	53.1
HCM 6th LOS	D

### Notes

User approved pedestrian interval to be less than phase max green.



**ATTACHMENT D**  
**VOLUME FIGURES**





Major Street **Old Redwood Highway**  
 Minor Street **Fulton Road**

Project **Sonoma County Housing Rezone**  
 Scenario **Existing Conditions**  
 Peak Hour **PM Peak Hour**

Turn Movement Volumes

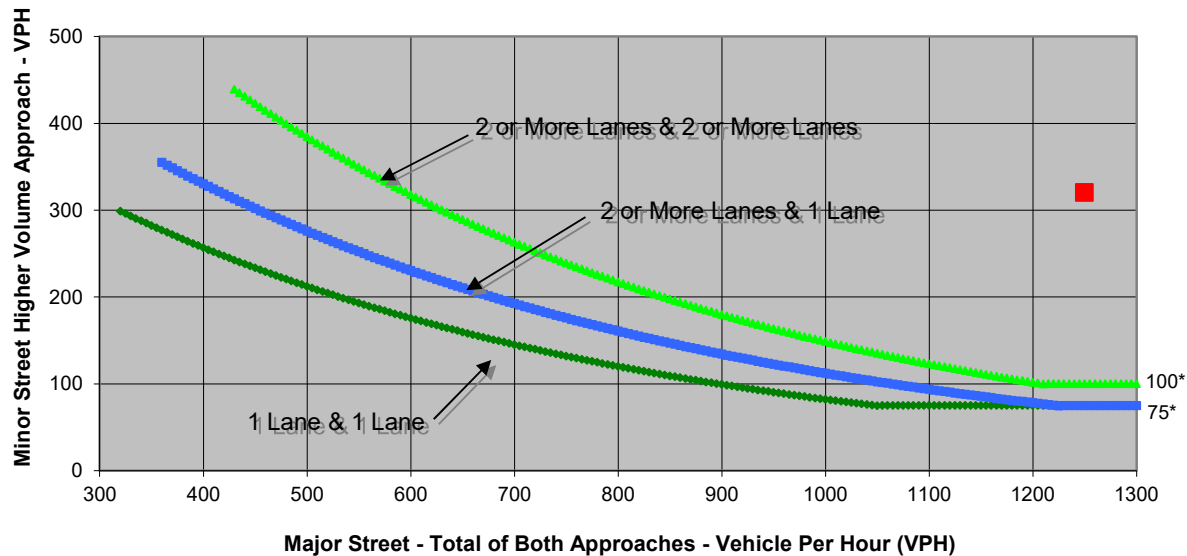
	NB	SB	EB	WB
Left	40	0	270	0
Through	550	440	0	0
Right	0	220	50	0
Total	590	660	320	0

Major Street Direction

x	North/South
	East/West

**Figure 4C-4. Warrant 3B, Peak Hour (70% Factor)**  
 (COMMUNITY LESS THAN 10,000 POPULATION OR

ABOVE 40 MPH ON MAJOR STREET



\* Note: 100 vph applies as the lower threshold volume for a minor-street approach with two or more lanes and 75 vph applies as the lower threshold volume for a minor-street approach with one lane.

Source: California Manual on Uniform Traffic Control Devices, Caltrans, 2014

	Major Street	Minor Street	Warrant Met
	Old Redwood Highway	Fulton Road	
<b>Number of Approach Lanes</b>	<b>1</b>	<b>2</b>	<b><u>YES</u></b>
<b>Traffic Volume (VPH) *</b>	<b>1,250</b>	<b>320</b>	

\* Note: Traffic Volume for Major Street is Total Volume of Both Approaches.  
 Traffic Volume for Minor Street is the Volume of High Volume Approach.

Major Street **Old Redwood Highway**  
 Minor Street **Fulton Road**

Project **Sonoma County Housing Rezone**  
 Scenario **Cumulative Conditions**  
 Peak Hour **AM Peak Hour**

Turn Movement Volumes

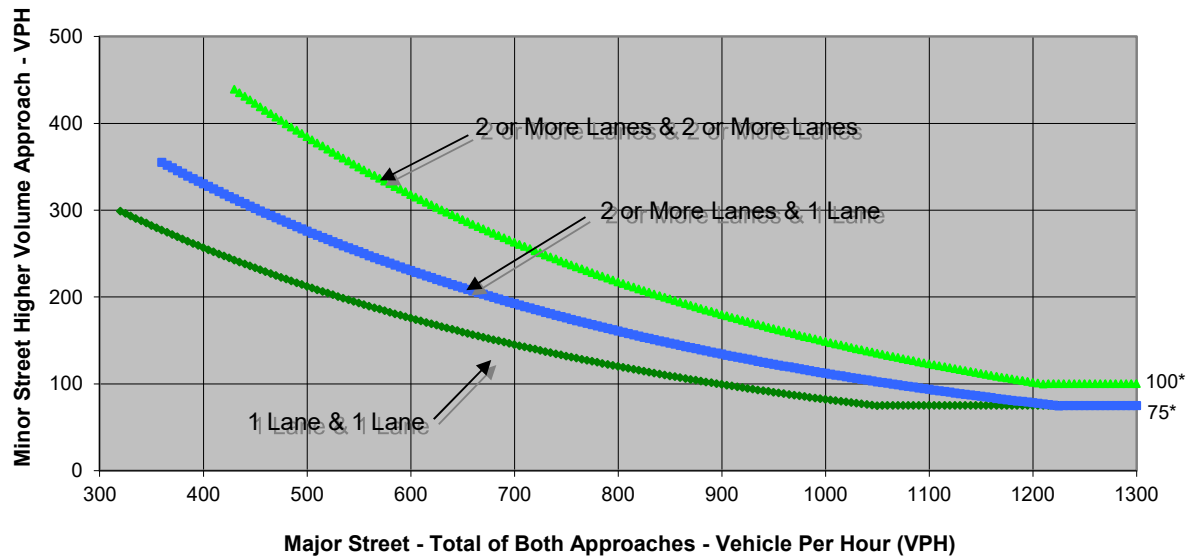
	NB	SB	EB	WB
Left	40	0	180	0
Through	190	860	0	0
Right	0	400	40	0
Total	230	1,260	220	0

Major Street Direction

x	North/South
	East/West

**Figure 4C-4. Warrant 3B, Peak Hour (70% Factor)**  
 (COMMUNITY LESS THAN 10,000 POPULATION OR

ABOVE 40 MPH ON MAJOR STREET



\* Note: 100 vph applies as the lower threshold volume for a minor-street approach with two or more lanes and 75 vph applies as the lower threshold volume for a minor-street approach with one lane.

Source: California Manual on Uniform Traffic Control Devices, Caltrans, 2014

	Major Street	Minor Street	Warrant Met
	Old Redwood Highway	Fulton Road	
<b>Number of Approach Lanes</b>	<b>2</b>	<b>2</b>	<b><u>YES</u></b>
<b>Traffic Volume (VPH) *</b>	<b>1,490</b>	<b>220</b>	

\* Note: Traffic Volume for Major Street is Total Volume of Both Approaches.  
 Traffic Volume for Minor Street is the Volume of High Volume Approach.

Major Street **Old Redwood Highway**  
 Minor Street **Fulton Road**

Project **Sonoma County Housing Rezone**  
 Scenario **Cumulative Conditions**  
 Peak Hour **PM Peak Hour**

Turn Movement Volumes

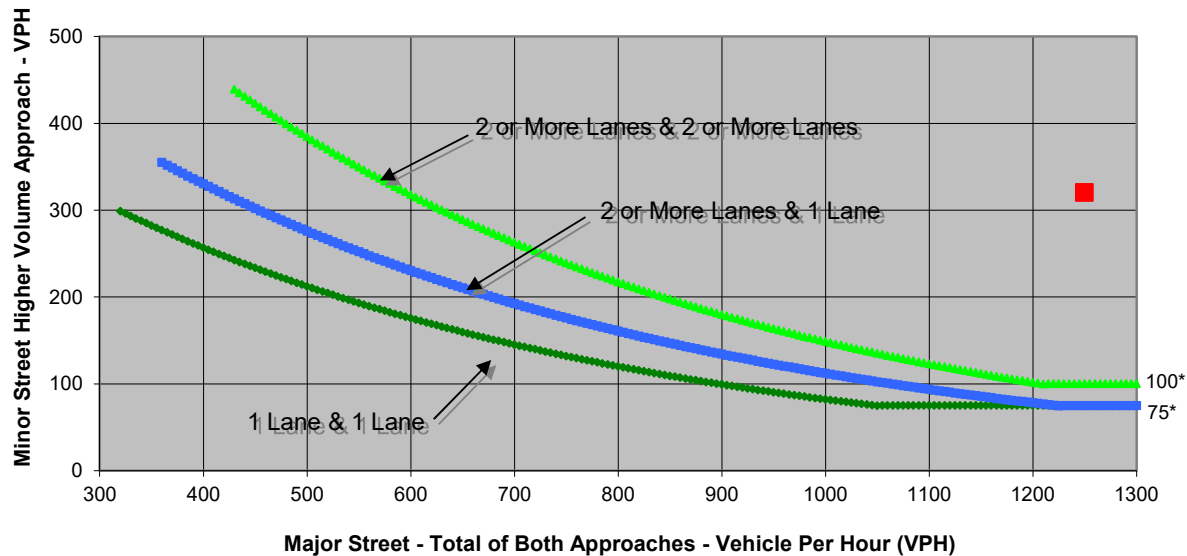
	NB	SB	EB	WB
Left	40	0	270	0
Through	550	440	0	0
Right	0	220	50	0
Total	590	660	320	0

Major Street Direction

x	North/South
	East/West

**Figure 4C-4. Warrant 3B, Peak Hour (70% Factor)**  
 (COMMUNITY LESS THAN 10,000 POPULATION OR

ABOVE 40 MPH ON MAJOR STREET



\* Note: 100 vph applies as the lower threshold volume for a minor-street approach with two or more lanes and 75 vph applies as the lower threshold volume for a minor-street approach with one lane.

Source: California Manual on Uniform Traffic Control Devices, Caltrans, 2014

	Major Street	Minor Street	Warrant Met
	Old Redwood Highway	Fulton Road	
<b>Number of Approach Lanes</b>	<b>1</b>	<b>2</b>	<b><u>YES</u></b>
<b>Traffic Volume (VPH) *</b>	<b>1,250</b>	<b>320</b>	

\* Note: Traffic Volume for Major Street is Total Volume of Both Approaches.  
 Traffic Volume for Minor Street is the Volume of High Volume Approach.



Major Street Old Redwood Highway  
 Minor Street Faught Road

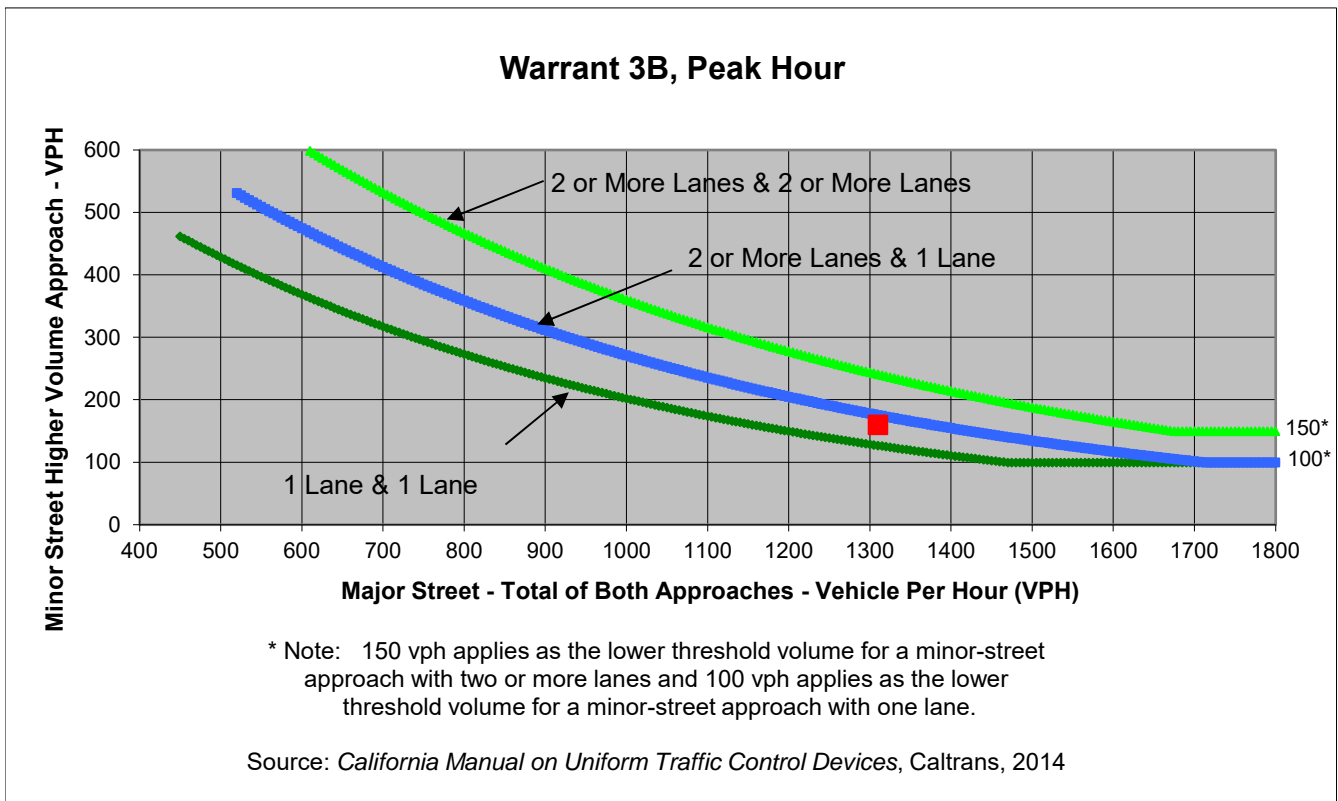
Project Sonoma County Housing Rezone  
 Scenario Existing Conditions  
 Peak Hour AM Peak Hour

Turn Movement Volumes

	NB	SB	EB	WB
Left	10	20	40	140
Through	330	850	10	10
Right	80	20	20	10
Total	420	890	70	160

Major Street Direction

x	North/South
	East/West



	Major Street	Minor Street	Warrant Met
	Old Redwood Highway	Faught Road	
<b>Number of Approach Lanes</b>	<b>2</b>	<b>1</b>	<b><u>NO</u></b>
<b>Traffic Volume (VPH) *</b>	<b>1,310</b>	<b>160</b>	

\* Note: Traffic Volume for Major Street is Total Volume of Both Approaches.  
 Traffic Volume for Minor Street is the Volume of High Volume Approach.



Major Street Old Redwood Highway  
 Minor Street Faught Road

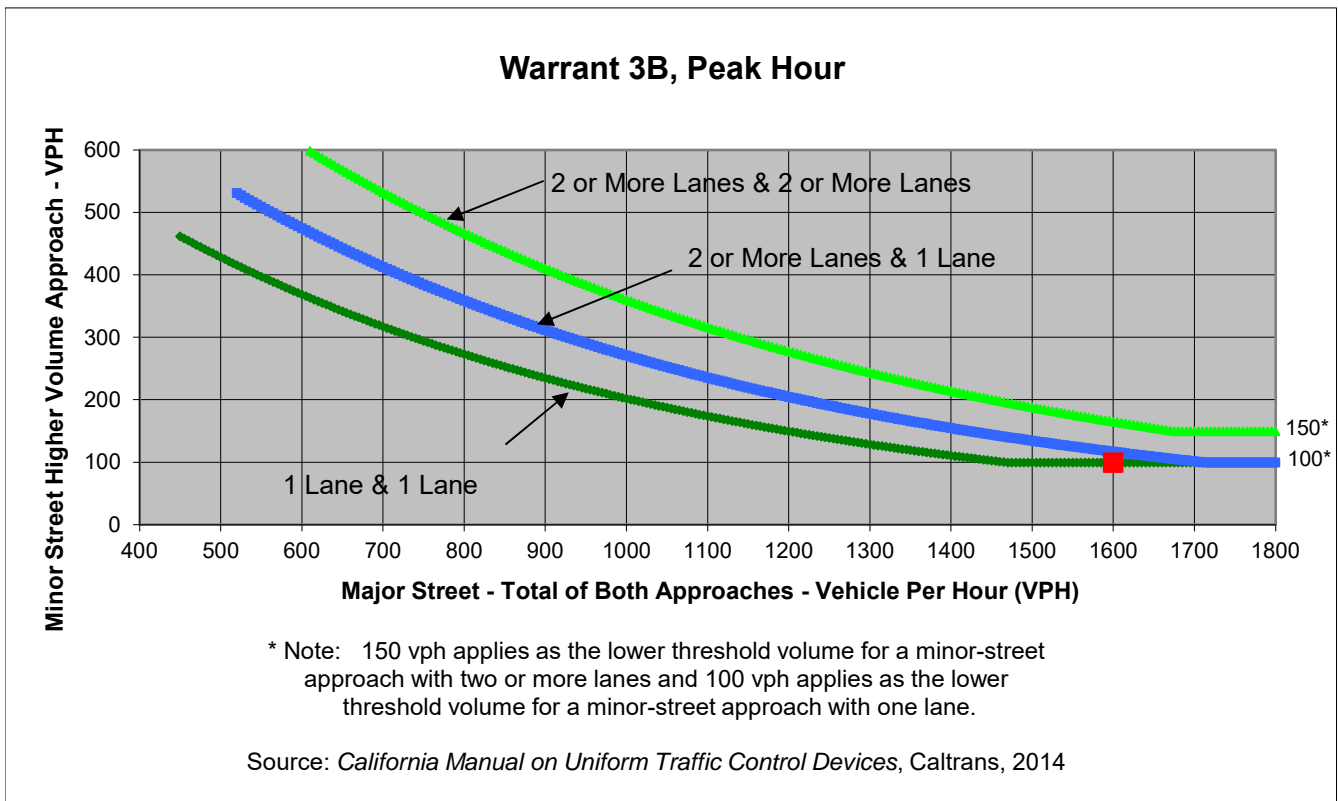
Project Sonoma County Housing Rezone  
 Scenario Existing Conditions  
 Peak Hour PM Peak Hour

Turn Movement Volumes

	NB	SB	EB	WB
Left	20	30	10	70
Through	700	700	10	10
Right	120	30	20	20
Total	840	760	40	100

Major Street Direction

x	North/South
	East/West



	Major Street	Minor Street	Warrant Met
	Old Redwood Highway	Faught Road	
<b>Number of Approach Lanes</b>	<b>2</b>	<b>1</b>	<b><u>NO</u></b>
<b>Traffic Volume (VPH) *</b>	<b>1,600</b>	<b>100</b>	

\* Note: Traffic Volume for Major Street is Total Volume of Both Approaches.  
 Traffic Volume for Minor Street is the Volume of High Volume Approach.



Major Street Old Redwood Highway  
 Minor Street Faught Road

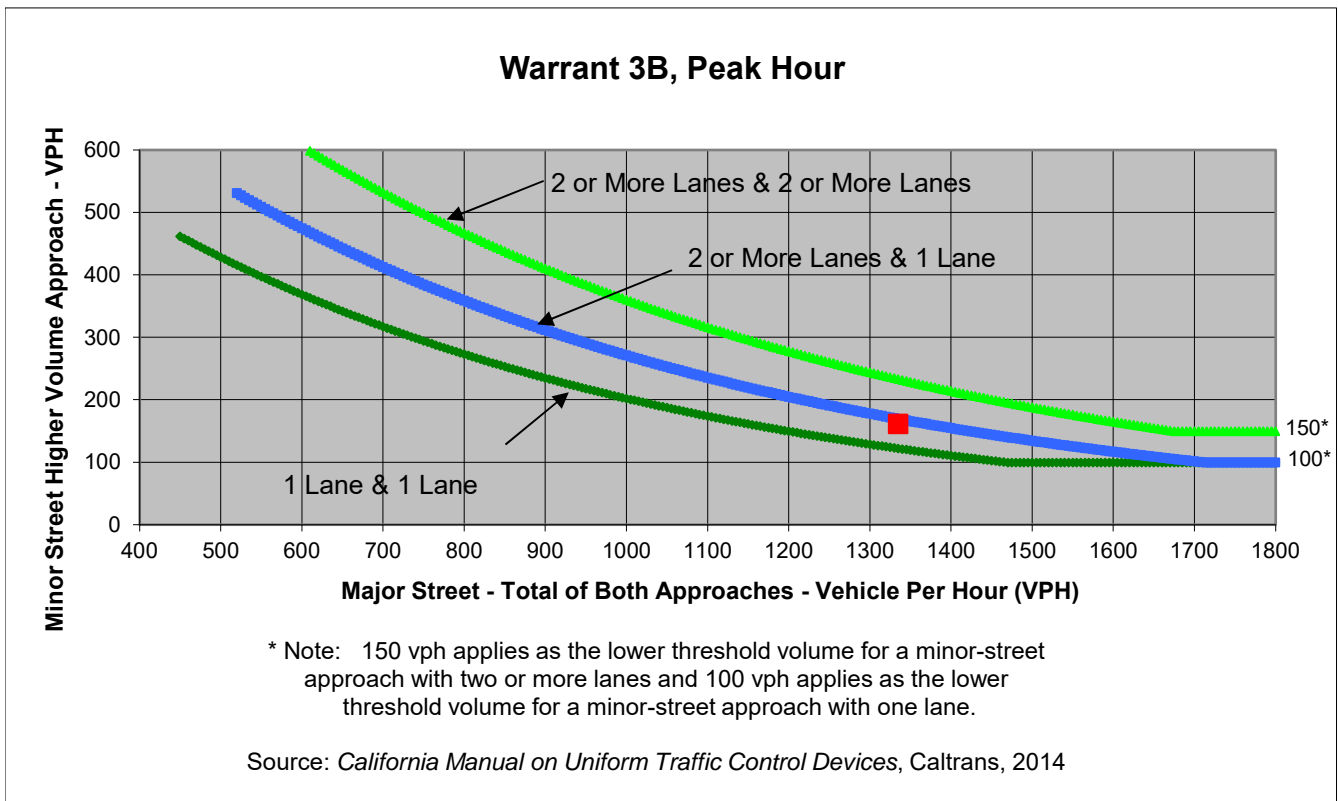
Project Sonoma County Housing Rezone  
 Scenario Existing + Program Conditions  
 Peak Hour AM Peak Hour

Turn Movement Volumes

	NB	SB	EB	WB
Left	10	20	40	142
Through	347	858	10	10
Right	80	20	20	10
Total	437	898	70	162

Major Street Direction

x	North/South
	East/West



	Major Street	Minor Street	Warrant Met
	Old Redwood Highway	Faught Road	
Number of Approach Lanes	2	1	<b>NO</b>
Traffic Volume (VPH) *	1,335	162	

\* Note: Traffic Volume for Major Street is Total Volume of Both Approaches.  
 Traffic Volume for Minor Street is the Volume of High Volume Approach.



Major Street Old Redwood Highway  
 Minor Street Faught Road

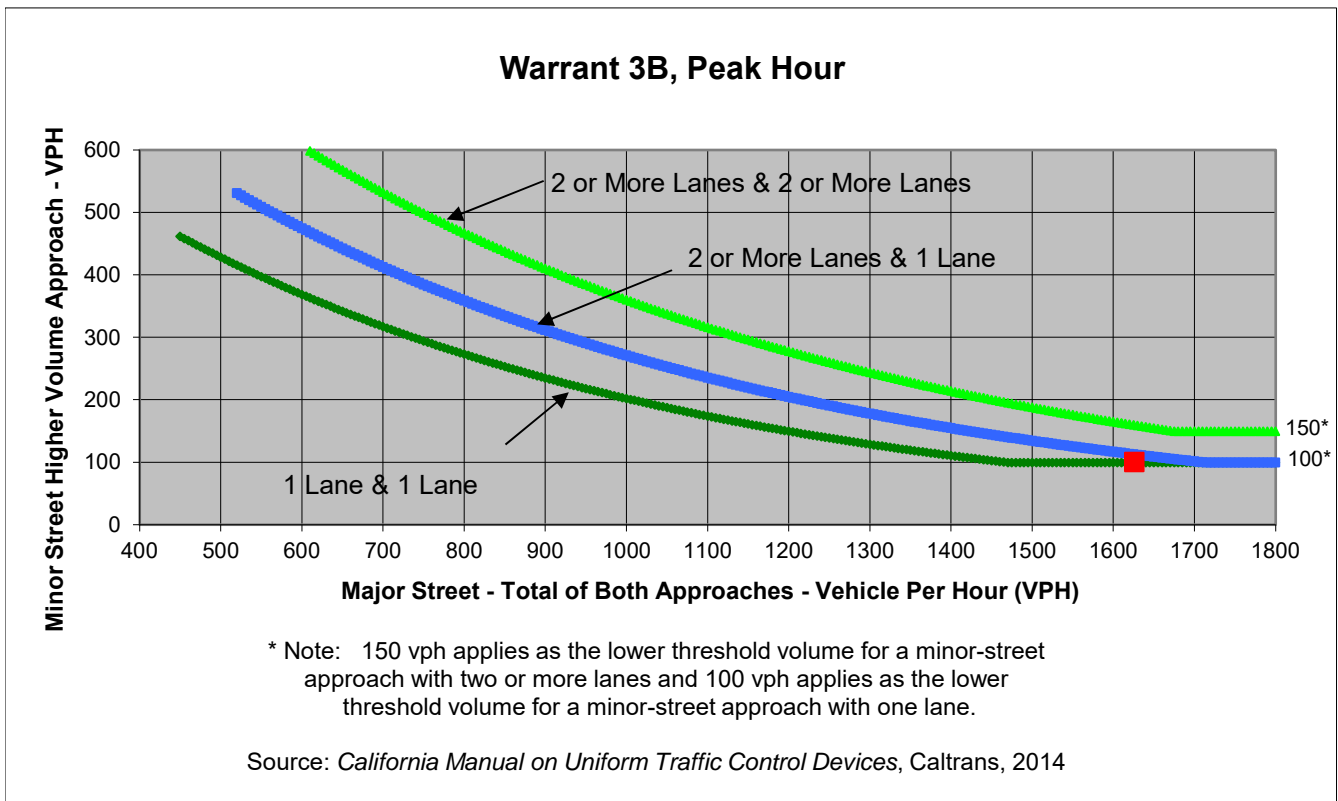
Project Sonoma County Housing Rezone  
 Scenario Existing + Program Conditions  
 Peak Hour PM Peak Hour

Turn Movement Volumes

	NB	SB	EB	WB
Left	20	30	10	71
Through	709	715	10	10
Right	122	30	20	20
Total	851	775	40	101

Major Street Direction

x	North/South
	East/West



	Major Street	Minor Street	Warrant Met
	Old Redwood Highway	Faught Road	
<b>Number of Approach Lanes</b>	<b>2</b>	<b>1</b>	<b><u>NO</u></b>
<b>Traffic Volume (VPH) *</b>	<b>1,626</b>	<b>101</b>	

\* Note: Traffic Volume for Major Street is Total Volume of Both Approaches.  
 Traffic Volume for Minor Street is the Volume of High Volume Approach.





Major Street Old Redwood Highway  
 Minor Street Faught Road

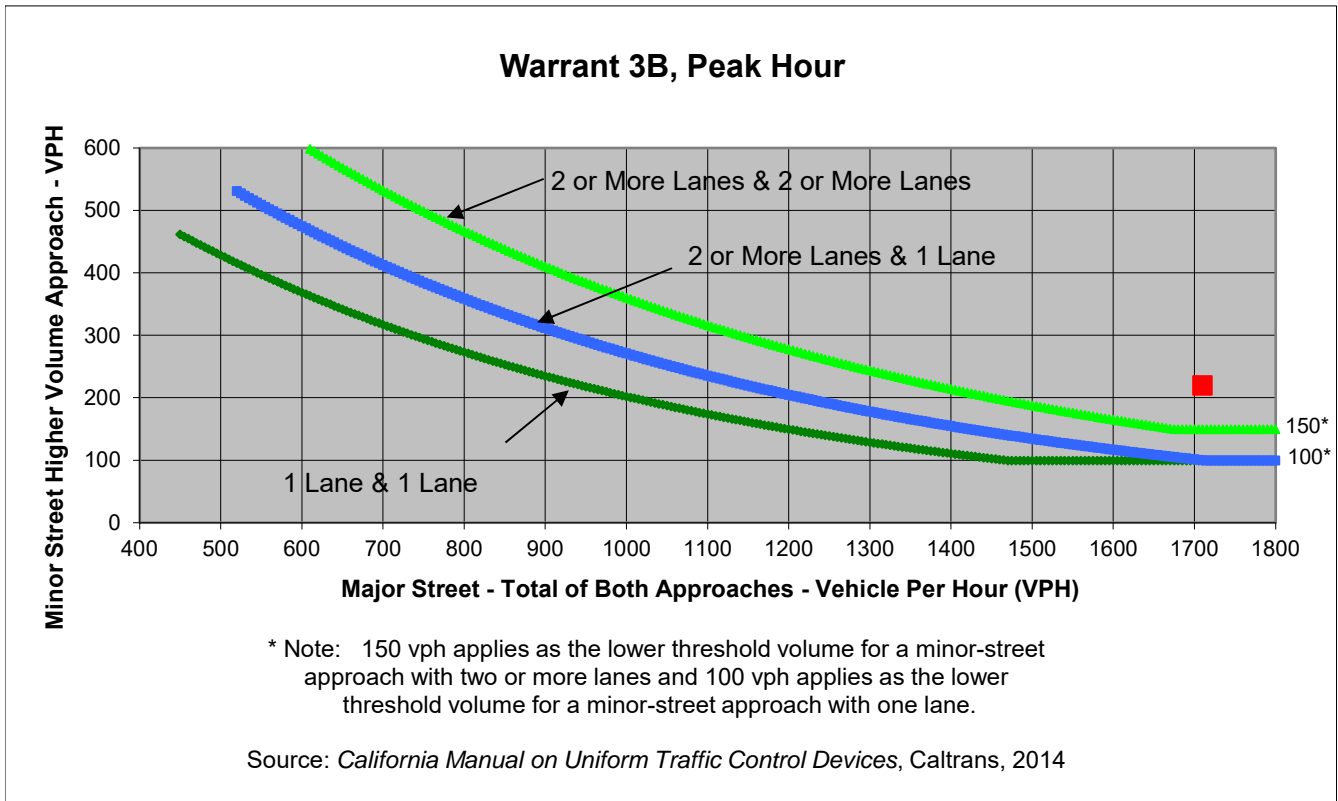
Project Sonoma County Housing Rezone  
 Scenario Cumulative Conditions  
 Peak Hour AM Peak Hour

Turn Movement Volumes

	NB	SB	EB	WB
Left	20	30	60	180
Through	420	1,100	20	20
Right	110	30	30	20
Total	550	1,160	110	220

Major Street Direction

x	North/South
	East/West



	Major Street	Minor Street	Warrant Met
	Old Redwood Highway	Faught Road	
<b>Number of Approach Lanes</b>	<b>2</b>	<b>1</b>	<b>YES</b>
<b>Traffic Volume (VPH) *</b>	<b>1,710</b>	<b>220</b>	

\* Note: Traffic Volume for Major Street is Total Volume of Both Approaches.  
 Traffic Volume for Minor Street is the Volume of High Volume Approach.



Major Street Old Redwood Highway  
 Minor Street Faught Road

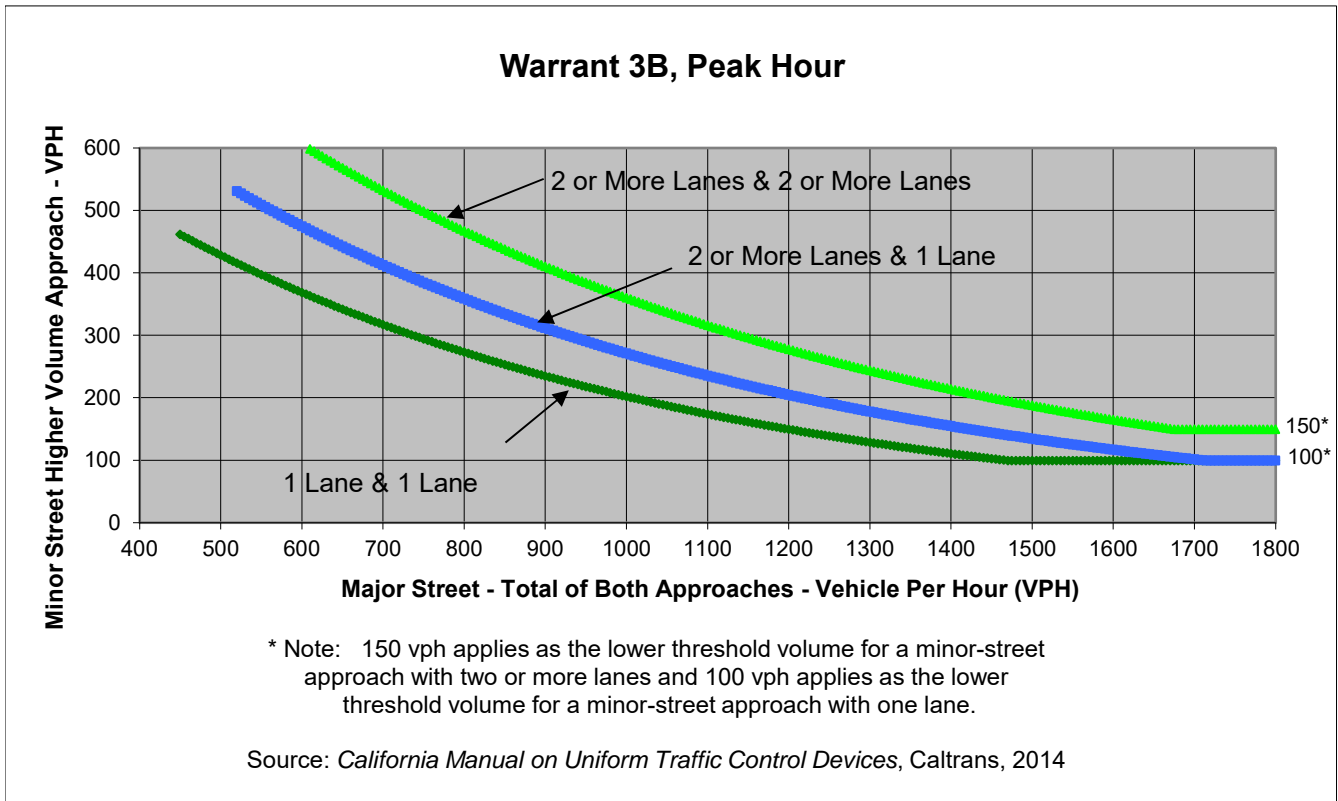
Project Sonoma County Housing Rezone  
 Scenario Cumulative Conditions  
 Peak Hour PM Peak Hour

Turn Movement Volumes

	NB	SB	EB	WB
Left	30	50	20	100
Through	920	990	20	20
Right	170	50	30	60
Total	1,120	1,090	70	180

Major Street Direction

x	North/South
	East/West



	Major Street	Minor Street	Warrant Met
	Old Redwood Highway	Faught Road	
<b>Number of Approach Lanes</b>	<b>2</b>	<b>1</b>	<b>YES</b>
<b>Traffic Volume (VPH) *</b>	<b>2,210</b>	<b>180</b>	

\* Note: Traffic Volume for Major Street is Total Volume of Both Approaches.  
 Traffic Volume for Minor Street is the Volume of High Volume Approach.

Major Street **SR 116/Front Street**  
 Minor Street **Mirabel Road**

Project **Sonoma County Housing Rezone**  
 Scenario **Existing + Program Conditions**  
 Peak Hour **AM Peak Hour**

Turn Movement Volumes

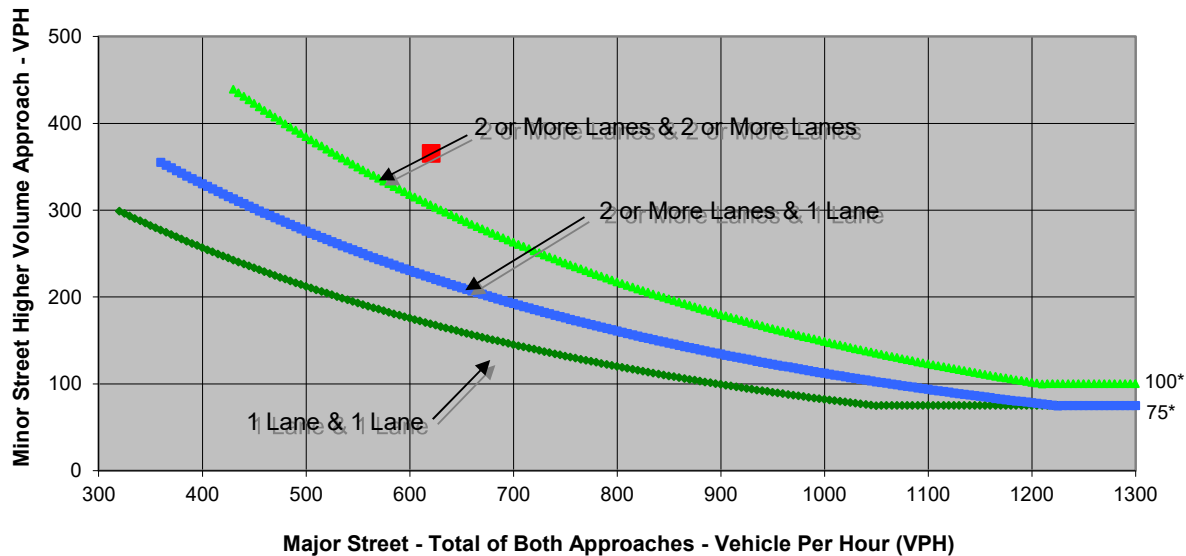
	NB	SB	EB	WB
Left	0	342	65	0
Through	0	0	255	145
Right	0	23	0	156
Total	0	365	320	301

Major Street Direction

	North/South
x	East/West

**Figure 4C-4. Warrant 3B, Peak Hour (70% Factor)**  
 (COMMUNITY LESS THAN 10,000 POPULATION OR

ABOVE 40 MPH ON MAJOR STREET



\* Note: 100 vph applies as the lower threshold volume for a minor-street approach with two or more lanes and 75 vph applies as the lower threshold volume for a minor-street approach with one lane.

Source: California Manual on Uniform Traffic Control Devices, Caltrans, 2014

	Major Street	Minor Street	Warrant Met
	SR 116/Front Street	Mirabel Road	
<b>Number of Approach Lanes</b>	<b>1</b>	<b>2</b>	<b><u>YES</u></b>
<b>Traffic Volume (VPH) *</b>	<b>621</b>	<b>365</b>	

\* Note: Traffic Volume for Major Street is Total Volume of Both Approaches.  
 Traffic Volume for Minor Street is the Volume of High Volume Approach.

Major Street **SR 116/Front Street**  
 Minor Street **Mirabel Road**

Project **Sonoma County Housing Rezone**  
 Scenario **Cumulative Conditions**  
 Peak Hour **AM Peak Hour**

Turn Movement Volumes

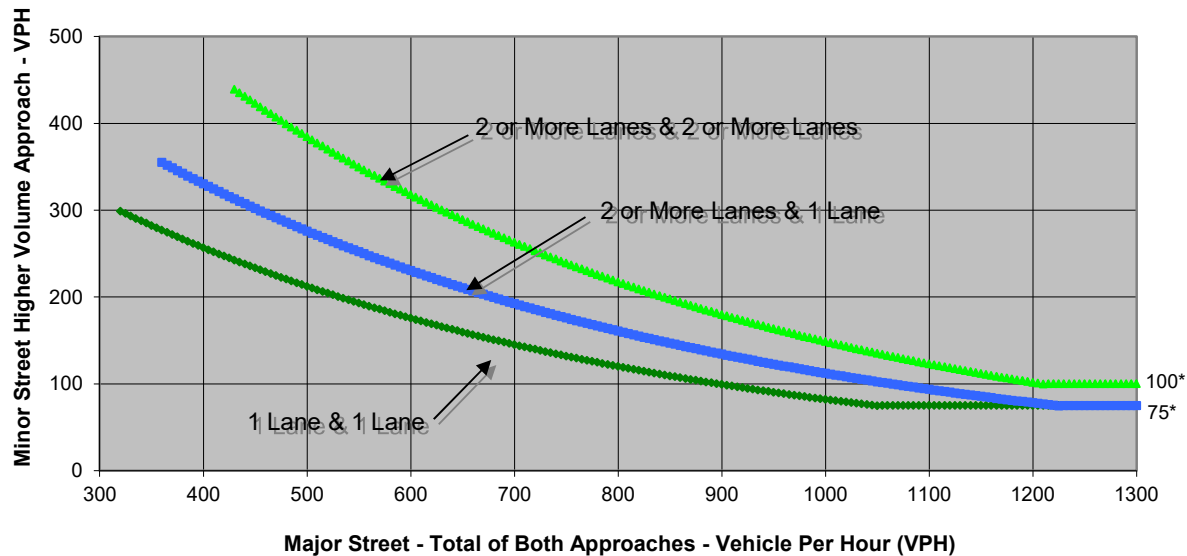
	NB	SB	EB	WB
Left	0	470	100	0
Through	0	0	340	220
Right	0	40	0	210
Total	0	510	440	430

Major Street Direction

	North/South
x	East/West

**Figure 4C-4. Warrant 3B, Peak Hour (70% Factor)**  
 (COMMUNITY LESS THAN 10,000 POPULATION OR

ABOVE 40 MPH ON MAJOR STREET



\* Note: 100 vph applies as the lower threshold volume for a minor-street approach with two or more lanes and 75 vph applies as the lower threshold volume for a minor-street approach with one lane.

Source: California Manual on Uniform Traffic Control Devices, Caltrans, 2014

	Major Street	Minor Street	Warrant Met
	SR 116/Front Street	Mirabel Road	
<b>Number of Approach Lanes</b>	<b>1</b>	<b>2</b>	<b><u>YES</u></b>
<b>Traffic Volume (VPH) *</b>	<b>870</b>	<b>510</b>	

\* Note: Traffic Volume for Major Street is Total Volume of Both Approaches.  
 Traffic Volume for Minor Street is the Volume of High Volume Approach.



Major Street **SR 116/Front Street**  
 Minor Street **Mirabel Road**

Project **Sonoma County Housing Rezone**  
 Scenario **Cumulative Conditions**  
 Peak Hour **PM Peak Hour**

Turn Movement Volumes

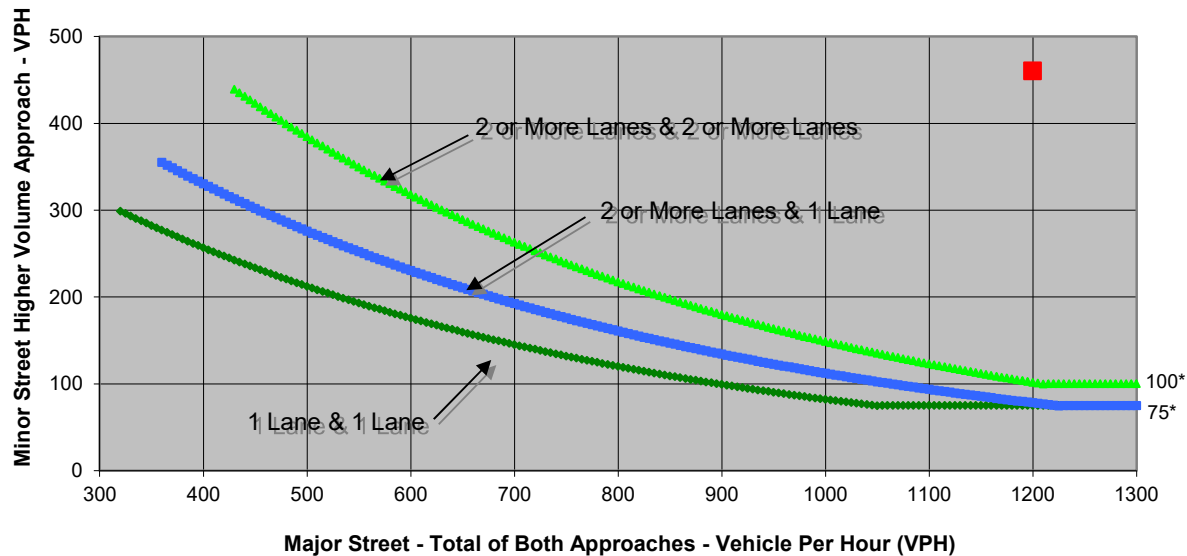
	NB	SB	EB	WB
Left	0	380	50	0
Through	0	0	270	270
Right	0	80	0	610
Total	0	460	320	880

Major Street Direction

	North/South
x	East/West

**Figure 4C-4. Warrant 3B, Peak Hour (70% Factor)**  
 (COMMUNITY LESS THAN 10,000 POPULATION OR

ABOVE 40 MPH ON MAJOR STREET



\* Note: 100 vph applies as the lower threshold volume for a minor-street approach with two or more lanes and 75 vph applies as the lower threshold volume for a minor-street approach with one lane.

Source: California Manual on Uniform Traffic Control Devices, Caltrans, 2014

	Major Street	Minor Street	Warrant Met
	SR 116/Front Street	Mirabel Road	
<b>Number of Approach Lanes</b>	<b>1</b>	<b>2</b>	<b><u>YES</u></b>
<b>Traffic Volume (VPH) *</b>	<b>1,200</b>	<b>460</b>	

\* Note: Traffic Volume for Major Street is Total Volume of Both Approaches.  
 Traffic Volume for Minor Street is the Volume of High Volume Approach.



Major Street Todd Road  
 Minor Street Moorland Avenue

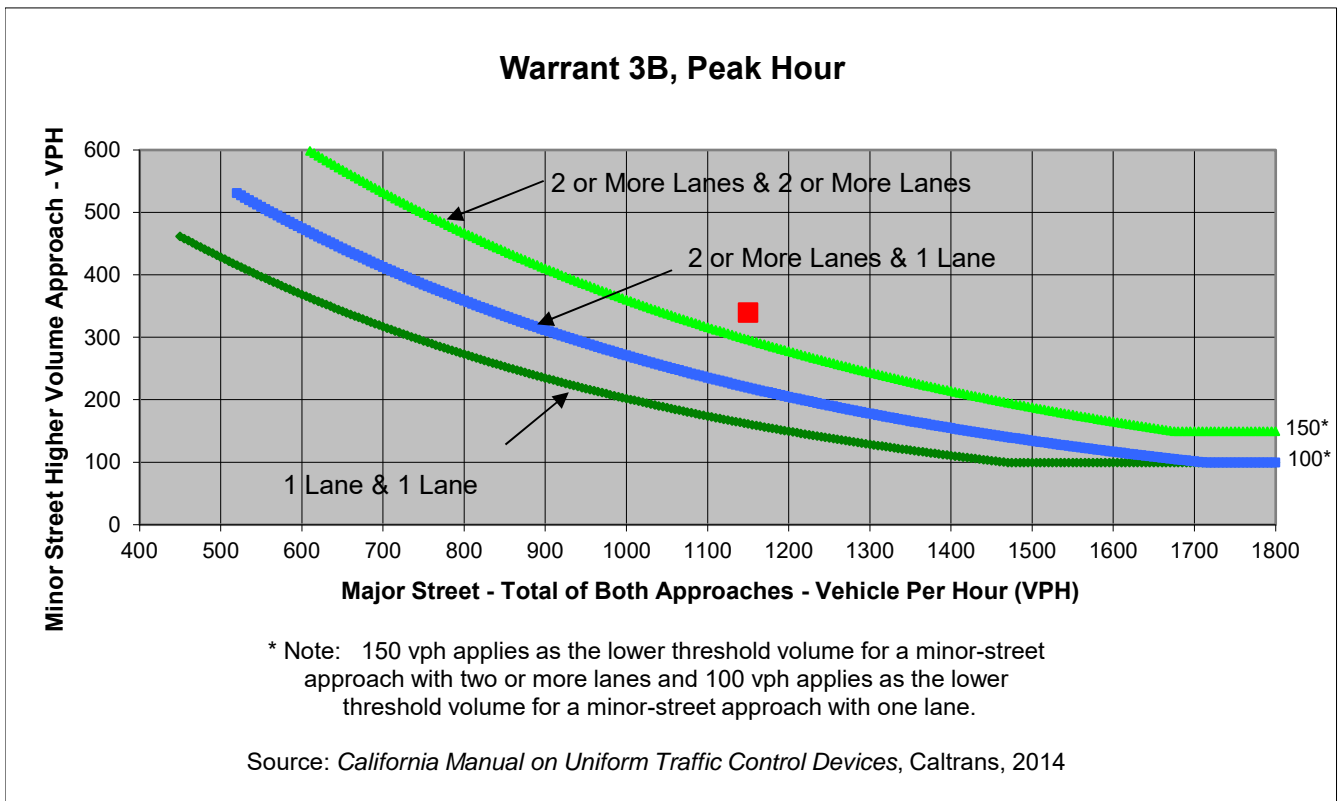
Project Sonoma County Housing Rezone  
 Scenario Existing Conditions  
 Peak Hour AM Peak Hour

Turn Movement Volumes

	NB	SB	EB	WB
Left	10	260	50	10
Through	10	10	360	410
Right	10	70	10	310
Total	30	340	420	730

Major Street Direction

	North/South
x	East/West



	Major Street	Minor Street	Warrant Met
	Todd Road	Moorland Avenue	
<b>Number of Approach Lanes</b>	<b>2</b>	<b>2</b>	<b><u>YES</u></b>
<b>Traffic Volume (VPH) *</b>	<b>1,150</b>	<b>340</b>	

\* Note: Traffic Volume for Major Street is Total Volume of Both Approaches.  
 Traffic Volume for Minor Street is the Volume of High Volume Approach.



Major Street Todd Road  
 Minor Street Moorland Avenue

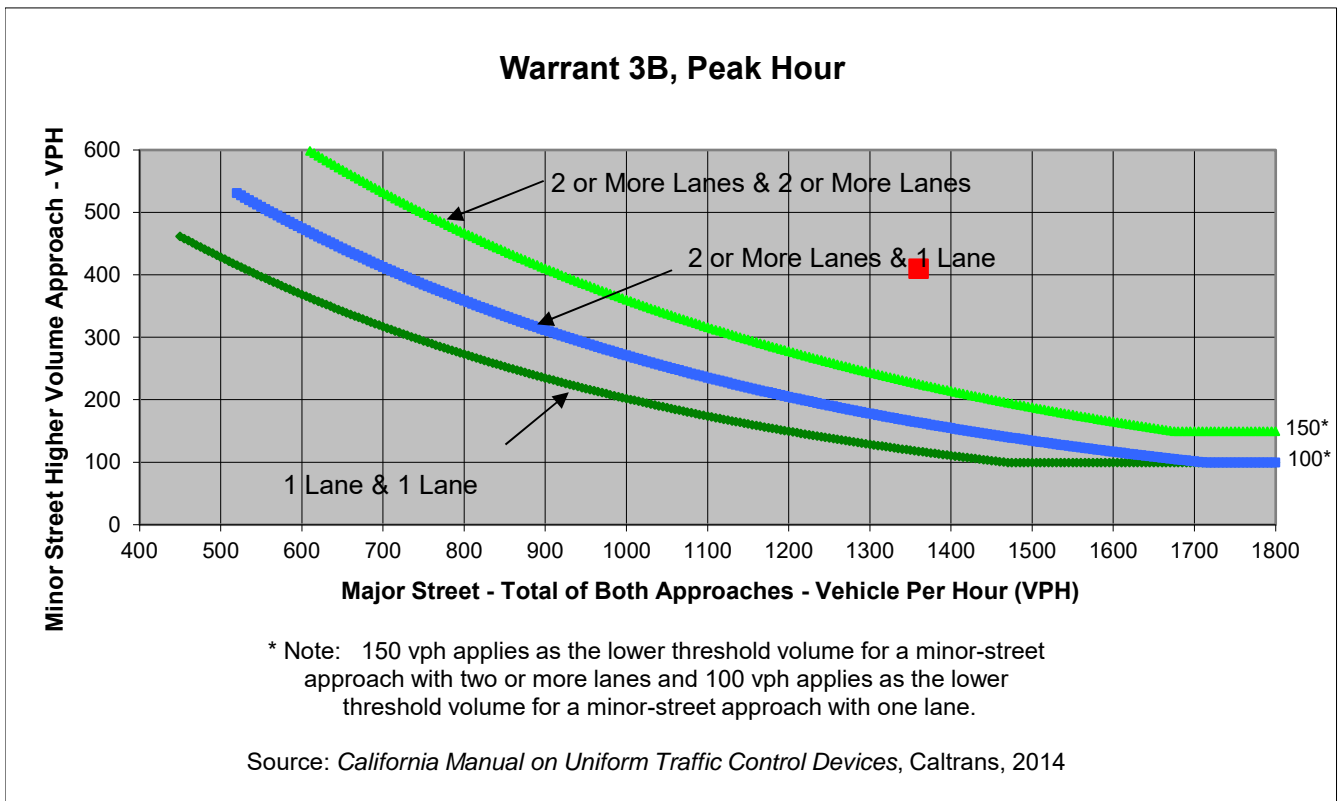
Project Sonoma County Housing Rezone  
 Scenario Existing Conditions  
 Peak Hour PM Peak Hour

Turn Movement Volumes

	NB	SB	EB	WB
Left	10	360	50	20
Through	20	20	520	420
Right	20	30	10	340
Total	50	410	580	780

Major Street Direction

	North/South
x	East/West



	Major Street	Minor Street	Warrant Met
	Todd Road	Moorland Avenue	
<b>Number of Approach Lanes</b>	<b>2</b>	<b>2</b>	<b><u>YES</u></b>
<b>Traffic Volume (VPH) *</b>	<b>1,360</b>	<b>410</b>	

\* Note: Traffic Volume for Major Street is Total Volume of Both Approches.  
 Traffic Volume for Minor Street is the Volume of High Volume Approach.



Major Street Verano Avenue  
 Minor Street Riverside Drive

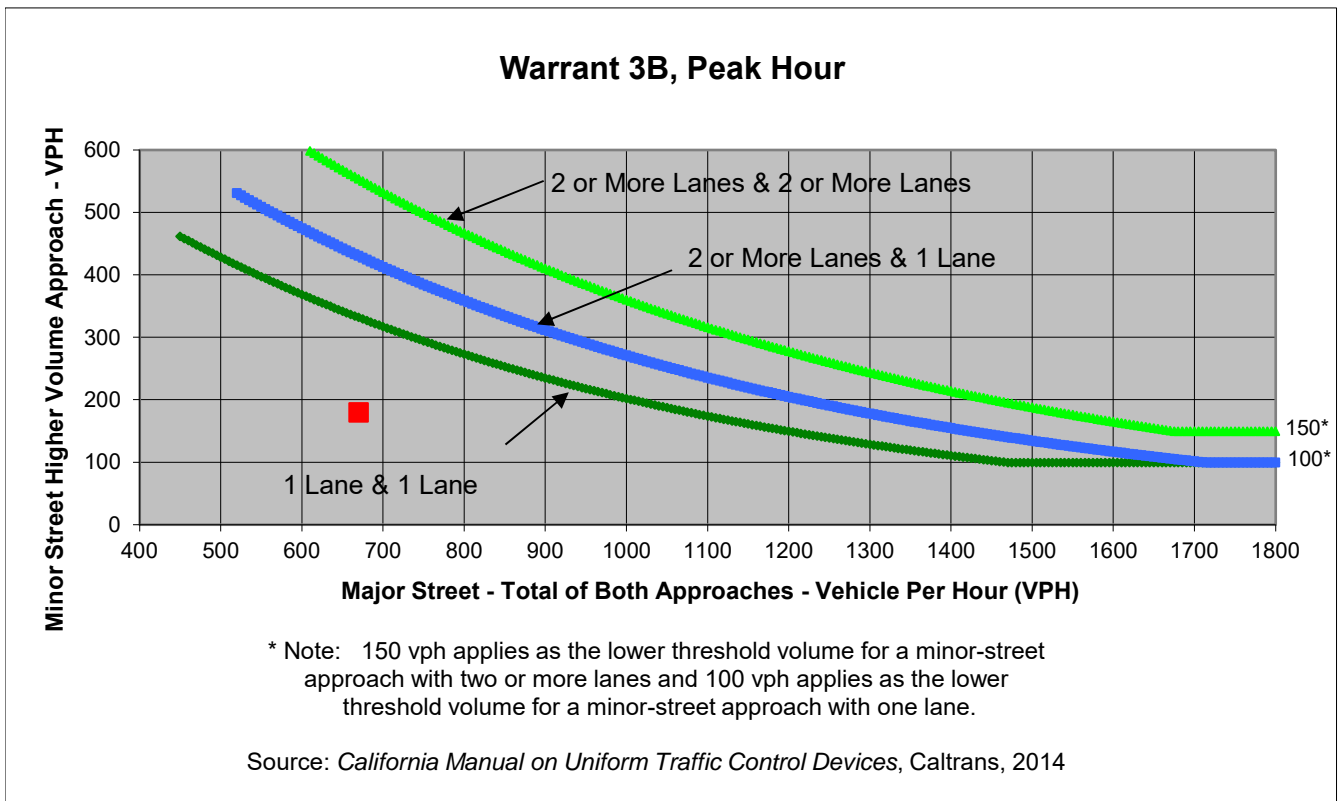
Project Sonoma County Housing Rezone  
 Scenario Existing Conditions  
 Peak Hour AM Peak Hour

Turn Movement Volumes

	NB	SB	EB	WB
Left	20	120	40	90
Through	20	20	260	220
Right	20	40	10	50
Total	60	180	310	360

Major Street Direction

	North/South
x	East/West



	Major Street	Minor Street	Warrant Met
	Verano Avenue	Riverside Drive	
<b>Number of Approach Lanes</b>	<b>1</b>	<b>1</b>	<b><u>NO</u></b>
<b>Traffic Volume (VPH) *</b>	<b>670</b>	<b>180</b>	

\* Note: Traffic Volume for Major Street is Total Volume of Both Approaches.  
 Traffic Volume for Minor Street is the Volume of High Volume Approach.





Major Street Verano Avenue  
 Minor Street Riverside Drive

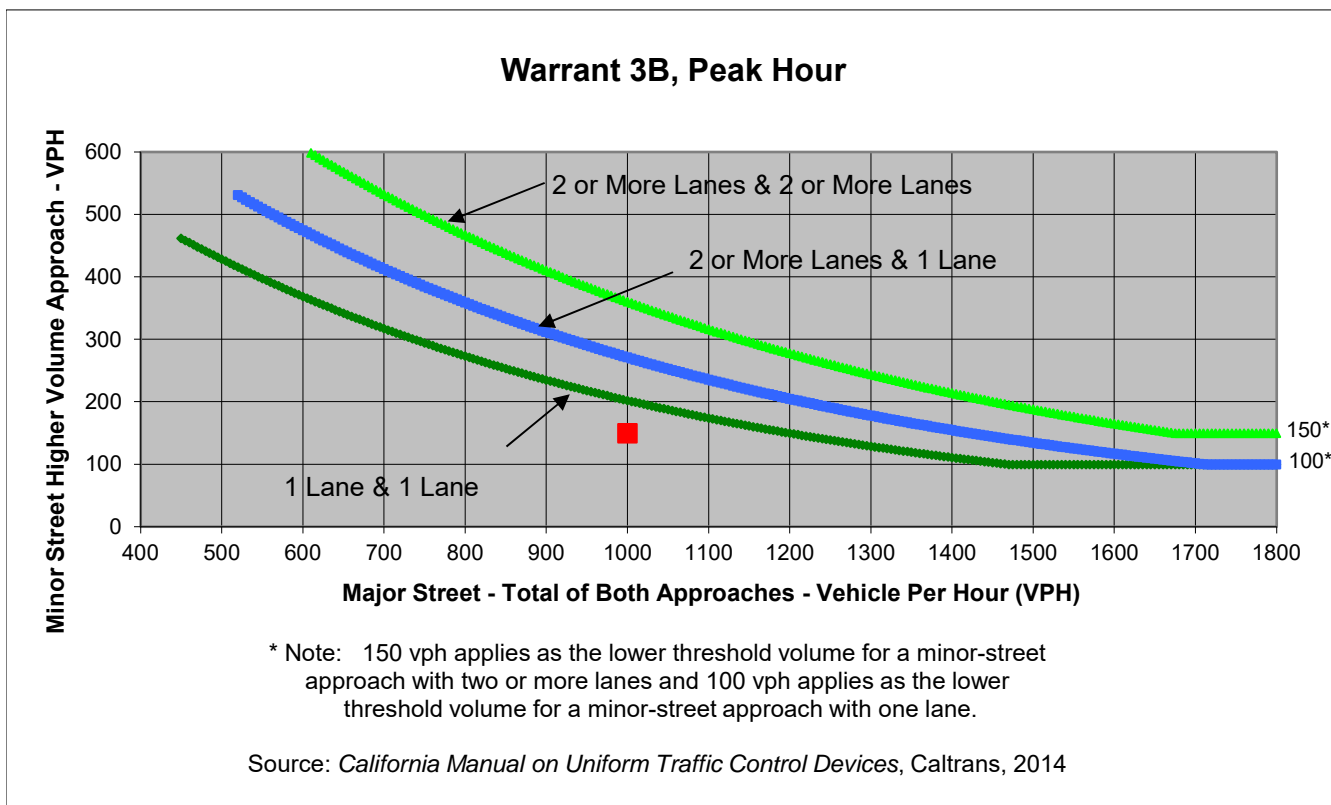
Project Sonoma County Housing Rezone  
 Scenario Existing Conditions  
 Peak Hour PM Peak Hour

Turn Movement Volumes

	NB	SB	EB	WB
Left	20	70	50	70
Through	80	50	290	350
Right	20	30	110	130
Total	120	150	450	550

Major Street Direction

	North/South
x	East/West



	Major Street	Minor Street	Warrant Met
	Verano Avenue	Riverside Drive	
<b>Number of Approach Lanes</b>	<b>1</b>	<b>1</b>	<b><u>NO</u></b>
<b>Traffic Volume (VPH) *</b>	<b>1,000</b>	<b>150</b>	

\* Note: Traffic Volume for Major Street is Total Volume of Both Approaches.  
 Traffic Volume for Minor Street is the Volume of High Volume Approach.



Major Street Verano Avenue  
 Minor Street Riverside Drive

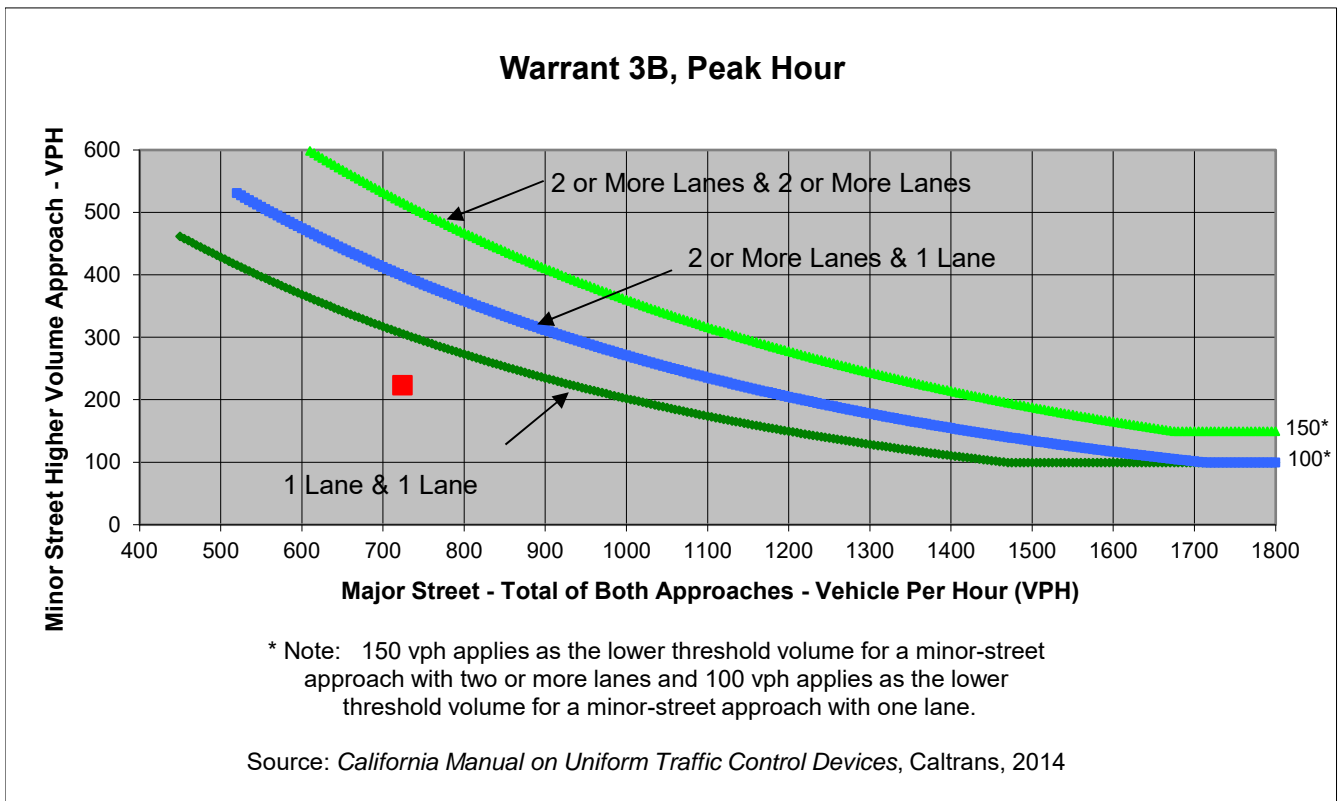
Project Sonoma County Housing Rezone  
 Scenario Existing + Program Conditions  
 Peak Hour AM Peak Hour

Turn Movement Volumes

	NB	SB	EB	WB
Left	20	127	42	90
Through	20	50	270	260
Right	20	47	10	52
Total	60	224	322	402

Major Street Direction

	North/South
x	East/West



	Major Street	Minor Street	Warrant Met
	Verano Avenue	Riverside Drive	
<b>Number of Approach Lanes</b>	<b>1</b>	<b>1</b>	<b><u>NO</u></b>
<b>Traffic Volume (VPH) *</b>	<b>724</b>	<b>224</b>	

\* Note: Traffic Volume for Major Street is Total Volume of Both Approaches.  
 Traffic Volume for Minor Street is the Volume of High Volume Approach.



Major Street Verano Avenue  
 Minor Street Riverside Drive

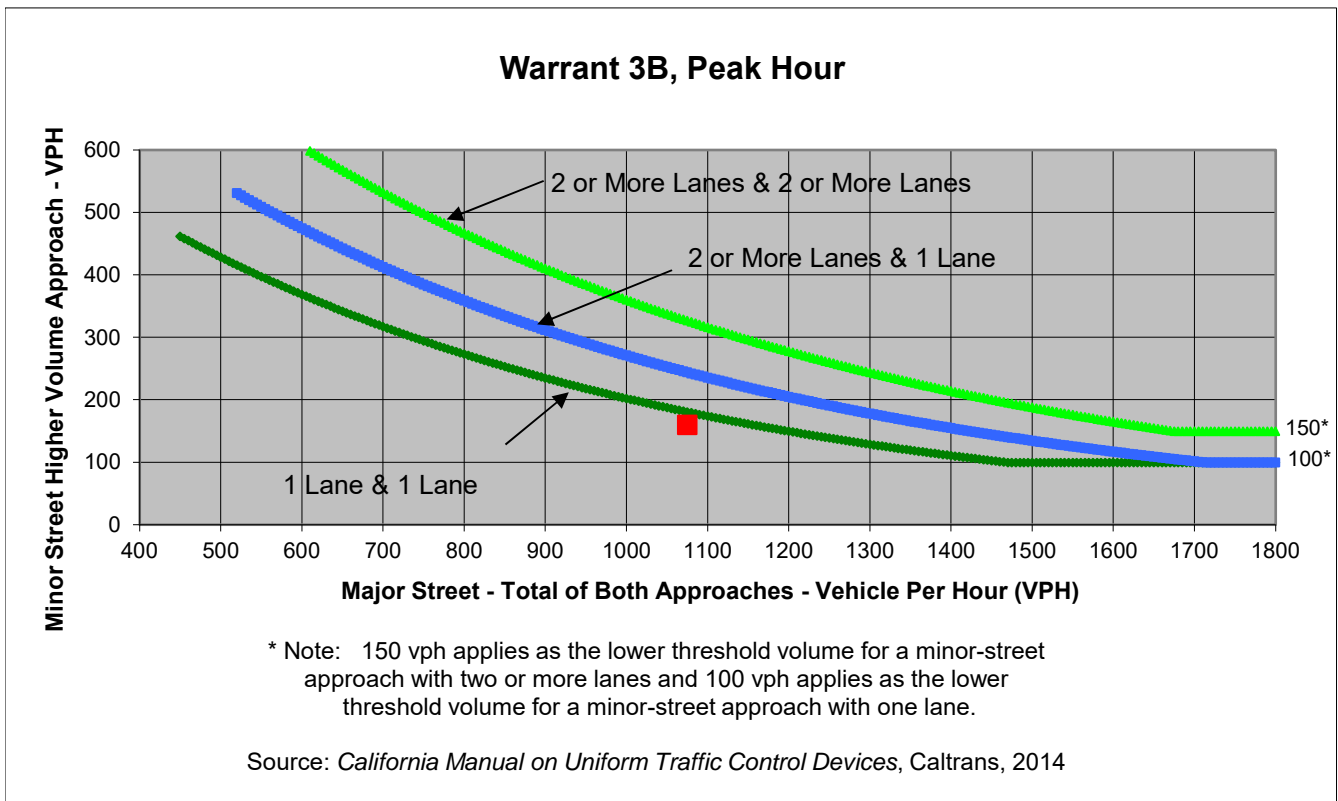
Project Sonoma County Housing Rezone  
 Scenario Existing + Program Conditions  
 Peak Hour PM Peak Hour

Turn Movement Volumes

	NB	SB	EB	WB
Left	20	75	55	70
Through	80	50	325	375
Right	20	35	110	140
Total	120	160	490	585

Major Street Direction

	North/South
x	East/West



	Major Street	Minor Street	Warrant Met
	Verano Avenue	Riverside Drive	
<b>Number of Approach Lanes</b>	<b>1</b>	<b>1</b>	<b><u>NO</u></b>
<b>Traffic Volume (VPH) *</b>	<b>1,075</b>	<b>160</b>	

\* Note: Traffic Volume for Major Street is Total Volume of Both Approaches.  
 Traffic Volume for Minor Street is the Volume of High Volume Approach.



Major Street Verano Avenue  
 Minor Street Riverside Drive

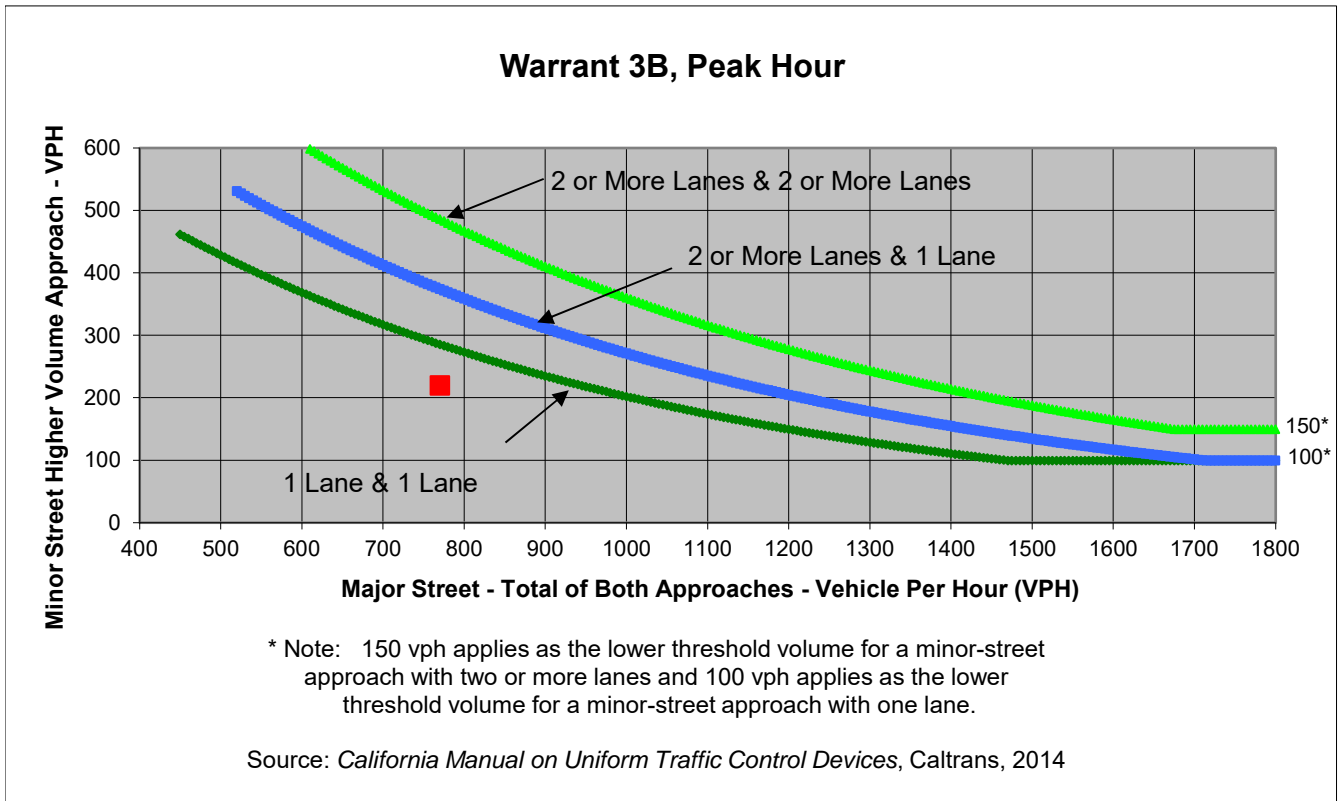
Project Sonoma County Housing Rezone  
 Scenario Cumulative Conditions  
 Peak Hour AM Peak Hour

Turn Movement Volumes

	NB	SB	EB	WB
Left	30	140	50	100
Through	30	30	290	250
Right	30	50	20	60
Total	90	220	360	410

Major Street Direction

	North/South
x	East/West



	Major Street	Minor Street	Warrant Met
	Verano Avenue	Riverside Drive	
<b>Number of Approach Lanes</b>	<b>1</b>	<b>1</b>	<b><u>NO</u></b>
<b>Traffic Volume (VPH) *</b>	<b>770</b>	<b>220</b>	

\* Note: Traffic Volume for Major Street is Total Volume of Both Approaches.  
 Traffic Volume for Minor Street is the Volume of High Volume Approach.



Major Street Verano Avenue  
 Minor Street Riverside Drive

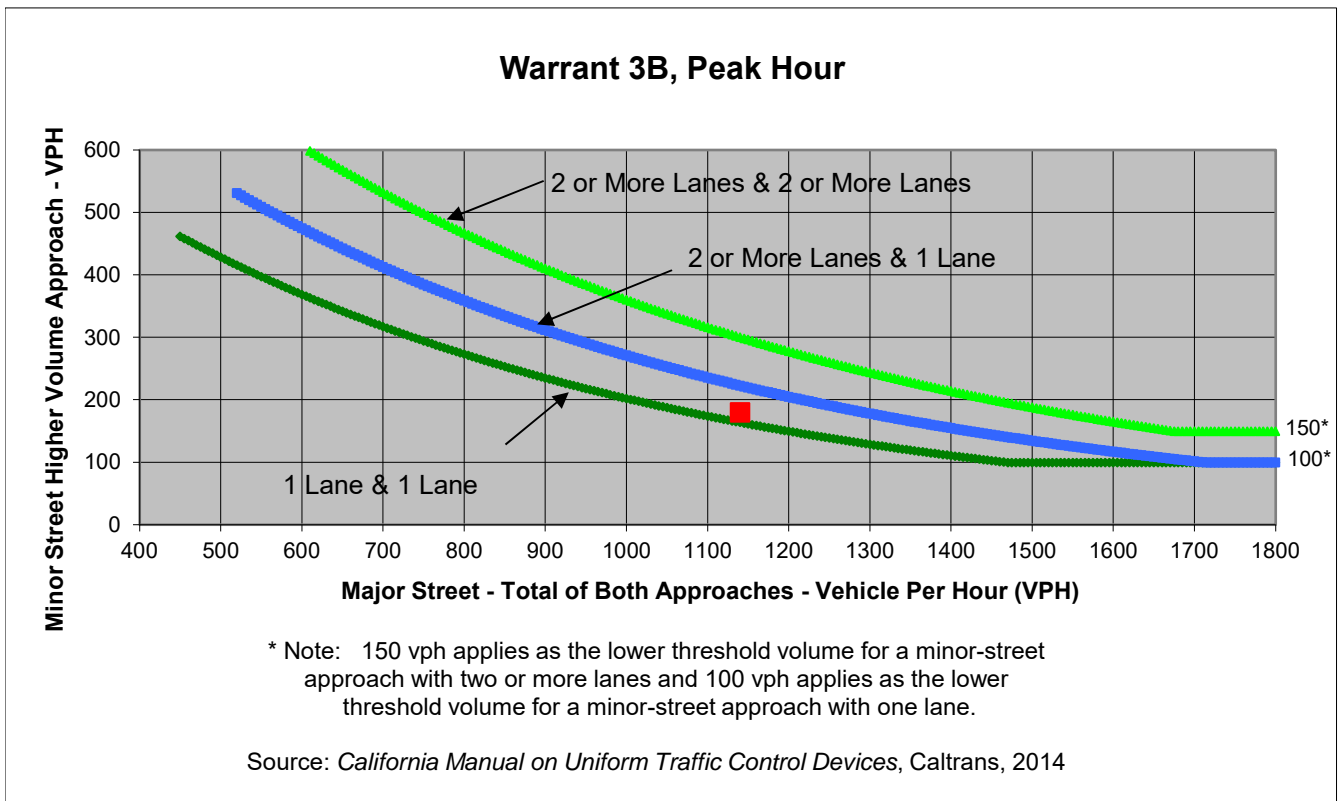
Project Sonoma County Housing Rezone  
 Scenario Cumulative Conditions  
 Peak Hour PM Peak Hour

Turn Movement Volumes

	NB	SB	EB	WB
Left	30	80	60	80
Through	90	60	330	390
Right	30	40	130	150
Total	150	180	520	620

Major Street Direction

	North/South
x	East/West



	Major Street	Minor Street	Warrant Met
	Verano Avenue	Riverside Drive	
<b>Number of Approach Lanes</b>	<b>1</b>	<b>1</b>	<b>YES</b>
<b>Traffic Volume (VPH) *</b>	<b>1,140</b>	<b>180</b>	

\* Note: Traffic Volume for Major Street is Total Volume of Both Approaches.  
 Traffic Volume for Minor Street is the Volume of High Volume Approach.



Major Street Verano Avenue  
 Minor Street Riverside Drive

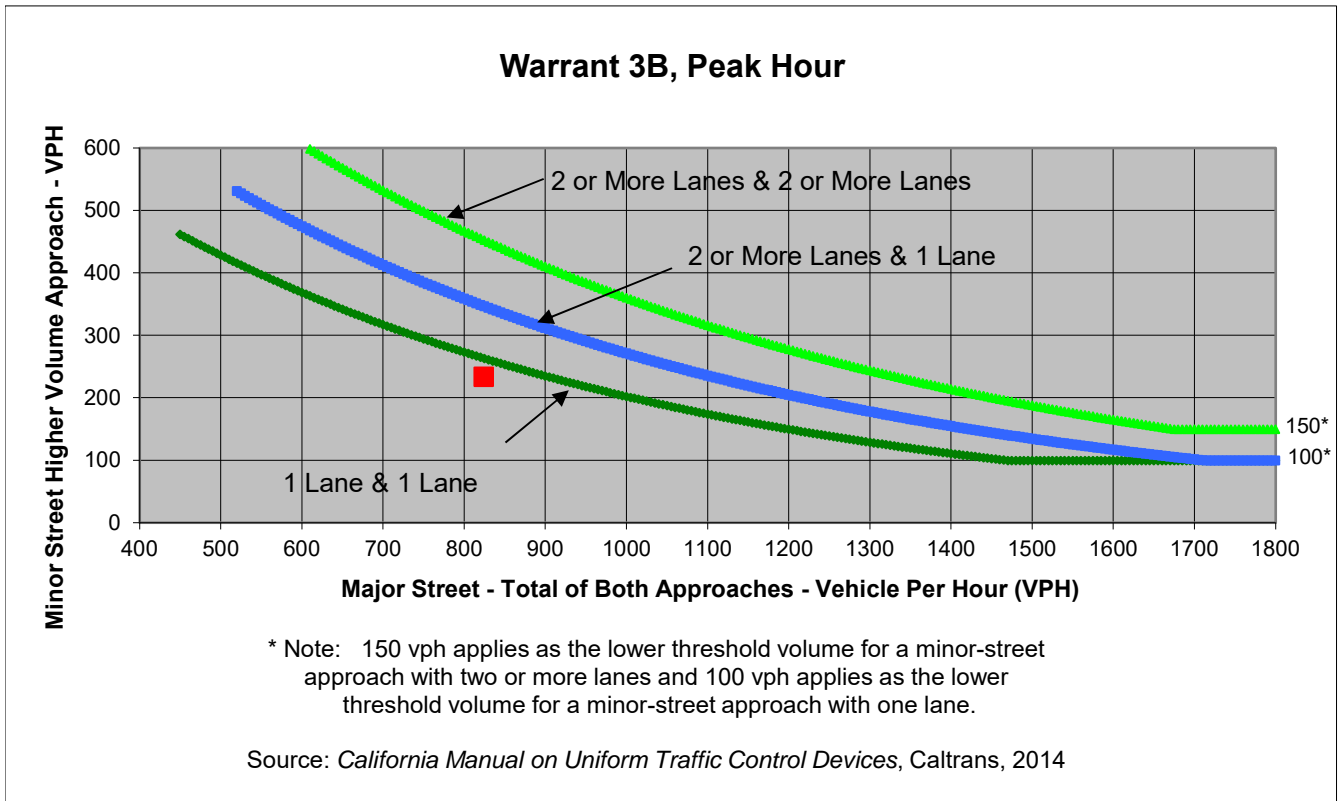
Project Sonoma County Housing Rezone  
 Scenario Cumulative + Program Conditions  
 Peak Hour AM Peak Hour

Turn Movement Volumes

	NB	SB	EB	WB
Left	30	147	52	100
Through	30	30	300	290
Right	30	57	20	62
Total	90	234	372	452

Major Street Direction

	North/South
x	East/West



	Major Street	Minor Street	Warrant Met
	Verano Avenue	Riverside Drive	
<b>Number of Approach Lanes</b>	<b>1</b>	<b>1</b>	<b><u>NO</u></b>
<b>Traffic Volume (VPH) *</b>	<b>824</b>	<b>234</b>	

\* Note: Traffic Volume for Major Street is Total Volume of Both Approaches.  
 Traffic Volume for Minor Street is the Volume of High Volume Approach.



Major Street Verano Avenue  
 Minor Street Riverside Drive

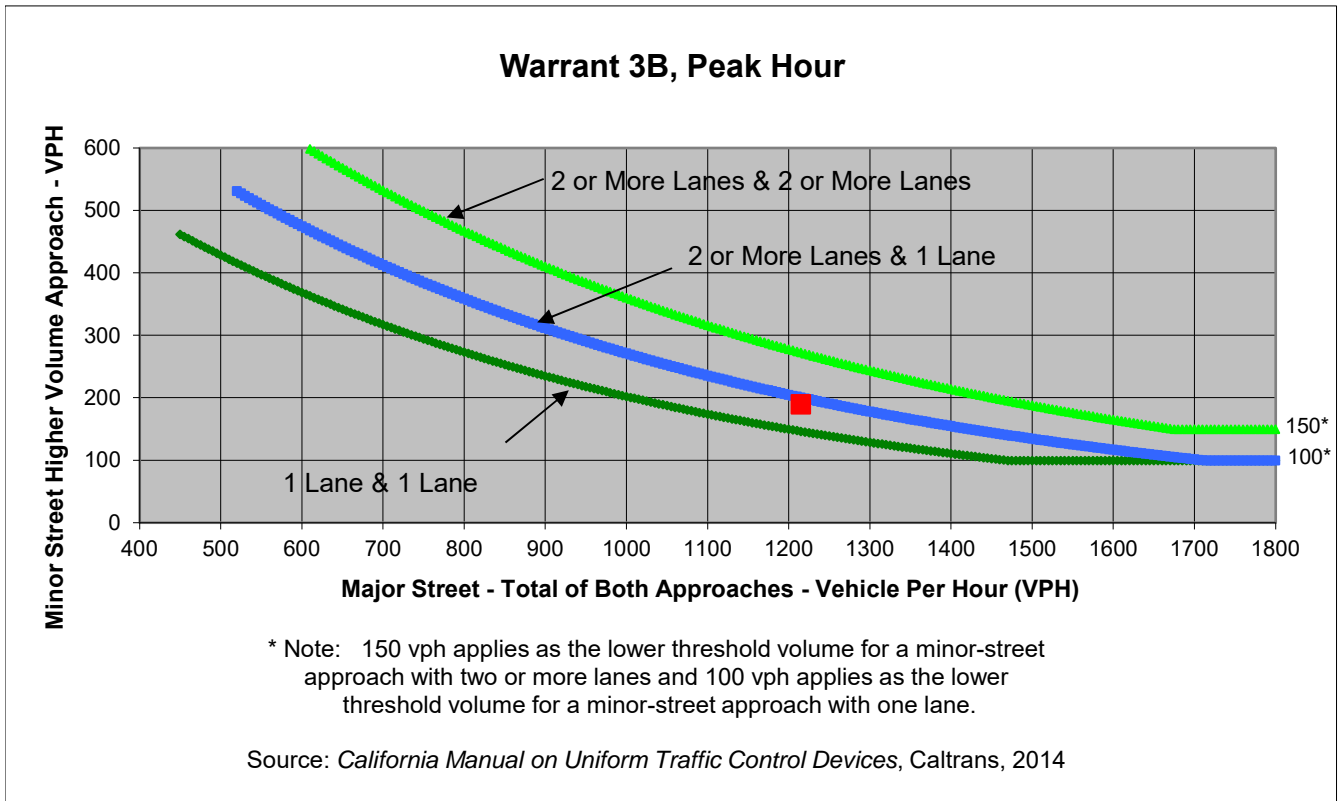
Project Sonoma County Housing Rezone  
 Scenario Cumulative + Program Conditions  
 Peak Hour PM Peak Hour

Turn Movement Volumes

	NB	SB	EB	WB
Left	30	85	65	80
Through	90	60	365	415
Right	30	45	130	160
Total	150	190	560	655

Major Street Direction

                     North/South  
                    x East/West



	<b>Major Street</b>	<b>Minor Street</b>	<b>Warrant Met</b>
	Verano Avenue	Riverside Drive	
<b>Number of Approach Lanes</b>	<b>1</b>	<b>1</b>	<b><u>YES</u></b>
<b>Traffic Volume (VPH) *</b>	<b>1,215</b>	<b>190</b>	

\* Note: Traffic Volume for Major Street is Total Volume of Both Approaches.  
 Traffic Volume for Minor Street is the Volume of High Volume Approach.



Major Street Bodega Avenue  
 Minor Street Paula Lane

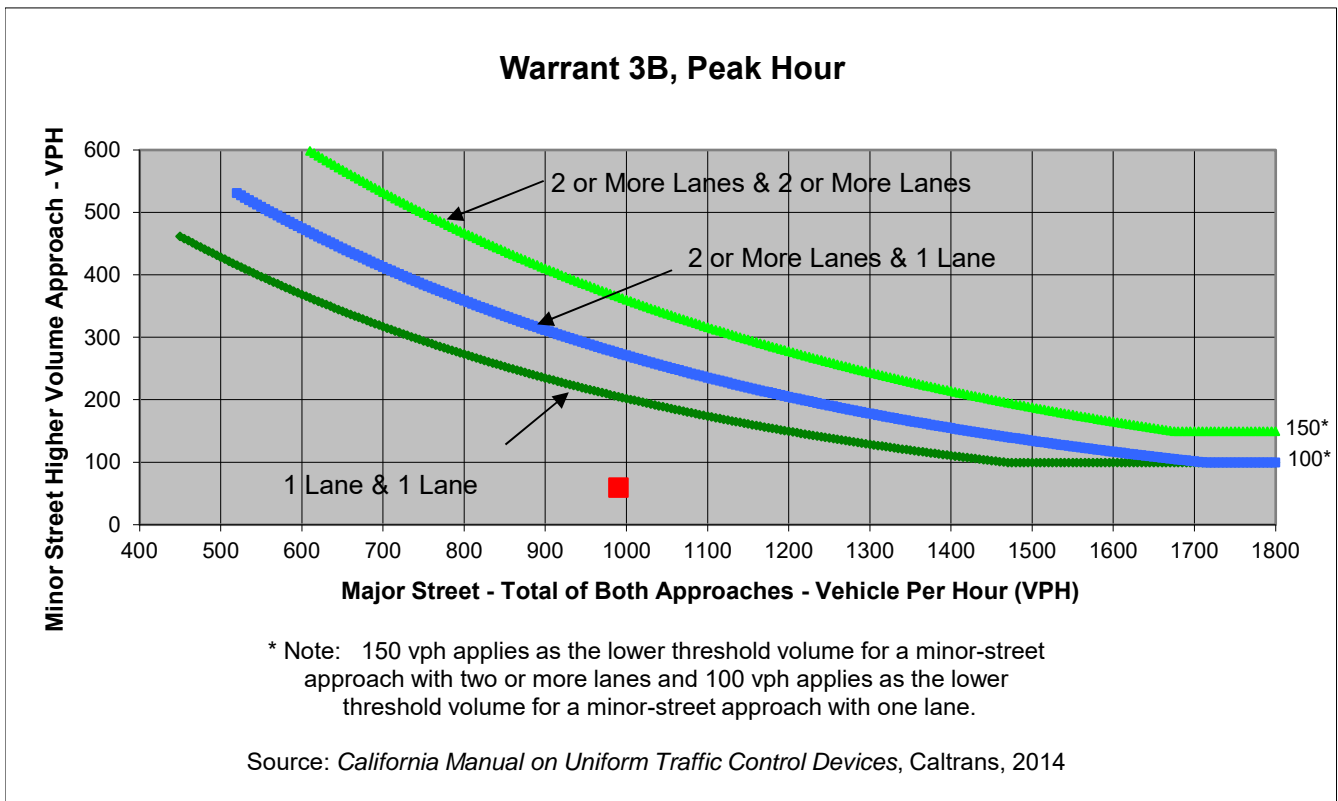
Project Sonoma County Housing Rezone  
 Scenario Cumulative Conditions  
 Peak Hour PM Peak Hour

Turn Movement Volumes

	NB	SB	EB	WB
Left	0	30	30	0
Through	0	0	420	510
Right	0	30	0	30
Total	0	60	450	540

Major Street Direction

                     North/South  
                    x East/West



	Major Street	Minor Street	Warrant Met
	Bodega Avenue	Paula Lane	
<b>Number of Approach Lanes</b>	<b>1</b>	<b>1</b>	<b><u>NO</u></b>
<b>Traffic Volume (VPH) *</b>	<b>990</b>	<b>60</b>	

\* Note: Traffic Volume for Major Street is Total Volume of Both Approaches.  
 Traffic Volume for Minor Street is the Volume of High Volume Approach.





Major Street Bodega Avenue  
 Minor Street Paula Lane

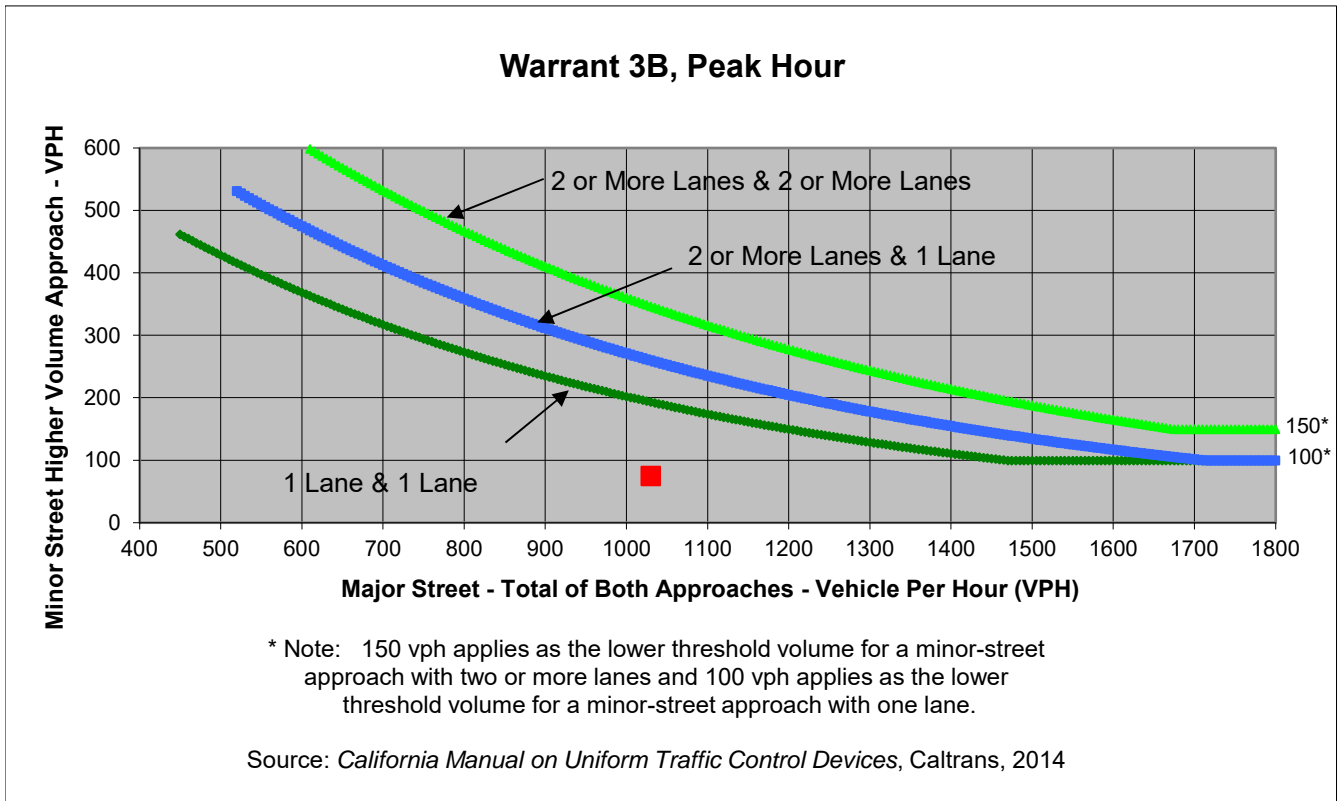
Project Sonoma County Housing Rezone  
 Scenario Cumulative Conditions  
 Peak Hour PM Peak Hour

Turn Movement Volumes

	NB	SB	EB	WB
Left	5	35	30	25
Through	5	10	425	515
Right	20	30	5	30
Total	30	75	460	570

Major Street Direction

                     North/South  
                    x East/West



	Major Street	Minor Street	Warrant Met
	Bodega Avenue	Paula Lane	
<b>Number of Approach Lanes</b>	<b>1</b>	<b>1</b>	<b><u>NO</u></b>
<b>Traffic Volume (VPH) *</b>	<b>1,030</b>	<b>75</b>	

\* Note: Traffic Volume for Major Street is Total Volume of Both Approaches.  
 Traffic Volume for Minor Street is the Volume of High Volume Approach.

# Appendix WSA

---

Water Supply Assessment

## Technical Memorandum

**Date:** May 11, 2022

**Project:** Larkfield Water Supply Assessment

**To:** Candace Coleman  
California American Water

**From:** Stephanie Ard, PE  
Marshall Kosaka, PE  
MurraySmith

**Reviewed By:** Linda Scroggs, PE  
MurraySmith

**Re:** Larkfield Water Supply Assessment

---

### 1.0 Introduction and Background

On November 24, 2021, Sonoma County Permit and Resource Management Department (Permit Sonoma) sent California American Water (CAW) a letter via email requesting a water supply assessment (WSA) for the rezoning of eight parcels known as the Larkfield Sites (Sites). The Sites are being rezoned for increased density to accommodate the Sonoma County's (County) share of the Bay Area's Regional Housing Need Allocation.

This technical memorandum is intended to provide sufficient information to allow CAW to assess its ability to supply water to the Sites, in accordance with the requirements of Senate Bill 610 (SB 610) and Senate Bill 221 (SB 221) (California Water Code sections 10910, et seq, and Government Code Sections 66473, et seq, respectively. Permit Sonoma stated in its November 24th letter that a WSA is required for the proposed rezoning of the Sites to account for an increase of 10 percent or more of CAW's existing service connections in the Larkfield service area, thereby meeting the definition of "project" as provided in Water Code § 10912(b).

### 2.0 Project Description and Rezoning

To meet the housing needs of people at all income levels, the State set a regional growth target naming the total number of new homes each region needs to build. The County's assigned share of the region's growth target for the next cycle is 3,881 housing units, which is a significant increase over the allocation of 515 for the current cycle. To help accommodate this significant increase, Sonoma County is proposing to rezone the Sites.

The Sites consist of eight parcels and approximately 12.87 acres located in the northwest of CAW’s Larkfield service area and shown in **Figure 1**. The County proposes to rezone these parcels as shown in **Table 1**. As the table shows, the rezoning will increase the potential number of dwelling units (DU) from 62 units to 305 units.

On April 22, 2022, Marshall Kosaka (Murraysmith); Eric Gage, Chelsea Holup, and Ross Markey (Sonoma County); and Katherine Green and Darcy Kremin (Rincon Consultants) discussed inconsistencies between parcel acreages listed in the WSA request and Sonoma County’s GIS parcel data. It was concluded that parcel acreages in **Table 1** represent the latest GIS data available from the County.

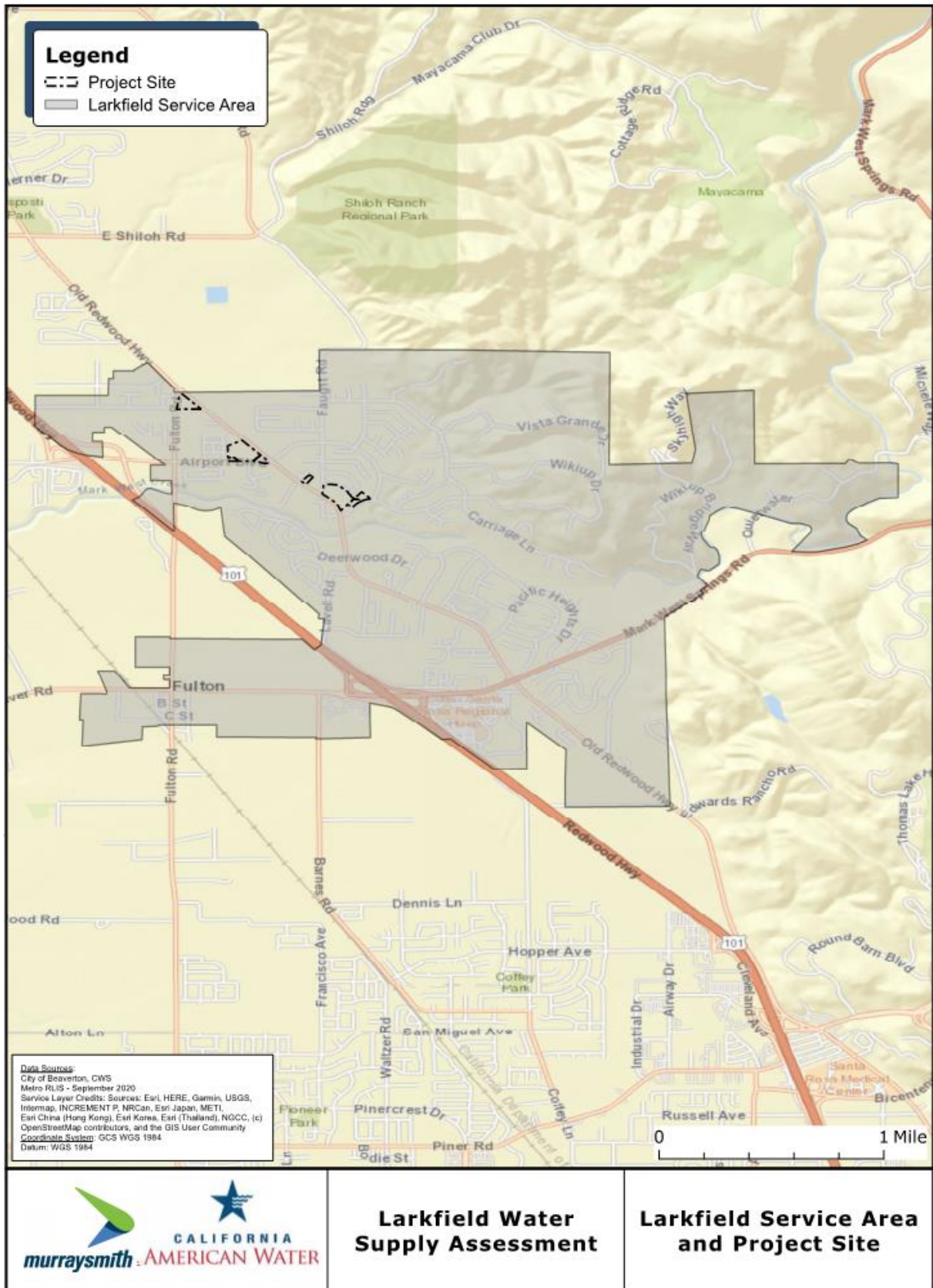
**Table 1 | Existing & Proposed Zoning of Parcels**

EIR ID	Parcel ID	Area (ac)	Existing			Proposed		
			Zoning Description <sup>1</sup>	Max Density (DU/ac)	Units	Zoning Description	Max Density (DU/ac)	Units
LAR-1	039-320-051	1.78	Planned Community <sup>2</sup>	7 <sup>3</sup>	12	Residential	11	97
		2.59	Limited Commercial	n/a	0			
LAR-2	039-040-040	0.76	Office Buildings	n/a	0	Residential	11	16
LAR-3	039-025-060	0.45	Office Buildings	n/a	0	Residential	11	16
LAR-4	039-025-026	0.29	Residential	9	2 <sup>4</sup>	Residential	11	7
LAR-5	039-025-028	4.49	Residential	9	41 <sup>4</sup>	Residential	11	99
LAR-6	039-040-035	0.51	Office Buildings	n/a	0	Residential	11	14
LAR-7	039-380-018	1.51	Residential	5	7	Residential	11	44
LAR-8	039-390-022	0.46	Office Buildings	n/a	0	Residential	24	12
<b>Total</b>		<b>12.84</b>			<b>62</b>			<b>305</b>

Notes:

1. A detailed summary of the zoning terminology can be found at [sonomacounty.ca.gov/PRMD/Services/Zoning-and-Parcel-Report/Zoning-Codes-County/](http://sonomacounty.ca.gov/PRMD/Services/Zoning-and-Parcel-Report/Zoning-Codes-County/).
2. Special purpose zone allowing a diverse mix of uses, buildings, structures, lot sizes, and open spaces.
3. Based on minimum lot size of 6,000 square feet per Sec. 26-14-040 of the Sonoma County Code.
4. LAR-4 and LAR-5 are adjacent parcels; units calculations are based on the total area of the two parcels together

Figure 1 | Larkfield Service Area & Larkfield Sites



## 3.0 Methodology

This section describes the methodology used to assess the potential increase in water demand caused by the proposed rezoning. It also analyzes CAW's existing and proposed water supply for the Larkfield service area for average, single dry, and multiple dry year scenarios.

For this analysis, CAW's Internal 2019 Comprehensive Planning Study (Internal 2019 CPS) and Internal 2020 Urban Water Management Plan (Internal 2020 UWMP) were used. Both were developed as internal planning documents for the Larkfield service area. CAW was not required to submit the UWMP because the Larkfield service area does not provide over 3,000 acre-feet of water annually nor does it serve more than 3,000 urban connections.

### 3.1 Projected Water Demands for the Larkfield Sites

The Sites' buildout water demand was calculated based on the existing and proposed zoning designations. The buildout water demands were then compared to evaluate the total change in water demand associated with the rezoning of the Sites.

Water demand for residential lots was calculated by multiplying the estimated number of units by an assumed water use per unit value. Assumptions used for the water use per unit value were provided by CAW. Residential indoor use was expected to meet the state goal of 50 gallons per person per day. Residential outdoor use was based on a combination of historical demands, California use goals, census data, and various development guides from other water providers.

Water demand for non-residential lots was assumed to be 1,800 gallons per day per acre. This assumption was provided by CAW and is consistent with other water demand projections calculated by CAW.

The water demands for the buildout of the parcels using the existing and proposed zoning designations are summarized in **Table 2** and **Table 3**, respectively. Peaking factors from CAW's Internal 2019 CPS were applied to average day demand to estimate maximum day demand and peak hour demand.

Using the existing zone designations, the buildout annual demand for the Sites is estimated to be 0.027 million gallons per day (MGD). The buildout annual demand for the proposed zoning designations is estimated to be 0.088 MG. Therefore, the proposed rezoning for the Sites is estimated to increase the buildout water demand for the Larkfield service area by approximately 0.060 MGD.

Note that these demands do not include fire flow requirements. Fire flows are not considered a component of either use or supply and as such, are not addressed in this document.

**Table 2 | Existing Buildout Water Demand for Sites Area**

Zoning Description	Units	Acres	Water Use per Unit (gpd)	Water Use per Acre (gpd)	Average Day Demand (gpd)	Maximum Day Demand (gpd)	Peak Hour Demand (gpd)	Average Annual Demand (MGD)
Low-density Residential	7	1.51	375	-	2,625	6,038	9,056	0.003
Medium-density Residential	43	4.78	293	-	12,582	28,938	43,407	0.013
Planned Community	12	1.78	293 <sup>1</sup>	-	3,511	8,076	12,114	0.004
Limited Commercial	-	2.59	-	1,800 <sup>2</sup>	4,662	10,723	16,084	0.005
Administrative and Professional Office	-	2.18	-	1,800 <sup>2</sup>	3,924	9,025	13,538	0.004
<b>Total</b>	<b>62</b>	<b>12.84</b>			<b>27,304</b>	<b>62,799</b>	<b>94,199</b>	<b>0.027</b>

Notes:

1. Medium-density residential demand assumed.
2. A potable water use factor of 60% is applied to the assumed water use per acre of 3000 gallons per acre per day.

**Table 3 | Larkfield Proposed Water Demands**

Zoning Description	Units	Acres	Water Use per Unit (gpd)	Average Day Demand (gpd)	Maximum Day Demand (gpd)	Peak Hour Demand (gpd)	Average Annual Demand (MGD)
Medium Density	293	12.38	293	85,732	197,183	295,775	0.086
High Density	12	0.46	155	1,865	4,289	6,434	0.002
<b>Total</b>	<b>305</b>	<b>12.84</b>		<b>87,597</b>	<b>201,472</b>	<b>302,208</b>	<b>0.088</b>

Notes:

1. Medium-density residential demand assumed.
2. High-density residential demand assumed.

### 3.2 Existing and Projected Water Demand for the Larkfield Service Area

The Larkfield water system primarily serves residential and commercial customers. The historical demand for this service area is presented in **Table 4**. The Tubbs fire in 2017 caused significant damage to structures in the area and resulted in a decrease in water demand in 2018 and 2019. By 2020 the data shows that demand increased to pre-fire levels.

**Table 4 | Larkfield Historical Water Use**

Year	Residential (MGD)	Commercial (MGD)	Other (MGD)	Non revenue (MGD)	Total (MGD)
2011	0.510	0.260	0.008	0.052	0.830
2012	0.529	0.260	0.008	0.090	0.888
2013	0.389	0.211	0.003	0.071	0.674
2014	0.430	0.241	0.005	0.044	0.721
2015	0.381	0.219	0.011	0.049	0.660
2016	0.400	0.230	0.005	0.044	0.679
2017	0.416	0.238	0.016	0.096	0.767
2018	0.321	0.230	0.011	0.079	0.641
2019	0.362	0.247	0.008	0.055	0.671
2020	0.438	0.233	0.003	0.079	0.753

Recovery from the fire damage is continuing and CAW anticipates a full recovery by 2025. In its Internal 2020 UWMP, CAW stated that expected growth in this area after 2025 is minimal. However, the rezoning of the Sites may change that assumption. The future demand stated in CAW’s Internal 2020 UWMP is listed in **Table 5** alongside the additional demand caused by the rezoning of the Sites. The Sites’ additional potential demand is added to Larkfield’s planned future demand for each planning year because of the uncertainty of when the Sites could be developed.

**Table 5: | Larkfield Projected Water Demand (MGD)**

	2025	2030	2035	2040
Planned Future Demand	0.773	0.775	0.784	0.792
Additional Demand - Larkfield Sites	0.060	0.060	0.060	0.060
<b>Total Future Demand</b>	<b>0.833</b>	<b>0.836</b>	<b>0.844</b>	<b>0.852</b>

### 3.3 Existing and Projected Water Supply for the Larkfield Service Area

The Larkfield service area is primarily supplied by four active CAW groundwater wells, located in the Santa Rosa Valley Basin. The groundwater supply is augmented with wholesale water from Sonoma County Water Agency (SCWA). CAW has an interconnection and water supply agreement with the SCWA that expires in 2040. This agreement allows CAW to purchase up to an average of 0.8 million gallons per day (MGD) in any month and up to 700 acre-feet (228 million gallons) of



potable water per fiscal year. Additionally, CAW has an agreement with SCWA to purchase additional supply to meet peak demands, but this agreement expires in 2024 and it is unknown at this time if this agreement can be extended.

Historical supply for CAW’s Larkfield service area is shown in **Table 6**.

**Table 6 | Historical Larkfield Supply**

Source	Rate of Supply (MGD)				
	2016	2017	2018	2019	2020
SCWA	0.241	0.290	0.192	0.233	0.238
Groundwater Wells	0.438	0.479	0.449	0.438	0.512
<b>Total Supply</b>	<b>0.679</b>	<b>0.770</b>	<b>0.641</b>	<b>0.671</b>	<b>0.751</b>

Notes:

1. Provided from the Santa Rosa aqueduct.
2. Pumps from alluvial deposits and fractured rock.

The supply for the Larkfield service area is summarized in **Table 7**. The purchase agreement with SCWA is not guaranteed and is therefore not included in the safe yield.

**Table 7 | Larkfield Water Supplies**

Supply Type	Source	Available Drinking Water (MGD)	Safe Yield
Groundwater	Santa Rosa Valley Basin	1.389	1.389
Purchased Water <sup>1</sup>	Sonoma County Water Agency	0.625	0.000
<b>Larkfield Total</b>		<b>2.014</b>	<b>1.389</b>

Notes:

1. Safe Yield is defined here as reasonable supply in a dry period. Because water from SCWA is not guaranteed during a dry period, it is assumed to be zero.

### 3.4 Water Service Reliability for the Larkfield Service Area

The reliability of water supply to CAW’s Larkfield service area was determined by comparing projected water demand with the volume of water expected to be available in a normal year, a dry year, and five consecutive dry years. Groundwater supplies were assumed to be drought resistant; therefore, supplies were assumed to be similar in average years, single dry years, and consecutive dry years. To be conservative, only the firm capacity of CAW’s groundwater wells was used for the single-dry and consecutive dry years. Because the purchased supply from SCWA is not guaranteed, it was assumed that this source will not be available in dry and consecutive dry years.

Both annual demand and maximum month demand scenarios were reviewed as part of this analysis. The annual scenario assumed all wells are active. However, the maximum month scenario assumed that the largest well is inactive. A summary of water supply used for the normal, single-dry, and consecutive dry year scenarios is provided in **Table 8**.

**Table 8 | Available Supply for Various Supply Scenarios**

Year Type	Available Supplies if Year Type Repeats	
	Annual Scenario Rate Available (MGD) <sup>1</sup>	Max Month Scenario Rate Available (MGD) <sup>2</sup>
Normal Year	2.014	1.54
Single-Dry Year	1.389	0.74
Consecutive Dry Years 1 <sup>st</sup> – 5 <sup>th</sup>	1.389	0.74

Notes:

1. Rate available is total capacity of active wells. Purchased water from SCWA is assumed to be available only during normal year scenario.
2. Rate available for maximum month scenario is firm capacity, computed with the largest producing well offline. Purchased water from SCWA is assumed to be available only during normal year scenario.

In **Table 9**, CAW’s planned future annual demand for the Larkfield service area with the additional demand associated with rezoning the Larkfield Sites is compared to the supply conditions listed in **Table 8**.

**Table 9 | Larkfield Service Area’s Projected Water Supply vs Annual Demand**

Annual Demand (MGD)		2025	2030	2035	2040
<b>Normal Year</b>					
	Supply Totals	2.014	2.014	2.014	2.014
	Demand Totals	0.833	0.836	0.844	0.852
	<b>Difference</b>	<b>1.181</b>	<b>1.178</b>	<b>1.170</b>	<b>1.162</b>
<b>Single Dry Year</b>					
	Supply Totals	1.389	1.389	1.389	1.389
	Demand Totals	0.833	0.836	0.844	0.852
	<b>Difference</b>	<b>0.556</b>	<b>0.553</b>	<b>0.545</b>	<b>0.537</b>
<b>Consecutive Dry Years</b>					
1 <sup>st</sup> – 5 <sup>th</sup>	Supply Totals	1.389	1.389	1.389	1.389
	Demand Totals	0.833	0.836	0.844	0.852
	<b>Difference</b>	<b>0.556</b>	<b>0.553</b>	<b>0.545</b>	<b>0.537</b>

Projected maximum month demand for the Larkfield service area with the additional demand associated with rezoning the Larkfield Sites is compared to available supply for normal and dry years in **Table 10**. As shown in **Table 8**, CAW’s groundwater supply is considered as firm supply, computed with largest producing well offline for the maximum month scenario, and purchased water from SCWA is assumed to be unavailable in the dry year scenarios.

**Table 10 | Larkfield Service Area’s Projected Supply vs Maximum Month Demand**

Maximum Month Demand (MGD)		2025	2030	2035	2040
<b>Normal Year</b>					
	Supply Totals	1.54	1.54	1.54	1.54
	Demand Totals	1.15	1.16	1.17	1.18
	<b>Difference</b>	<b>0.39</b>	<b>0.38</b>	<b>0.37</b>	<b>0.36</b>
<b>Single Dry Year</b>					
	Supply Totals	0.74	0.74	0.74	0.74
	Demand Totals	1.15	1.16	1.17	1.18
	<b>Difference</b>	<b>-0.41</b>	<b>-0.42</b>	<b>-0.43</b>	<b>-0.44</b>
<b>Consecutive Dry Years</b>					
1 <sup>st</sup> – 5 <sup>th</sup>	Supply Totals	0.74	0.74	0.74	0.74
	Demand Totals	1.15	1.16	1.17	1.18
	<b>Difference</b>	<b>-0.41</b>	<b>-0.42</b>	<b>-0.43</b>	<b>-0.44</b>

### 3.5 Future Water Supply Projects for the Larkfield Service Area

As part of its Internal 2019 CPS, CAW identified a supply capital improvement project for the Larkfield service area that would construct an emergency supply connection with the neighboring City of Windsor. As this would be an emergency supply connection, the actual volume of water to be supplied is unknown.

An Integrated Water Supply Master Plan for the Larkfield service area is planned to be completed in 2024. The purpose of this study will be to determine possible supplemental sources and evaluate their implementation feasibility. The study may include exploration of groundwater and surface water sources, aquifer storage and recovery, and reuse. Potential supply sources may be collaborations with nearby water providers or regional water supply solutions. Considerations will be given to water quality, accessibility to the existing distribution system, and availability in dry and critical years. The study may also include field feasibility testing, coordination with local governments and water providers, and exploration of project funding opportunities. The outcome of the study will be a prioritized list of supply options including planning level cost estimates.

## 4.0 Comparison and Determination of Sufficient Supply

In this section the calculations and information provided in previous sections are analyzed in terms of the requirements stated in SB 610 and SB 221.

### 4.1 SB 610 Water Supply Assessment

The SB 610 assessment evaluates whether there is sufficient supply to meet the proposed projected demands in addition to all existing and planned future demands.

The increased water demand associated with the proposed rezoning of the Sites was calculated in **Section 3.1** to be approximately 0.060 MGD. When compared to the expected water supply during

normal, single dry, and consecutive dry years in **Section 3.4**, the analysis showed that the Larkfield service area has sufficient supply to meet these demands during normal, single dry, and consecutive dry year scenarios.

However, the Larkfield service area does not have sufficient supply to meet the maximum month demand with the largest source out of service. It's worth noting that without the additional demand from the Larkfield Sites rezoning, the analysis still shows a supply deficit during the single dry and consecutive dry year scenarios.

In conclusion, CAW has sufficient supply for the increased water demand associated with the Larkfield Sites rezoning. However, CAW cannot guarantee sufficient supply during maximum month demand scenarios during dry year scenarios without acquiring additional water sources.

#### 4.2 SB 221 Water Supply Verification

Written verification is required by SB 221 stating the availability of sufficient water supply from the applicable public water system. The SB 610 assessment presented in **Section 4.1** of this memorandum is sufficient to meet most of the requirements of SB 221. The additional requirements to comply with SB 221 are addressed in this section.

The historical record of water supply availability for the last 20 years must be considered when verifying the sufficiency of the water supply (Government Code section 66473.7 subdivision (a) (2)). Historical supply for the Larkfield service area is summarized in **Table 6**, and a full list of supply for the past 20 years is included in **Table 11**.

**Table 11 | 20-Year History of Larkfield Service Area Water Supply**

Year	System Delivery (MGD)
2002	1.170
2003	1.170
2004	1.241
2005	1.090
2006	1.049
2007	1.060
2008	1.079
2009	0.910
2010	0.819
2011	0.830
2012	0.860
2013	0.849
2014	0.721
2015	0.660
2016	0.679
2017	0.770

Year	System Delivery (MGD)
2018	0.641
2019	0.671
2020	0.751
2021	0.721

The ability to meet the Government Code 66473.7 (2) (B) requirement for an “urban water shortage contingency analysis prepared pursuant to Section 10632 of the water code” must be assessed. The CAW Water Shortage Contingency Plan complies with Government Code section 10632 and will apply to the Sites.

Supply reduction for specific water use sector per the resolution adopting water shortage contingency plans must not conflict with Water Code Section 354. Section 354 addresses ensuring that the governing body of CAW allocates and sets aside the amount of water which will be necessary to supply water needed for domestic use, sanitation, and fire protection uses. CAW prioritizes these needs over other uses, and for purposes of this verification, is considered to be in accordance with Water Code Section 354.

The amount of water that can be reasonably relied upon from specified supply projects must be considered in determining sufficiency. These are limited in SB 221 specifically to other water supply projects including conjunctive use, reclaimed water, water conservation, and water transfers. Additional supply projects for the Larkfield service area are described in **Section 3.5**.

Water supply verification must be based on substantial evidence, which Government code section 66473.7(c) clarifies as urban water management plans or assessments. The water supply projections utilized in the SB 610 assessment are based on the supply projections shown in CAW’s Internal 2020 UWMP.

Government Code Section 66473.7 subdivision (j) states that the verification must be consistent with the water supplier’s obligation to grant priority for water to low-income housing projects. Subdivision (g) of the same section requires a description of the impacts to agricultural and industrial uses from supplying water to the proposed subdivision. There are no proposed low-income housing projects for which provision of water resources or services by CAW would be precluded if water is provided to the Sites. Similarly, no impacts on the availability of water resources for agricultural and industrial uses within the CAW service area boundary are expected to result from CAW providing water to the Sites.

## 5.0 Recommendations

Based on the results of the SB 610 water supply assessment and SB 221 verification of the availability of sufficient water supply presented herein, both of which are based on substantial evidence, CAW has sufficient water supply to serve the proposed rezoning of the Larkfield Sites. However, CAW cannot guarantee sufficient supply during maximum month demand scenarios during dry year scenarios without acquiring additional water sources. CAW has insufficient supply

to meet existing maximum month demand with the largest well out of service during dry year scenarios. Therefore, it cannot support any increase in demand without an increase in available supply during dry year scenarios.

The following recommendations are offered for consideration.

1. Upon receipt of the final version of this Technical Memorandum, CAW should issue its concurrence with the findings stated wherein.
2. Upon receipt of evidence that the CAW has approved the water supply assessment, Sonoma County should include the assessment and any additional water supply information in the CEQA document.

# Appendix WSS

---

Water and Sewer Study

# Sonoma County Rezoning Sites for Housing Project Water and Sewer Study

*Prepared for:*



*and*



*Prepared by:*



August 15, 2022



---

## Contents

---

1.0	Introduction and Background.....	1
2.0	Project Site Locations.....	2
3.0	Water and Sewer Agencies.....	6
4.0	Existing Infrastructure.....	7
5.0	Water and Sewer Overview.....	10
5.1	Water Demand.....	11
5.2	Sewer Generation.....	14
6.0	Water System Analysis.....	16
6.1	Water System Results.....	19
7.0	Sewer System Analysis.....	22
7.1	Sewer System Results.....	25
8.0	Results.....	29

---

## Tables

---

Table 2-1.	Existing and Proposed Population.....	2
Table 3-1.	Water and Sewer Agencies.....	6
Table 3-2.	Agency Water Supply.....	7
Table 3-3.	Agency Wastewater Treatment Facilities.....	7
Table 4-1:	Water and Sewer Infrastructure by Parcel.....	8
Table 5-1.	Water Demand for Proposed Build Out.....	12
Table 5-2.	Increase in Water Demand by USA.....	14
Table 5-3.	Sewage Generation for Proposed Build Out.....	14
Table 5-4.	Increase in Sewage Generation by USA.....	15
Table 6-1.	Water Category Results.....	20
Table 7-1.	Sewer Category Results.....	26
Table 8-1.	Full Categorical Results for Each Site.....	29

---

## Figures

---

Figure 2-1.	Sonoma County Housing Sites for Rezoning (source: Rincon Consultants).....	5
-------------	--	---

---

## Appendices

---

Appendix A:	Maps of Sites Under Consideration by USA
Appendix B:	Land Use Summary of Sites Under Consideration
Appendix C:	Agency Meeting Schedule
Appendix D:	Reference Documents

## 1.0 Introduction and Background

Like many counties throughout California, Sonoma County (County) is known for its high cost of living and lack of affordable, available housing. New construction in the County has not kept up with housing demand over the last half decade, and the 2017 wildfires destroyed over 5,000 housing units Countywide, exacerbating an already dire housing crisis.

The Sonoma County Permit and Resource Management Department (Permit Sonoma) is preparing a program Environmental Impact Report (EIR) for the rezoning of selected sites throughout the County for housing.

Proper location is an important consideration for new housing in the unincorporated County, as there has been long-standing Countywide concern to avoid sprawl and protect open space. The County is largely rural, with limited urban areas. There are strong General Plan policies that protect designated Community Separators and facilitate city- and community- centered growth, voter-approved Urban Growth Boundaries, and General Plan-designated Urban Service Areas (USAs) where public sewer and water are available and higher densities of housing could be built.

This project will identify sites to be added to the County's Housing Element site inventory to comply with State law and will implement current General Plan Policies and Programs that require the County to identify urban sites near jobs and transit which may appropriately accommodate additional housing. It will also identify appropriate sites on which to place the Workforce Housing Combining Zone, which would allow the development of jobs and/or housing on the same site or within walking distance from one another.

In 2018, the County asked the public for help identifying sites and received over 100 potential sites which was narrowed down to 59 based on the following four criteria:

1. Site must be located in the unincorporated County
2. Site must be located within an established USA where public water and sewer service is available
3. Site must not be located within a Community Separator
4. If a site is near an incorporated city, it must not be located outside of a city's Urban Growth Boundary (UGB)

Eight of the sites to be evaluated are already included in the County's Housing Element site inventory at a lower density but recent changes in State law give increased scrutiny to the continuing identification of sites already in inventory. Increasing the zoning densities for these sites may allow them to remain in inventory. By the end of the project, up to 59 urban sites in designated USAs throughout unincorporated Sonoma for by-right, medium density housing (no land use approvals for the development of medium- density housing would be required).

For the purposes of this environmental study, sites analyzed for rezoning to R2 (medium-density residential) with a base of 10 dwelling units (DU) per acre were assumed to increase to 20 DU per acre, the maximum allowable build out potential utilizing the County's 100% density bonus program. Sites analyzed for Workforce Housing Combining Zones are assumed to be allowed a density of 24 DU per acre which is the maximum allowed in these zones.

The purpose of this Water and Sewer Study (Study) is to conduct a high-level investigation to identify the water and sewer agencies that provide service to these potential sites, determine if water and sewer infrastructure exist adjacent to the proposed project sites, calculate the additional water demand and sewage generation from the increased housing density, and investigate if capacity exists within the existing systems to accommodate the proposed projects.

## 2.0 Project Site Locations

In late 2018, the County asked for the public’s help in identifying potential sites for rezoning, and over 100 sites were nominated. County staff evaluated all nominated sites to determine if they met the basic eligibility criteria and narrowed it down to 59 sites. Some sites that will be evaluated were included in a prior housing element, but the County proposes to include them in this analysis so that the potential for cumulative impacts can be analyzed. The 59 sites proposed for re-zoning are shown in **Figure 2-1** below (provided by Rincon Consultants). The environmental review process will further refine the sites with the potential for rezoning. The 59 sites are located in the following USAs of:

Geyserville (GEY) 4	Guerneville (GUE) 4	Larkfield (LAR) 8
Forestville (FOR) 6	Graton (GRA) 5	South Santa Rosa (SAN) 10
Glen Ellen (GLE) 2	Agua Caliente (AGU) 3	Penngrove (PEN) 9
Petaluma (PET) 4	Sonoma (SON) 4	

The 59 sites total approximately 164-acres of land. The existing zoning for each parcel was evaluated and proposed to be re-zoned in order to increase the density of each parcel. Each of the 59 sites was assigned a site ID based on their USA and site number within the USA. Based upon the parcel area, current land use zoning designation, and the average Sonoma County household of 2.6 persons per dwelling unit (per the latest census), a population density based on the existing zoning was determined to be approximately 960 persons. With the proposed rezoning for each parcel, the maximum build-out population increase to approximately 8,656 persons, or an increase of 7,696 persons. The proposed re-zoning of the 59 parcels will result in approximately 3,329 dwelling units.

**Table 2-1** below summarizes the existing population based on the current zone, the proposed population based on the re-zoning, and the increase in population for each of the potential sites.

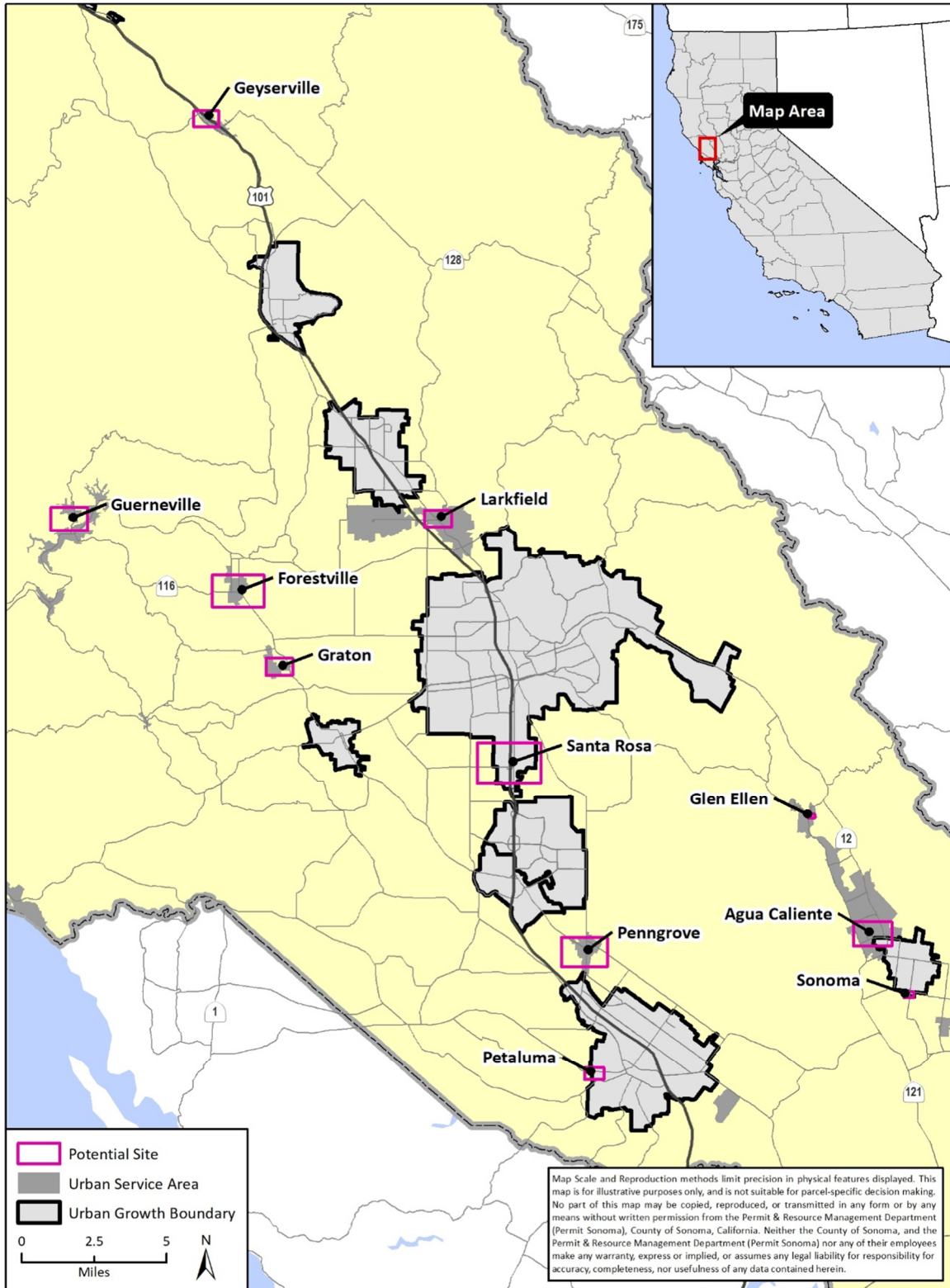
**Table 2-1. Existing and Proposed Population**

Site ID	Site Area (ac)	Existing Max Population	Proposed Max Population	Population Change
AGU-1	1.3	3	70	68
AGU-2	6.6	18	343	325
AGU-3	3.2	42	166	125
FOR-1	2.9	120	182	62
FOR-2	14.1	18	736	718
FOR-3	1.7	8	86	78
FOR-4	3.5	5	185	179
FOR-5	2.9	16	151	135
FOR-6	5.0	0	312	312
GEY-1	5.1	213	320	107
GEY-2	1.6	21	86	65
GEY-3	1.1	13	57	44
GEY-4	1.3	16	68	52

Site ID	Site Area (ac)	Existing Max Population	Proposed Max Population	Population Change
GLE-1	0.8	3	49	47
GLE-2	0.1	3	8	5
GRA-1	1.1	16	60	44
GRA-2	3.0	0	185	185
GRA-3	1.1	3	57	55
GRA-4	1.8	3	94	91
GRA-5	1.3	3	70	68
GUE-1	1.5	16	78	62
GUE-2	4.0	5	208	203
GUE-3	2.1	21	107	86
GUE-4	5.3	8	273	265
LAR-1	4.4	3	252	250
LAR-2	0.7	0	42	42
LAR-3	0.7	26	36	10
LAR-4	0.3	10	16	5
LAR-5	4.5	187	257	70
LAR-6	0.6	0	31	31
LAR-7	2.0	26	117	91
LAR-8	0.5	0	29	29
PEN-1	0.1	0	3	3
PEN-2	1.0	3	55	52
PEN-3	0.2	0	10	10
PEN-4	1.7	5	91	86
PEN-5	0.3	3	21	18
PEN-6	2.0	5	104	99
PEN-7	5.4	47	278	231
PEN-8	0.6	0	42	42
PEN-9	0.3	0	21	21
PET-1	2.0	3	101	99
PET-2	1.4	3	70	68
PET-3	4.9	3	169	166
PET-4	1.9	3	101	99
SAN-1	3.7	3	192	190

Site ID	Site Area (ac)	Existing Max Population	Proposed Max Population	Population Change
SAN-2	8.3	0	520	520
SAN-3	4.0	3	208	205
SAN-4	6.2	3	387	385
SAN-5	3.4	3	174	172
SAN-6	3.0	0	190	190
SAN-7	3.0	0	187	187
SAN-8	1.0	3	52	49
SAN-9	6.6	0	413	413
SAN-10	13.2	8	333	325
SON-1	1.0	0	49	49
SON-2	1.0	0	52	52
SON-3	1.0	3	52	49
SON-4	1.0	3	49	47
<b>TOTAL<sup>1</sup></b>	<b>164.3</b>	<b>930</b>	<b>8,655</b>	<b>7,725</b>

<sup>1</sup> Note: Totals may not sum exactly due to rounding.



Source: Modified from data obtained with permission from the County of Sonoma, Permit & Resource Management Department (Permit Sonoma).  
 Data and/or analysis depicted may be altered from the original Permit Sonoma dataset source therefore not representative of Permit Sonoma data; Esri.

**Figure 2-1. Sonoma County Housing Sites for Rezoning (source: Rincon Consultants)**

**Appendix A** provides larger scaled maps of the individual USAs identifying the 59 parcels that were considered for this Study. **Appendix B** provides individual parcel information in a tabular form.

### 3.0 Water and Sewer Agencies

The Sonoma County Water Agency (Sonoma Water) provides an array of services throughout Sonoma County, including, but not limited to, drinking water, distribution of recycled water and wastewater treatment.

Sonoma Water manages and maintains a water transmission system that provides naturally filtered Russian River water to nine cities and special districts that in turn delivers drinking water to more than 600,000 residents in portions of Sonoma and Marin counties. Sonoma Water provides wholesale drinking water to the following cities and special districts: City of Cotati, Marin Municipal Water District, North Marin Water District, City of Petaluma, City of Rohnert Park, City of Santa Rosa, City of Sonoma, Valley of the Moon Water District, and the Town of Windsor.

In 1995 Sonoma Water assumed responsibility from the County of Sonoma for managing the county sanitation zones and districts, which provide wastewater collection/treatment, and recycled water distribution/disposal services for approximately 7,000 residences and businesses. The zones include Airport/Larkfield/Wikiup, Geyserville, Penngrove and Sea Ranch. The sanitation districts include the Occidental, Russian River, Sonoma Valley, and South Park County Sanitation Districts.

There are multiple water and sewer agencies responsible for providing service to the proposed project sites. The agencies are listed in **Table 3-1**. In order to obtain information about each system, documents were obtained from the agency’s website (if available), and each agency was contacted via phone call and email. In a few cases, site visits were made to obtain system information. **Appendix C** summarizes the reference documents obtained for this Study and the source used to retrieve them.

**Table 3-1. Water and Sewer Agencies**

Urban Service Area	Water Service Provider	Sewer Service Provider
Agua Caliente	Valley of the Moon Water District	Sonoma Valley County Sanitation District (Sonoma Water)
Glen Ellen		
Sonoma		
Forestville	Forestville Water District	Forestville Water District
Geyserville	California American Water - Geyserville	Geyserville Sanitation Zone (Sonoma Water)
Graton	Individually Owned Wells	Graton Community Services District
Guerneville	Sweetwater Springs Water District/California Water Service – Armstrong Valley	Russian River County Sanitation District (Sonoma Water)
Larkfield	California American Water – Larkfield	Airport/Larkfield/Wikiup Sanitation Zone (Sonoma Water)
Penngrove	Penngrove/Kenwood Water Company	Penngrove Sanitation Zone (Sonoma Water)
Petaluma	City of Petaluma	City of Petaluma
Santa Rosa	City of Santa Rosa	City of Santa Rosa and South Park County Sanitation District (Sonoma Water)

**Table 3-2** summarizes the water supply source(s) for each agency.

**Table 3-2. Agency Water Supply**

Agency	Water Source
Valley of the Moon Water District	Sonoma Water, Local Wells
City of Sonoma	Sonoma Water, Local Wells
Forestville Water District	Sonoma Water
California American Water – Geyserville	Unknown <sup>[1]</sup>
California American Water – Larkfield	Unknown <sup>[1]</sup>
California Water Service –Armstrong Valley	Local Wells
Penngrove/Kenwood Water Company	Sonoma Water
City of Petaluma	Sonoma Water
City of Santa Rosa	Sonoma Water

[1] Information was not provided by the agency

**Table 3-3** identifies where each agency sends its sewage to be treated.

**Table 3-3. Agency Wastewater Treatment Facilities**

Agency	Treatment Facility
Sonoma Valley County Sanitation District	3.0 MGD Laguna Treatment Plant (Tertiary)
Forestville Water District	District’s Wastewater Treatment Reclamation and Disposal Plant
Geyserville Sanitation Zone	92,000 GPD WWTP (Secondary)
Graton Community Services District	GCSD (Ross Lane) WWTP
Russian River County Sanitation District	710,000 GPD WWTP (Tertiary)
Airport/Larkfield/Wikiup Sanitation Zone	900,000 GPD WWTP (Tertiary)
Penngrove Sanitation Zone	“Routed to City of Petaluma”
City of Petaluma	6.7 MGD Ellis Creek Water Recycling Facility (Tertiary)
South Park County Sanitation District	MGD Laguna Sub-Regional Treatment Plant (Tertiary)
City of Santa Rosa	

## 4.0 Existing Infrastructure

An initial task of this analysis is to determine if water and sewer infrastructure exists directly adjacent to the parcels proposed for rezoning using publicly available agency documents, GIS files, atlas maps and discussions with agency staff (if available). For the purposes of the analysis, directly adjacent is taken to mean that infrastructure exists either across the frontage of the property (such as in a road) or extending into the property. The results of the infrastructure analysis are summarized in **Table 4-1**.



**Table 4-1: Water and Sewer Infrastructure by Parcel**

Site ID	Adjacent Water Service	Adjacent Water Pipes	Adjacent Sewer Service	Adjacent Sewer Pipe
AGU-1	Yes	6" AC	Yes	21" RCP
AGU-2	Yes	6" PVC	Yes	21" RCP
AGU-3	Yes	6" AC	Yes	6"/8" VCP
		6" C-900		
		8" AC		
GLE-1	Yes	6" AC	Yes	6" AC
		8" AC		6"/16" AC
GLE-2	Yes	6"/8" AC	Yes	6" AC
FOR-1	Yes	8" AC	No	
FOR-2	Yes	6" AC on four sides	No	
FOR-3	Yes	8" AC	Yes	8" AC
FOR-4	No		Yes	8" AC on two sides
FOR-5	Yes	8" AC	Yes	8" AC
		6" AC		
FOR-6	Yes	8" AC	No	
GRA-1	No		Yes	6" on two sides
GRA-2	No		Yes	6"/12"
GRA-3	No		Yes	6"
GRA-4	No		No	
GRA-5	No		Yes	6"
PET-1	Yes	8" AC	No	
PET-2	Yes	8" AC	Yes	6" PVC
PET 3 C1	Yes	8" AC	Yes	6" PVC and manhole
PET-3 AR				
PET-4	Yes	8" AC	Yes	6" PVC
SAN-1	No		Yes	8" PVC
SAN-2	Yes	12" PVC on smallest side	Yes	27" RCP
SAN-3	No		Yes	8" PVC
SAN-4	Yes	12" DI	Yes	16" CP

Site ID	Adjacent Water Service	Adjacent Water Pipes	Adjacent Sewer Service	Adjacent Sewer Pipes
SAN-5	No		Yes	8" PVC
SAN-6	Yes	12" AC	Yes	10" AC
SAN-7	Yes	12" AC	Yes	10" AC
SAN-8	No		Yes	8" PVC
SAN-9	Yes	8" PVC	Yes	15" PVC
		16" DI		
SAN-10 M1	Yes	12" PVC	No	
SAN-10 RR	Yes		No	
SON-1	No		No	
SON-2	No		No	
SON-3	No		No	
SON-4	No		No	
GUE-1	No		Yes	6" AB
GUE-2	No		Yes	6" AB
GUE-3	Yes	2" PVC	Yes	6" PVC on two sides
		4" PVC		6" AB
GUE-4	Yes	4" PVC	Yes	6" AB
PEN-1	Yes	6"	Yes	8" AC
PEN-2	Yes	6"	No	
PEN-3	Yes	6"	Yes	8" AC
PEN-4	Yes	6"	No	
PEN-5	Yes	6"/8"	Yes	8" AC
PEN-6	Yes	6"/8"	Yes	6" AC
PEN-7 AH	Yes	6"/8"	Yes	6" AC
PEN-7 RR B6				
PEN-8	Yes	6"	Yes	6" AC
PEN-9	Yes	6"	No	
LAR-1 <sup>1</sup>	Yes	NE and NW Boundary	Yes	21" RCP
				8" PVC
				6" AC
LAR-2 <sup>1</sup>	Yes	SE Boundary	Yes	8" PVC
LAR-3 <sup>1</sup>	Yes	S and NE Boundary	Yes	8" DI
LAR-4 <sup>1</sup>	Yes	S Boundary	Yes	21" RC
LAR-5 <sup>1</sup>	Yes	S Boundary	Yes	8" PVC
				21" RC
LAR-6 <sup>1</sup>	Yes	SE Boundary	Yes	8" PVC

Site ID	Adjacent Water Service	Adjacent Water Pipes	Adjacent Sewer Service	Adjacent Sewer Pipes
LAR-7 <sup>1</sup>	Yes	NE Boundary	No	
LAR-8 <sup>1</sup>	Yes	SW Boundary	Yes	21" RCP
GEY-1 <sup>1</sup>	Yes	NE Boundary	No	
GEY-2 <sup>1</sup>	Yes	NE Boundary	Yes	6" AC
GEY-3 <sup>1</sup>	Yes	NE Boundary	Yes	6" AC
GEY-4 <sup>1</sup>	Yes	NE Boundary	Yes	6" AC

There were several water agencies, denoted as “unavailable” in Table 4-1 above, where existing infrastructure information was not available or provided. For these sites, Google Earth Pro was used to identify fire hydrants, valve covers, and manhole covers in the area which would indicate existing water and sewer service nearby. A site visit was also performed to investigate the availability of services through a surface investigation.

After reviewing the available information to determine the existing infrastructure adjacent to the proposed parcel, discussions were held with most agencies to understand their existing systems in greater detail. The information gathered includes, but is not limited to infrastructure condition, excess capacity, supply and storage availability, and system specific issues. This information was used to place each site into one of three categories as defined below:

1. Category 1 – Adequate as is to support rezoning
2. Category 2 – Adequate, however some improvements are likely
3. Category 3 – Inadequate as is, requires significant improvements

A Category 1 site has both water and sewer infrastructure directly adjacent to the parcel, both the water and sewer systems have available capacity, and there are no supply or treatment deficiencies. These sites can be re-developed with minimal to no infrastructure improvements required.

For a Category 2 site, there is both water and sewer infrastructure within the general vicinity of the site, however the infrastructure may need to be extended or upsized. Category 2 sites may have system deficiencies identified, however plans to mitigate the deficiency are planned by the agency.

Category 3 sites will have more extensive concerns, such as no water and/or sewer service in the vicinity of the parcel or have supply or treatment deficiencies that cannot be easily mitigated. These parcels will require significant improvements or actions to provide water and/or sewer service.

For each parcel that is either Category 2 or 3, an initial list of action items has been identified that would enable the site to become Category 1.

It is noted that for each parcel identified in this study, the individual agencies will still require the projects to go through the typical development application process, which likely will require a more detailed water and sewer study once the development plans have been determined. However, the specifics of what will be required is up to the agency who has jurisdiction and will be subject to their approval.

## 5.0 Water and Sewer Overview

The following section will provide an overview of the water and sewer systems that are applicable to parcels in question. Each agency was contacted to set up a (virtual) meeting to verify the existing conditions present for each site and understand if there are other concerns about serving each parcel. All but two agencies, California American Water (Larkfield and Geyserville) and Penngrove/Kenwood Water Company, made

<sup>1</sup> CalAm did not provide material or diameter information.

themselves available for these discussions. Included in **Appendix C** is the list of meetings held, including the attendees and dates they occurred.

### **Regional Water Supply**

Sonoma County Water Agency (Sonoma Water) obtains the majority of its water from the Russian River which is stored in two reservoirs, Lake Mendocino and Lake Sonoma. Lake Mendocino is formed by Coyote Dam, which provides a total storage capacity of 118,000 acre-feet/year and a water supply pool of 70,000 acre-feet/year, although Sonoma Water has the rights to store up to 122,500 acre-feet/year of water in Lake Mendocino. Warm Springs Dam forms Lake Sonoma, which has a total storage capacity of 381,000 acre-feet/year with a water supply pool of 245,000 acre-feet/year.

Sonoma Water has the rights to divert or redivert up to 180 cubic feet per second (cfs) of water from the Russian River, with a limit of 75,000 acre-feet/year. There are six collector wells adjacent to the Russian River. Collectors 1 and 2 were constructed in the late 1950's and are located near the Wohler Bridge. Collectors 3, 4 and 5 were constructed between 1975 and 1985 and are located near Mirabel Park. Construction of Sonoma Water's newest collector well, Collector 6, was completed in the spring of 2006. Groundwater is extracted by each collector well from the alluvial aquifer adjacent to and beneath the Russian River.

Sonoma Water operates an inflatable dam on the Russian River in the Mirabel area to increase production capacity during peak demand months. Operation of the inflatable dam increases production capacity in two ways. First, surface water immediately behind the dam can be diverted to a series of infiltration ponds that are constructed adjacent to the three Mirabel collector wells. Second, infiltration to the underlying aquifer behind the dam is significantly improved by increasing the recharge area from the river.

As a stand-by water source, seven vertical wells were constructed in the late 1990's near the Mirabel collectors, providing 7 to 10 million gallons per day (mgd) of back-up capacity. Sonoma Water operates three groundwater wells in the Santa Rosa Plain. These wells pump groundwater from several hundred feet below the ground surface and are capable of providing up to 7 million gallons per day.

Per the 2015 Sonoma Water Urban Water Management Plan (UWMP), Sonoma Water has adequate water supply to meet the normal year projected water demands through Year 2040. The Year 2040 normal water demand is projected to be 75,987 acre-feet/year, with the regional water supplies projected to exceed 110,000 acre-feet/year.

### **Sewer Treatment**

Most of the Sonoma County area receives sewer service through subsidiaries of Sonoma Water. There are eight different districts/zones that Sonoma Water manages, six of which have parcels included in this study. Those zones/districts are: Geyserville Sanitation Zone, Russian River County Sanitation District, Sonoma Valley County Sanitation District, South Park County Sanitation District (which routes its wastewater to Santa Rosa Sub-Regional Treatment Plant), Airport/Larkfield/Wikiup Sanitation Zone, and Penngrove Sanitation Zone. Each of the districts have their own wastewater treatment plant, except for the Penngrove Sanitation Zone which routes its wastewater to the City of Petaluma.

In addition to the sanitation districts, there are four other sewer agencies that serve parcels included in this analysis: Graton Community Services District, Forestville Water District, the City of Petaluma, and the City of Santa Rosa. Each of these own and operate their own wastewater treatment facility.

## **5.1 Water Demand**

The projected increase in water demand was calculated for each site using a population-based approach. The proposed population increase for each site was multiplied by the water demand factors set by the County's regional compliance target (Senate Bill X7-7). **Table 5-1** below summarizes the current water demand requirement and the anticipated increase in demand for each parcel being analyzed.

**Table 5-1. Water Demand for Proposed Build Out**

Site ID	Exist. Max Population (per)	Exist. Average Day Demand (gpd)	Prop. Max Population (per)	Prop. Average Day Demand (gpd)	Prop. Average Day Demand (AFY)	Demand Increase (AFY)
AGU-1	3	372	70	8,680	9.86	9.45
AGU-2	18	2,232	343	42,532	47.65	45.1
AGU-3	42	5,208	166	20,584	23.2	17.4
GLE-1	3	372	49	6,076	6.95	6.5
GLE-2	3	372	8	992	1.11	0.7
GRA-1	16	0	60	8,088	6.64	6.6
GRA-2	0	0	185	24,938	27.9	27.9
GRA-3	3	0	57	7,684	8.3	8.3
GRA-4	3	0	94	12,671	13.7	13.7
GRA-5	3	0	70	9,436	10.3	10.3
PET-1	3	423	101	14,382	16.1	15.6
PET-2	3	423	70	10,011	11.2	10.7
PET-3	3	423	169	23,829	26.7	26.2
PET-4	3	423	101	14,382	16.1	15.6
SAN-1	3	378	192	24,318	27.2	26.8
SAN-2	0	0	520	65,520	73.4	73.4
SAN-3	3	378	208	26,208	29.4	28.9
SAN-4	3	378	387	48,762	54.77	54.77
SAN-5	3	378	174	22,050	24.7	24.3
SAN-6	0	0	190	23,940	26.8	26.8
SAN-7	0	0	187	23,562	26.4	26.4
SAN-8	3	378	52	6,552	7.3	6.9
SAN-9	0	0	413	52,038	58.3	58.3
SAN-10	8	1,008	333	41,958	47	45.9
FOR-1	120	16,200	182	24,570	27.5	9.4
FOR-2	18	2,430	736	99,260	111.3	108.6
FOR-3	8	1,080	86	11,094	13.01	11.8
FOR-4	5	675	185	23,865	27.8	27.07
FOR-5	16	2,160	151	19,479	22.8	20.4
FOR-6	0	0	312	42,120	47.2	47.2
SON-1	0	0	49	8,832	10	10
SON-2	0	0	52	9,360	10	10
SON-3	3	540	52	9,360	10	9.88
SON-4	3	540	49	9,000	10	9.48
LAR-1	3	405	252	33,964	38	37.8
LAR-2	0	0	42	5,661	6.3	6.3
LAR-3	26	3,510	36	4,852	5.4	1.5

Site ID	Exist. Max Population (per)	Exist. Average Day Demand (gpd)	Prop. Max Population (per)	Prop. Average Day Demand (gpd)	Prop. Average Day Demand (AFY)	Demand Increase (AFY)
LAR-4	10	1,350	16	2,156	2.3	0.8
LAR-5	187	25,245	257	34,638	38.9	10.6
LAR-6	0	0	31	4,178	4.7	4.7
LAR-7	26	3,510	117	15,795	17.7	13.8
LAR-8	0	0	29	3,909	4.4	4.4
GEY-1	213	28,755	320	43,200	48.4	16.2
GEY-2	21	2,835	86	11,591	13	9.8
GEY-3	13	1,755	57	7,682	8.6	6.65
GEY-4	16	2,160	68	9,165	10.3	7.9
GUE-1	16	2,156	78	10,513	11.8	9.4
GUE-2	5	673	208	28,034	31.5	30.7
GUE-3	21	2,830	107	14,421	16.2	13
GUE-4	8	1,080	273	36,855	41.3	40.1
PEN-1	0	0	3	404	0.5	0.5
PEN-2	3	405	55	7,425	8	7.9
PEN-3	0	0	10	1,350	2.0	2
PEN-4	5	675	91	12,285	14	13
PEN-5	3	405	21	2,835	3	2.7
PEN-6	5	675	104	14,017	15.7	14.97
PEN-7	47	3,384	278	37,468	22.4	18.63
PEN-8	0	0	42	5,661	3.39	3.39
PEN-9	0	0	21	1,512	1.7	1.7
<b>TOTAL</b>	<b>930</b>	<b>118,579</b>	<b>8,655</b>	<b>1,145,704</b>	<b>1,260</b>	<b>1,130</b>

**Table 5-2** below summarizes the increase in water demand for each USA assuming that all parcels under consideration are developed.

**Table 5-2. Increase in Water Demand by USA**

Urban Service Area	Water Demand Increase (AFY)	Water Service Provider
Agua Caliente	72.0	Valley of the Moon Water District
Glen Ellen	7.2	
Sonoma	39.4	City of Sonoma
Santa Rosa	373.57	City of Santa Rosa
Forestville	224.49	Forestville Water District
Larkfield	79.9	California American Water - Larkfield
Graton	66.8	Property Wells
Geyserville	40.55	California American Water - Geyserville
Guerneville	93.2	California Water Service Company –Armstrong Valley
Penngrove	64.8	Penngrove/Kenwood Water Company
Petaluma	68.1	City of Petaluma
<b>TOTAL</b>	<b>1,130</b>	

## 5.2 Sewer Generation

Sewer generation was calculated using a population-based approach as well, but the sewage generation and peaking factors came from the County’s development guidelines. **Table 5-3** below summarizes the resulting sewage generation for the proposed project sites.

**Table 5-3. Sewage Generation for Proposed Build Out**

Site ID	Exist. Max Population (per)	Existing Avg. Sewer Generation (gpd)	Prop. Max Population (per)	Proposed Avg. Sewer Generation (gpd)	Increase in Avg. Sewer Generation (gpd)	Peaking Factor	Increase in Peak Hour Generation (gpd)
AGU-1	3	231	70	5,462	5,231	1.94	10,148
AGU-2	18	1,385	343	26,385	25,000		48,500
AGU-3	42	3,231	166	12,846	9,615		18,654
GLE-1	3	231	49	3,846	3,615		7,014
GLE-2	3	231	8	615	385		746
GRA-1	16	1,214	60	4,551	3,338	2.24	7,476
GRA-2	0	0.0	185	14,033	14,033		31,434
GRA-3	3	228	57	4,400	4,172		9,345
GRA-4	3	228	94	7,130	6,903		15,462
GRA-5	3	228	70	5,386	5,158		11,554
PET-1	3	228	101	7,737	7,510	2.24	16,821
PET-2	3	228	70	5,386	5,158		11,554
PET-3	3	228	169	12,819	12,592		28,205
PET-4	3	228	101	7,737	7,510		16,821
SAN-1	3	269	192	17,296	17,027	2.24	38,140

Site ID	Exist. Max Population (per)	Existing Avg. Sewer Generation (gpd)	Prop. Max Population (per)	Proposed Avg. Sewer Generation (gpd)	Increase in Avg. Sewer Generation (gpd)	Peaking Factor	Increase in Peak Hour Generation (gpd)
SAN-2	0	0.0	520	46,600	46,600	2.24	104,384
SAN-3	3	269	208	18,640	18,371		41,151
SAN-4	3	269	387	34,771	34,502		77,284
SAN-5	3	269	174	15,683	15,414		34,527
SAN-6	0	0.0	190	17,027	17,027		38,140
SAN-7	0	0.0	187	16,758	16,758		37,538
SAN-8	3	269	52	4,660	4,391		9,836
SAN-9	0	0.0	413	37,011	37,011		82,905
SAN-10	8	717	333	29,842	29,125		65,240
FOR-1	120	9,102	182	13,805	4,703		2.42
FOR-2	18	1,365	736	55,828	54,463	131,801	
FOR-3	8	607	86	6,523	5,917	14,318	
FOR-4	5	379	185	13,957	13,578	32,858	
FOR-5	16	1,214	151	11,454	10,240	24,781	
FOR-6	0	0.0	312	23,666	23,666	57,273	
SON-1	0	0.0	49	3,769	3,769	1.94	7,312
SON-2	0	0.0	52	4,000	4,000		7,760
SON-3	3	231	52	4,000	3,769		7,312
SON-4	3	231	49	3,846	3,615		7,014
LAR-1	3	336	252	28,336	28,000	2.82	78,960
LAR-2	0	0.0	42	4,704	4,704		13,265
LAR-3	26	2,912	36	4,032	1,120		3,158
LAR-4	10	1,120	16	1,680	560		1,579
LAR-5	187	20,944	257	28,784	7,840		22,109
LAR-6	0	0.0	31	3,472	3,472		9,791
LAR-7	26	2,912	117	13,104	10,192		28,741
LAR-8	0	0.0	29	3,248	3,248		9,159
GEY-1	213	18,522	320	27,826	9,304	2.87	26,703
GEY-2	21	1,826	86	7,478	5,652		16,222
GEY-3	13	1,130	57	4,957	3,826		10,981
GEY-4	16	1,391	68	5,913	4,522		12,977
GUE-1	16	835	78	4,070	3,235	2.31	7,472
GUE-2	5	261	208	10,852	10,591		24,466
GUE-3	21	1,096	107	5,583	4,487		10,365
GUE-4	8	417	273	14,244	13,826		31,938
PEN-1	0	0.0	3	216	216	2.74	592
PEN-2	3	216	55	3,960	3,744		10,259
PEN-3	0	0	10	720	720		1,973
PEN-4	5	360	91	6,552	6,192		16,966
PEN-5	3	216	21	1,512	1,296		3,551
PEN-6	5	360	104	7,488	7,128		19,531
PEN-7	47	3,384	278	20,016	16,632		45,572
PEN-8	0	0.0	42	3,024	3,024		8,286
PEN-9	0	0.0	21	1,512	1,512		4,143
<b>TOTAL</b>	<b>930</b>	<b>81,543</b>	<b>8,655</b>	<b>710,752</b>	<b>629,208</b>		<b>1,483,451</b>

Table 5-4 below summarizes the increase in sewage generation by USA.



**Table 5-4. Increase in Sewage Generation by USA**

Urban Service Area	Average Dry-Weather Sewage Generation Increase (gpd)	Sewer Service Provider
Agua Caliente	39,846	Sonoma Valley County Sanitation District
Glen Ellen	4,000	
Sonoma	15,154	
Santa Rosa	236,226	South Park County Sanitation District/City of Santa Rosa
Forestville	112,567	Forestville Water District
Larkfield	59,136	Larkfield-Wikiup Sanitation Zone
Graton	33,603	Graton Community Services District
Geyserville	23,304	Geyserville Sanitation Zone
Guerneville	32,139	Russian River County Sanitation District
Penngrove	40,464	Penngrove Sanitation Zone
Petaluma	32,769	City of Petaluma
<b>TOTAL</b>	<b>629,208</b>	

## 6.0 Water System Analysis

The discussion below summarizes the overall existing conditions within each USA. The individual notes for each parcel with respect to water service is provided in **Table 6-1**.

### Agua Caliente and Glen Ellen

Agua Caliente and Glen Ellen are served by Valley of the Moon Water District (VOMWD). VOMWD receives water from 10 Sonoma Water turnouts and 6 local groundwater wells, five of which are currently active. They operate 10 pumping stations and 13 active storage tanks with total of 5.3 MG storage. They also own two hydro-pneumatic tanks. VOMWD is divided into 12 different pressure zones with the proposed project sites being located in Pressure Zones 1 and 1F. Pressure Zone 1 is the largest zone, while pressure Zone 1F is a very small zone.

Per VOMWD's April 2019 Water Master Plan, six (6) Sonoma Water Turnouts feed directly into Pressure Zone 1 and five (5) groundwater wells are located in Pressure Zone 1. Pressure Zone 1 has access to approximately 5.0 MG of storage in eight (8) tanks.

VOMWD estimates that future demand will plateau and remain relatively stable despite additional population and economic growth due to conservation measures. The projected annual water use from 2020 through 2040 is approximately 3,120 AFY. VOMWD's water supply contract with Sonoma Water entitles the District to 3,200 AFY. In recent years, VOMWD's wells have produced between 450-650 AFY.

VOMWD's 2019 Water Master Plan identified areas of Pressure Zone 1 where fire flow requirements aren't met. Furthermore, portions of the pressure zone are unable to meet minimum pressure requirements under peak hour. However, Pressure Zone 1 has adequate supply and storage to accommodate development.

The system as a whole has a storage deficit of about 260,000 gallons with approximately 200,000 gallons being in Glen Ellen. Future storage deficits in Zone 1F are predicted to be 0.344 MG. The District has initiated the design of a 0.15 MG, but an additional 0.2 MG tank is required to mitigate the entire deficiency in Glen Ellen.

VOMWD appears to have adequate supply to meet the demands of the proposed re-zoning sites. Although VOMWD has identified several fire flow and peak hour pressure deficiencies, the District has outlined 26 capital improvement projects to mitigate these issues.

#### City of Santa Rosa

The City of Santa Rosa owns and operates a distribution system within City limits and purchases water from Sonoma Water. Of the sites under consideration in Santa Rosa, sites SAN-6, SAN-7, and SAN-10 are located outside of the City's boundary, but within the City's sphere of influence, UGB, and USA. The parcels must apply for a Utility Certificate with the City's Planning Division to receive approval to connect to the water system. Sonoma LAFCO will assess and determine if annexation will be a requirement in order to obtain approval for service. SAN-10 is currently located in an area that is only approved for fire protection service. This parcel may not need to be annexed. In addition, City policy states that site SAN-10 can only receive fire protection from the City, and no domestic water. SAN-10 will require a City Council action to waive the policy.

Per the City of Santa Rosa Water Master Plan Update (August 2014), the City owns and operates 24 storage tanks (total of 23.1 MG), 20 water pump stations, and 6 municipal groundwater wells. The service area is divided into 32 pressure zones with the proposed sites located in the Aqueduct Pressure Zone.

The City receives approximately 95% of their water supply from Sonoma Water. Per the Restructured Agreement with Sonoma Water, the City is entitled to 29,100 AFY. The City's groundwater wells can supply an additional 2,300 AFY. The 2015 Urban Water Management Plan projects the City's normal water demands to be 28,140 AFY in year 2040, with a total supply of 31,400 AFY available (not including recycled water or other future water supply projects).

The City appears to have adequate supply to meet the demands of the proposed re-zoning sites. Although the City has identified a storage deficiency at ultimate buildout, the City has a planned capital improvement project to mitigate the deficiency, as well as outlined a robust capital improvement program to mitigate other identified deficiencies throughout the system.

#### City of Sonoma

All four of the parcels are located outside of the City's boundary and therefore would need to be annexed to be eligible to receive water service. None of the parcels have water service directly adjacent; however, the water line at the corner of Leveroni and Broadway has a cross and blind flange towards the south which makes extending water service a possibility. Broadway (Highway 12) is within Caltrans right of way, therefore any pipeline improvements will require coordination and permitting with Caltrans. Furthermore, there is a large storm drain in Broadway that would need to be worked around when designing and constructing a new water line. To develop these parcels, a water demand analysis will need to be performed.

#### Forestville

Forestville is served by the Forestville Water District (FWD). FWD does not have a current Water Master Plan. However, per discussions with the General Manager of FWD, there are no existing capacity deficiencies in the system that would prevent an increase in residential development.

It was noted that two of the sites (FOR-4 and FOR-6) may experience constructability issues. While neither site is in the floodplain, they get localized, seasonal flooding. Site (FOR-1) is the site of the old electro-vector building. Additionally, one of the parcels directly connected to FOR-1 had a church on it that burnt down, and water service is disconnected. The District noted there is adequate supply and storage available to accommodate the additional growth being proposed.

### Larkfield and Geyserville

Larkfield and Geyserville are both served by California American Water (CalAm). CalAm Larkfield receives water from a combination of four (4) groundwater wells and purchased water from SCWA. The agreement that CalAm has with SCWA allowing them to purchase up to 700 acre-feet of potable water per fiscal year expires in 2040. CalAm also has an agreement to purchase additional supply from SCWA to meet peak demands, which expires in 2024.

CalAm completed a Water Supply Assessment (WSA) for the Larkfield area in May of 2022. The WSA results indicated that there would not be enough water supply if the SCWA source was no longer available. The SCWA source will be available until at least 2040 when a new Agreement/negotiations will be required to extend the purchase limits. CalAm staff determined there are no issues with pressure, headloss, or velocity in the pipes adjacent to the proposed project sites. However, all locations have concerns that there is not enough capacity for fire flow in the event that multi-family residences are developed.

Larkfield has four projects planned to address the aforementioned concerns:

1. Construct a 0.5 MG tank to satisfy storage recommendations (may also improve fire flow).
2. Replacement of a number of pipelines within the next 20 years (as identified by a pipe condition assessment).
3. Replace one of the wells within the next 10 years to address aging infrastructure and lost well capacity.
4. Complete an Alternative Source of Supply Study to address projected system-wide shortage (as described in the water supply assessment).

Geyserville receives all of its water supply from groundwater wells. In Geyserville, all proposed sites have capacity concerns within the adjacent water system. GEY-1 is adjacent to a small diameter pipe that cannot support current fire flow requirements. This pipe will require upsizing as dictated per CalAm standards. For the other three sites in this area, further system analysis is required to determine if pipeline upsizing is required in order to meet fire flows. The following projects are planned for completion in Geyserville to address the mentioned deficiencies:

1. Construct a 0.25 MG tank to address current peak hour demand deficiency.
2. Replacement of a number of pipelines within the next 20 years (as identified by a pipe condition assessment).
3. Replace two wells within the next 10 years to address aging infrastructure and lost well capacity.

### Graton

Graton has a small area served by a municipal water system, the Graton Mutual Water District, but the majority of Graton uses private on-site wells for water supply. The five sites in question are located far enough away from the water district boundary that if they are developed it would make more sense to do so by constructing on-site private wells. Annexation would not be required.

### Guerneville

Guerneville is supplied water from both Sweetwater Springs Water District and California Water Service –Armstrong Valley system. GUE-1 is the site for Sweetwater Springs Water District’s main storage and treatment facilities. While it is theoretically possible to move these facilities, the District has said that they would not be willing to relocate this critical infrastructure. Additionally, the environmental impacts of moving or rebuilding the existing water treatment and storage facilities would be significant. The other three sites are within the California Water Service boundary.

The pipe network within the vicinity of the proposed parcels is mostly 2- and 4-inches in diameter and likely cannot provide minimum fire flow requirements for multi-family residential land use. Piping would have to be extended and upsized to reach the GUE-2 site. GUE-3 and GUE-4 have water service directly adjacent to the parcel that is 2-inches and 4-inches in diameter, respectively. All these pipes would need to be upsized to support fire flow requirements.

### Penngrove

Penngrove/Kenwood Water Company is responsible for providing water service to Penngrove residents. All the potential sites are served with water purchased from the Sonoma Water Petaluma Aqueduct that passes through Penngrove. According to the water company manager, the entire Penngrove Town District (PTD) system has sufficient pressure to meet the minimum requirement of 40 psi. The water is purchased fully treated so the PTD does not have any treatment or storage facilities. The main concern is that water purchased from the County is limited based on the established permits. These permits will need to be reviewed to ensure there is sufficient water rights to meet additional demand. Furthermore, if Sonoma Water experiences water shortages, the issue will trickle down to Penngrove.

### Petaluma

The City of Petaluma owns and operates a water distribution system with water purchased from Sonoma Water. None of the proposed parcels are currently within the City boundary and would therefore need to be annexed to receive water service. All other parcels that are located in between the current City boundary and the proposed parcels would need to agree to the annexation as well to have a continuous service boundary. Currently, the City’s Outside Service Area Agreements (OSAA) policy does not support the extension of water service to these parcels. To be eligible for water service, council action would be needed to overturn the policy. If service to these parcels is approved, the 6-inch pipe in Bodega Avenue needs to be upsized to an 8-inch to address capacity issues mainly related to fire flow requirements.

## **6.1 Water System Results**

The following **Table 6-1** summarizes the category designation assigned to each site solely based on the water system research and evaluation. For those sites in Category 2 or 3, the table identifies the steps required to develop the site. The agencies that were not responsive have greyed out boxes. It should be noted that these categories are not inclusive of the sewer analysis.

Furthermore, administrative challenges (such as needing to annex a parcel and receive a utility certificate before water service can be connected) are not factored into the category justification. The sites possessing administrative issues *in addition* to those listed in Table 6-1 are as listed below:

1. SAN-1 to5: Apply for utility certificate
2. SAN-6 and 7: Annex parcels then apply for anew utility certificate
3. SAN-10: Council would need to amend current LAFCO OSAA policy to annex the parcels into the city
4. SON-1 to4: Annex parcels
5. PET-1 to 4: Council would need to amend current LAFCO OSAA policy to annex the parcels into the city

**Table 6-1. Water Category Results**

Site ID	Category	Reason	Mitigations <sup>2</sup>
AGU-1	3	No water service adjacent to parcel and fire flow requirements are not met under peak hour.	Install service lateral going south into AGU-1 and extending to AGU-2. Address FF deficiencies, potentially with a larger pipe.
AGU-2	3	No water service adjacent to parcel.	
AGU-3	1	Site is a straight shot from a turnout so the pressure should be good. Waterlines on two sides.	N/A
GLE-1	3	There are large supply and storage deficits in the pressure zone where these parcels reside.	Upsize 6" ACP in Carquinez Avenue and Gibson Street to 8", build extra storage tanks, a new BPS, and upgrade old BPS.
GLE-2	3		
GRA-1	N/A	Water service is not a requirement for development in Graton. Multifamily development is allowed with a well.	N/A
GRA-2	N/A		
GRA-3	N/A		
GRA-4	N/A		
GRA-5	N/A		
PET-1	2	The 6" pipe in Bodega Avenue has capacity issues	Perform hydraulic analysis per City of Petaluma standards to determine the diameter the pipe needs to be upsized to.
PET-2	2		
PET-3	2		
PET-4	2		
SAN-1	3	No water service adjacent to parcel.	Extend water line.
SAN-2	1	Water service adjacent to parcel	N/A
SAN-3	3	No water service adjacent to parcel.	Extend water line.
SAN-4	1	Parcel is already connected to water service.	N/A
SAN-5	3	No water service adjacent to parcel.	Extend water line.
SAN-6	1	Water service adjacent to parcels.	N/A
SAN-7	1		
SAN-8	3	Water service a few parcels North on Robles Avenue	Extend water service down Morland Avenue from corner of Morland and Robles (extend 3.5 parcels south)
SAN-9	2	Water service adjacent to parcel but not halfway across frontage	Extend water service to halfway across the frontage of the property
SAN-10	1	Water service adjacent to parcel	N/A

<sup>2</sup> To get site to Category 1

Site ID	Category	Reason	Mitigations <sup>1</sup>
FOR-1	2	No water service adjacent to parcel and water is blocked from one side due to a church burning down on an adjacent parcel.	Extension of waterline on side not blocked by fire.
FOR-2	1	Water service on all four sides of parcel.	N/A
FOR-3	1	Water available and no known supply or capacity issues. County owns entire corner.	N/A
FOR-4	2	Lot has water service but is inundated with water all year.	Install drainage measures or grade parcel to be above the flood line.
FOR-5	1	Water available and no known supply or capacity issues.	N/A
FOR-6	3	No water service available and lot is inundated with water all year.	Install drainage measures or grade parcel to be above the flood line. Extend water service to the parcel.
SON-1	1	Water service adjacent to parcels	Water service laterals will need to be constructed.
SON-2	1		
SON-3	1		
SON-4	1		
LAR-1	2	There are concerns that there is not sufficient fire flow capacity for commercial or multi-family development.	Construction of a new 0.5 MG storage tank and replacement of an aging well. Possible upsizing of pipes pending the results of a hydraulic analysis performed according to CalAm standards
LAR-2	2		
LAR-3	2		
LAR-4	2		
LAR-5	2		
LAR-6	2		
LAR-7	2		
LAR-8	2		
GEY-1	2	Small diameter pipe that cannot support fire flow. Peak hour supply deficiency.	Upsize the pipe (diameter to be determined by hydraulic analysis as instructed by CalAm)
GEY-2	2	There are concerns that the adjacent pipes do not have sufficient fire flow for multi-family development. Peak hour supply deficiency.	Construct 0.25 MG tank and perform hydraulic analysis per CalAm's direction to verify required pipe diameters for adjacent piping
GEY-3	2		
GEY-4	2		
GUE-1	3	Site is the location of the Sweetwater Springs Water District main storage and treatment facilities, so water pipes exist. However, discussion with District staff revealed they will not give up the site and the environmental impacts of doing so would be significant.	N/A
GUE-2	2	Water service stops at tip of parcel and is only 2-inches in diameter.	Upsize pipe and extend into the parcel.
GUE-3	2	Water service touch parcels but is only 2-inches in diameter.	
GUE-4	2	Water service is only 4-inches in diameter.	Upsize pipe.

Site ID	Category	Reason	Mitigations <sup>1</sup>
PEN-1	1	Pipes adjacent to parcel and no capacity concerns in pipes	N/A
PEN-2	1	Pipes adjacent to parcel and no capacity concerns in pipes	N/A
PEN-3	1	Pipes adjacent to parcel and no capacity concerns in pipes	N/A
PEN-4	1	Pipes adjacent to parcel and no capacity concerns in pipes	N/A
PEN-5	1	Pipes adjacent to parcel and no capacity concerns in pipes	N/A
PEN-6	1	Pipes adjacent to parcel and no capacity concerns in pipes	N/A
PEN-7	1	Pipes adjacent to parcel and no capacity concerns in pipes	N/A
PEN-8	1	Pipes adjacent to parcel and no capacity concerns in pipes	N/A
PEN-9	2	Pipes in adjacent street but would have to cross through a parcel to connect	Extend water service

## 7.0 Sewer System Analysis

Like the water systems, meetings were held with staff from the sanitation agencies to further discuss and investigate the constraints within each system. Most of the sewer agencies fall under the jurisdiction of Sonoma County Water Agency, who own and operate eight sanitation districts, six of which contains project sites. The four remaining agencies that provide sewer service to a parcel are special districts that are independent of the County.

### Agua Caliente and Glen Ellen

Agua Caliente and Glen Ellen are provided sewer service by Sonoma Valley County Sanitation District (SVCS D). Per the most recent Sewer System Management Plan (SSMP), in January 2021 the trunk of the system has segments inadequate to convey existing peak wet weather flows. Two short segments of 6-inch pipe were also predicted to be surcharged under peak dry weather flow in future conditions. SVCS D has a hydraulic model that is currently being updated. All additional development will require that hydraulic analysis be performed to verify adequate capacity in the system.

SVCS D has identified two projects to address the issues mentioned above. The first is the replacement of the trunk main that is located at the intersection of West Napa Street and Sonoma Highway to the intersection of Happy Lane and Anthony Court. This project involves the replacement of 7,108 linear feet of 21-inch diameter reinforced concrete main with a 27-inch diameter trunk main and the replacement of 31 manholes and will address structural deficiencies and mitigate capacity restricted sections. The project was split into three phases (A, B, and C). Phases A and B have been completed and phase C is nearing completion of the design phase and should be going out to bid in 2022.

The other project is replacing trunk main from the intersection of Happy Lane and Anthony Court to approximately the intersection of Las Flores Drive and Estrella Drive. It will consist of replacing 8,245 linear feet of 21-inch and 18-inch diameter reinforced concrete trunk main with appropriately larger mains and replace 35 manholes. This project will also address structural deficiency and capacity restricted sections. This project is currently in the design phase but the area the project is located has made the design challenging. SVCS D has a request for extension in with the San Francisco RWQCB and are waiting for response.

With these proposed projects implemented, the two currently inadequate pipe segments that are being improved should have adequate capacity to support the proposed re-zoning sites in Agua Caliente. However, there are concerns about the piping adjacent to AGU-2 not having enough capacity to support the site. This will need to be hydraulically investigated to determine whether upsizing will be required.

Both sites in Glen Ellen have had historical issues with sanitary sewer overflows downstream, which is an indication of capacity issues. These sites will need pipeline capacity evaluations to determine if the system will be able to accommodate the future growth.

### City of Santa Rosa

The City of Santa Rosa receives sewer service through both the City of Santa Rosa and the South Park County Sanitation District (SPCSD). SAN-2, SAN-4, SAN-8, and SAN-9 are in the SPCSD service area, and the rest of the parcels are serviced by the City of Santa Rosa. The City of Santa Rosa owns and operates the Laguna Treatment Plant which has a 19.0 MG capacity for tertiary treatment and has peak treatment capacity at 30-40 MGD. In addition to treating wastewater for the City of Santa Rosa and the SPCSD, the plant also takes wastewater flows from Rohnert Park, Cotati, and Sebastopol.

Per the 2016 SSMP, the system has only experienced four sanitary sewer overflows (SSOs) since 2008 with none of them being attributed to blockage. Based upon these results, SPCSD has determined that there are no capacity deficiencies. Furthermore, SPCSD has plans to repair, rehabilitate, and construct portions of collection system by 2024. With these proposed projects implemented, the system should have adequate capacity to support the proposed re-zoning sites.

Of the sites under consideration in Santa Rosa, sites SAN-6, SAN-7, and SAN-10 will require utility certificates and approval of the Sonoma Local Agency Formation Commission (LAFCO). These parcels are located outside of the City's boundary but within the City's sphere of influence, UGB, and USA. LAFCO may determine that these parcels need to be annexed but it is likely that only SAN-7 will require the annexation since it borders the City limits. Parcels SAN-1, SAN-3 and SAN-5 are subject to the conditions of the Brooks Assessment District (AD), which limit the property to the existing connected load of one single-family dwelling unit.

### City of Sonoma

The City of Sonoma receives sewer service from Sonoma Valley County Sanitation District. There are four parcels being investigated in Sonoma. All four parcels are located directly adjacent to Broadway (Highway 12) which has large diameter trunk mains along the road. Broadway tends to surcharge during the winter months but there are no SSOs experienced during the surcharge. All the parcels have large diameter pipes adjacent so it is expected that there will be excess capacity within the system to accommodate the additional generation. This will need to be verified with a hydraulic model analysis. Furthermore, wastewater treatment discharge permits will need to be reviewed to verify that the treatment plant has adequate capacity.

Please note that these parcels do not require annexation into the City to receive sewer service. This is because they are in the sphere of influence of SVCSD which operates independently of the City.

### Forestville

Forestville receives sewer service from the Forestville Water District (FWD). As discussed in the water analysis section, two of the six parcels collect standing water seasonally. This can cause inflow/infiltration and constructability issues. Four parcels do not have sewer service directly



adjacent to the parcel. FOR-5 has sewer service on the corner of the parcel and on Packing House Road which can be extended for the use of the parcel. There are no known capacity issues.

### Larkfield

Larkfield receives sewer service from the Airport-Larkfield-Wikiup Sanitation Zone (ALWSZ). Per the SCWA website, the ALWSZ wastewater treatment plant has a permitted treatment capacity of 900,000 gallons per day (gpd). The hydraulic model analysis evaluation, conducted as a part of the 2021 SSMP, indicated the trunk sewer system has adequate capacity to convey all existing and future flows. However, the 2020 Sonoma County General Plan Public Facilities and Services Element indicates the Airport/Larkfield/Wikiup Sanitation Zone as having limited capacity for accommodating future growth at the treatment plant. This issue is worsened by flooding concerns at all Larkfield sites which may contribute to inflow and infiltration into the system.

Before any development, sewer capacity will still need to be verified with a hydraulic model analysis. The sanitation zone is currently updating their collection system model and are looking to start a Master Plan for the Treatment Plant this year (2022). Both studies will help to verify the improvements that are needed to handle additional development.

### Geyserville

Geyserville receives sewer service from the Geyserville Sanitation Zone (GSZ). Per the June 2016 SSMP, GSZ's wastewater treatment plant has a treatment capacity of 92,000 gpd but currently treats approximately 45,000 gpd. Since 2008, GSZ has only experienced one SSO that was attributed to blockage. The capacity assessment completed for the 2021 SSMP found no hydraulic capacity deficiencies in the system. While the system is in good condition, the piping adjacent to the parcels in question are two (2) 6-inch diameter sewer pipes and it will need to be hydraulically analyzed to determine if upsizing is required.

### Graton

Graton receives wastewater services from Graton Community Services District. The main concern with the parcels in Graton is the condition of the conveyance piping which has many structural and O&M defects. Furthermore, the main lift station used by the District is in bad condition and has capacity concerns. However, much of the existing trunk already has stubbed out laterals which would be very easy to connect additional services to.

One of the sites, GRA-4, is not within the service area for GCSD. To add it to the sphere of influence, the County would need to make a General Plan consistency determination, a municipal service review would need to be carried out, and an application would need to be submitted to LAFCO.

It should be noted that an individual party is in the process of trying to rezone and develop GRA-5. They have the intent of constructing 16-20 small units.

### Guerneville

Guerneville's sewer system is managed by the Russian River County Sanitation District. Per the 2021 SSMP, the trunk has adequate capacity to convey existing and future peak dry weather flows. However, all four sites, GUE-1, 2, 3, and 4 reside in flood plains. When the river floods, the system experiences high inflow and infiltration, often resulting in SSOs. In 2017 and 2019, there were several large SSOs. The excessive inflow will need to be mitigated or the pipes will need to be upsized to accommodate additional development. Besides the issues with flooding, the Russian

River system is in good condition.

Site GUE-1 houses the main storage and water treatment facilities for Sweetwater Springs Water District. As such, this site would require the treatment plant to be relocated in order to redevelop. Discussions with the District indicated that they will not give up the site. Furthermore, the environmental impacts of relocation would be significant.

### Penngrove

Penngrove receives sewer service from the Penngrove Sanitation Zone (PSZ). Flows generated within the PSZ flow through the City of Petaluma's system and to the City's wastewater treatment plant. For the January 2021 SSMP, Agency staff conducted a capacity assessment of the PSZ system and concluded that the sanitation zone has not experienced any SSOs due to hydraulic deficiencies within the system so no formal capacity mitigation measures are planned. However, the lift station adjacent to the creek has been subject to flooding and the force main will eventually need structural upgrades and possible relocation.

The system experienced three SSOs between December 2014 and March 2016 occurring just upstream of a lift station where the capacity was exceeded. During the SSOs, the lift station had to be turned off due to flooding. If flood waters were to reach the lift station, it would cause major damage that could take the lift station out of service. However, the sanitation zone is implementing a project that will allow for the lift station to continue to operate during a flood.

The District is looking to have a capacity analysis underway later this year that will determine if the pipes need to be upsized. There are also concerns with septic failures in the area so it is possible that a parcel experiencing septic failure will need to be connected to the system. The Penngrove sites may be viable for additional development upon completion of the capital improvement projects and a revised agreement with the City of Petaluma for treatment.

Sites PEN-2 and 4 are currently on septic and will require the extension of a sewer pipeline up Goodwin Avenue for service. Sites PEN-1, 3, 5 and 8 have flooding concerns.

### Petaluma

The City of Petaluma operates a wastewater treatment facility that provides tertiary treatment. The treatment plant also takes wastewater flows from Penngrove Sanitation Zone. All of the parcels would need to be annexed into the City to receive sewer service. The current OSAA policy does not support the extension of sewer service to these parcels and will require City Council action to allow.

PET-1 does not have sewer service adjacent to the parcel, but the other three sites do. The sewer line is 6-inches in diameter and resides in Bodega Avenue. Before development can be considered for these sites, the pipe will need to be upsized to address capacity concerns.

## **7.1 Sewer System Results**

The following **Table 7-1** summarizes the categorical results of each site based on the above analysis. Like the water analysis, a summary of actions required to redevelop the site has been identified.

**Table 7-1. Sewer Category Results**

Site ID	Category	Reason	Mitigations <sup>1</sup>
AGU-1	1	Water service exists and the main trunk line are proposed to be upsized from 21" to 27" in the summer of 2021 to handle current flows so pipe capacity is good. May handle additional flow as well.	N/A
AGU-2	2	Same as AGU-1 but this site is much larger so there are potential pipe capacity issues.	Run a hydraulic model to determine the effect on capacity.
AGU-3	1	Sewer service exists adjacent to parcel and no known capacity issues.	N/A
GLE-1	2	Issues with sanitary sewer overflows (SSOs) further upstream indicating capacity issues.	Perform a hydraulic analysis to determine what size the pipe needs to be to handle flow. Upsize pipe.
GLE-2	2		
GRA-1	1	Sewer on two sides of parcel and infrastructure in good shape according to CCTV data.	N/A
GRA-2	2	Sewer service exists but is close to a lift station that has condition and capacity concerns. The lift station would need to be used to develop this parcel.	Perform upgrades to lift station and run hydraulic model to determine if the pipe needs to be upsized.
GRA-3	1	Infrastructure exists and there is a stubbed out lateral extending into the parcel.	N/A
GRA-4	3	No sewer infrastructure exists adjacent to parcel. Parcel is outside of District boundary.	Submit application to LAFCO to amend the sphere of influence of the District. County needs to amend general plan to incorporate parcel. A municipal service review will be required and then the parcel can be annexed to the District. Then extend sewer service up to parcel.
GRA-5	1	Infrastructure exists and an independent party is in the process of trying to purchase the land to build 20-60 small units.	N/A
PET-1	3	No sewer service adjacent to parcel and parcel is not in the City's boundary. LAFCO's current OSAA policy does not support the extension of sewer services to this parcel.	Council action will be needed to amend the current LAFCO OSAA policy. The parcels would then need to be annexed into the City. Council action will be needed to amend the current LAFCO OSAA policy. The parcels would then need to be annexed into the City. Council action will be needed to amend the current LAFCO OSAA policy. The parcels would then need to be annexed into the City.
PET-2	3	The 6" sewer pipe in Bodega Avenue that fronts these parcels has capacity issues. All of these parcels are not in the City's boundary. LAFCO's current OSAA policy does not support the extension of sewer services to this parcel.	
PET-3	3		
PET-4	3		

Site ID	Category	Reason	Mitigations <sup>1</sup>
SAN-1	2	Currently connected to sewer	Need to get a utility certificate to get additional service. The additional generation needs to be calculated and must not cause sewer generation to exceed that which is allowed in the General Plan and Wastewater Master Plan.
SAN-2	2	Sewer service does not extend halfway across the frontage of the property.	Sewer line would need to be extended so that it is halfway across the frontage of the property. See SAN-1 as well.
SAN-3	2	Sewer service adjacent to parcel but lot is currently vacant and would be limited to one residential connection	Site is very large to only develop one parcel. Further investigation needed to determine how to amend restriction. Utility certificate most likely needed.
SAN-4	1	Sewer service on three sides of the parcel	N/A
SAN-5	2	Sewer service adjacent to parcel but lot is currently vacant and would be limited to one residential connection	Site is very large to only develop one parcel. Further investigation needed to determine how to amend restriction. Utility certificate most likely needed.
SAN-6	2	Already has sewer on one side but is no within City's boundary	Parcels need to be annexed and utility certificates acquired.
SAN-7	2		
SAN-8	2	Sewer already connected to South Park County Sanitation District System	See note for SAN-1
SAN-9	2		
SAN-10	3	No sewer service adjacent to parcel and LAFCO's current OSAA policy does not allow for the extension of sewer services to this parcel.	Council action would be needed to amend the OSAA policy. Parcel would need to be annexed. All steps from SAN-1 are also valid.
FOR-1	3	No sewer service adjacent to parcel.	Extend sewer service.
FOR-2	3	No sewer service adjacent to parcel.	Extend sewer service in Mirabel Road to the corner of Mirabel Road and Nolan Road.
FOR-3	3	No sewer service adjacent to parcel.	Sewer service would be easy to extend up to the parcel but land is flat so grading would likely be needed to get adequate slope.
FOR-4	2	Sewer service exists but the lot is inundated with water all year.	Drainage measures would need to be installed.
FOR-5	1	Sewer service is available.	N/A
FOR-6	3	No sewer service adjacent to parcel. Majority of lot is inundated all year.	Sewer services would need to be extended and drainage measures installed.
SON-1	2	The pipe in Broadway tends to surcharge without SSOs during winter months but parcels are low in the system and pipes are large.	Run hydraulic model with proposed flows to verify how much additional flow can be handled. Determine if upsizing is needed to handle flows.
SON-2	2		
SON-3	1	Sewer on two sides of parcel and excess capacity likely available because one adjacent pipe is 30-inches in diameter.	N/A

Site ID	Category	Reason	Mitigations <sup>1</sup>
SON-4	2	The pipe in Broadway tends to surcharge without SSOs during winter months.	See SON-1/2
LAR-1	2	Parcels are close to Wikiup Creek and so there are flooding issues. Concerns with treatment plant capacity.	Increase the capacity at the WWTP or upgrade lines so there is less inflow and infiltration from Wikiup Creek flooding.
LAR-2	2		
LAR-3	2	Concerns with treatment plant capacity.	
LAR-4	2		
LAR-5	2		
LAR-6	2	Parcels are close to Wikiup Creek and so there are flooding issues. Concerns with treatment plant capacity.	
LAR-7	2	Concerns with treatment plant capacity.	
LAR-8	2	Trunk collection line has excess capacity but there are concerns about the capacity of the treatment plant.	
GEY-1	3	No sewer line adjacent to parcel.	Extend (and possibly upsize) the 8" PVC in Geyserville Avenue. Construct new manhole.
GEY-2	2	All parcels are adjacent to Geyserville Avenue which has two (2) 6-inch diameter pipes in good condition. There are concerns about disposal capacity at the treatment plant.	Evaluate excess disposal capacity determine a way to increase capacity at the treatment plant if necessary.
GEY-3	2		
GEY-4	2		
GUE-1	3	This site has Sweetwater Springs Water District's main treatment and storage facilities. Likely has sewer pipes already. However, the District is not willing to relocate and doing so would require a large environmental impact.	N/A
GUE-2	2	Entire system gets flooded often and experiences SSOs because of it. The property here is low lying which leads to large amounts of inflow.	Upsize pipes and/or take measures to mitigate the inflow being experienced in the area.
GUE-3	2		
GUE-4	2		
PEN-1	2	Site is subject to flooding.	Hydraulic analysis to determine how flooding impacts the capacity. Potentially upsize pipe. The District is hoping to start the capacity analysis later this year.
PEN-2	3	No sewer line adjacent to parcel. Many people in the area are on septic and excess capacity is needed for septic failures. Not in service area.	Extend (and possibly upsize) the sewer main in Goodwin Avenue. Determine if there is excess capacity in the event of the worst septic failure. Permit may be required for service.
PEN-3	2	Site is subject to flooding.	See PEN-1
PEN-4	1	Infrastructure exists and there are no concerns with SSOs in this area.	N/A
PEN-5	1		
PEN-6	1		
PEN-7	2	Sewer service stops just before parcel but there are no concerns with inflow due to flooding.	Extend sewer service to parcel.
PEN-8	2	Site is subject to flooding.	See PEN-1
PEN-9	3	No sewer line adjacent to parcel.	Extend (and possibly upsize) the 6" main that stops at PEN-8.

## 8.0 Results

Of the 59 potential sites, 8 were classified as Category 1, 28 as Category 2, and 23 as Category 3. The full categorical results are listed below in **Table 8-1**. It should be noted that water agencies that did not provide system information or meet with us, the sewer category was applied to the overall category. This may not be accurate and should be reassessed as new information arises.

It is noted that this Study was a paper study only and did not include hydraulic model analyses of either the water or sewer systems. It is recommended that more detailed studies be completed for future development projects on the proposed sites to verify fire flow availability and system capacity (both in the systems and at the treatment plants). The specific studies will be agency specific and completed by the developer.

**Table 8-1. Full Categorical Results for Each Site**

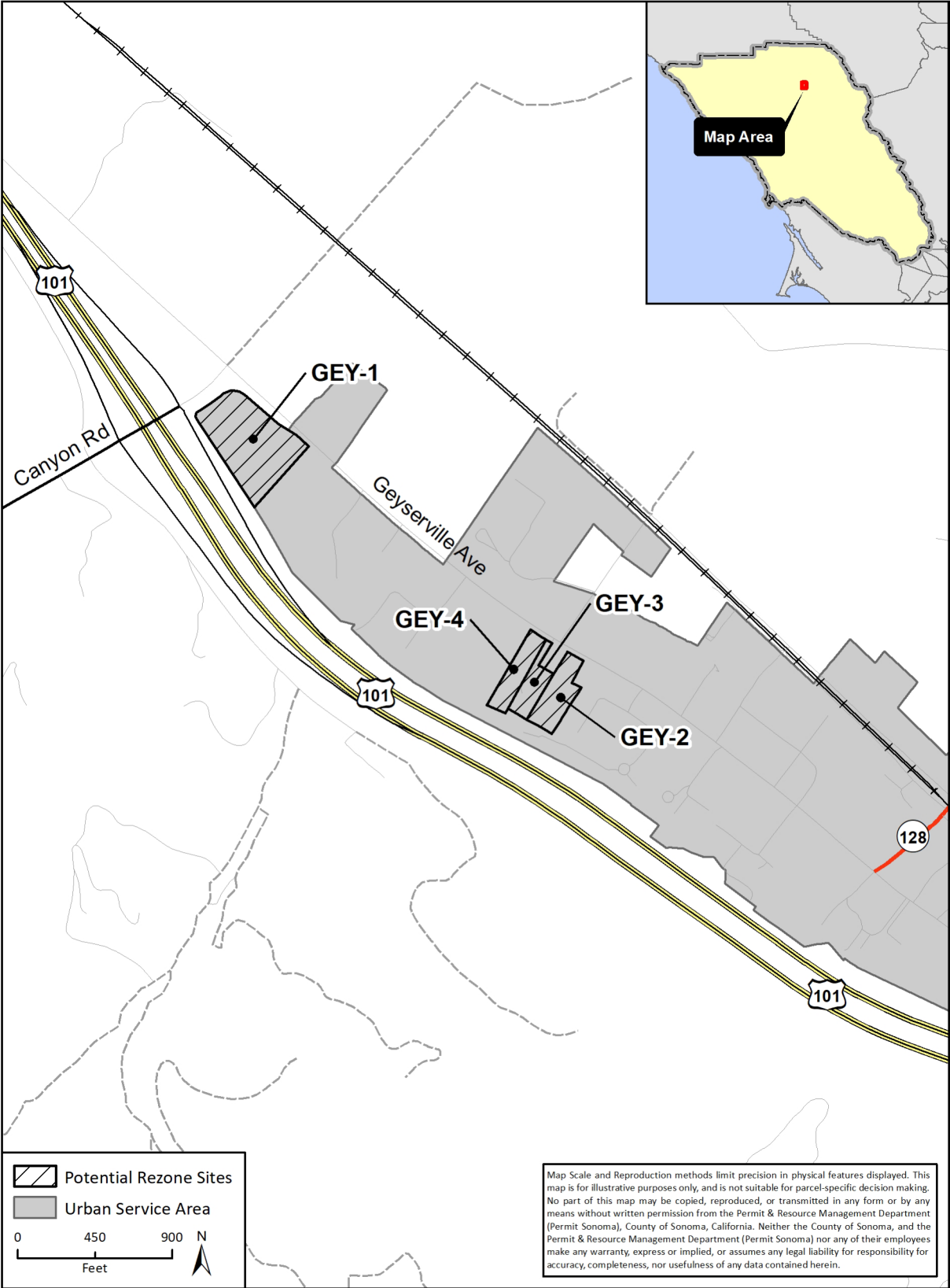
Site ID	Water Category	Sewer Category	Overall Category
AGU-1	3	1	3
AGU-2	3	2	3
AGU-3	1	1	1
GLE-1	3	2	3
GLE-2	3	2	3
GRA-1	N/A	1	1
GRA-2	N/A	2	2
GRA-3	N/A	1	1
GRA-4	N/A	3	3
GRA-5	N/A	1	1
PET-1	2	3	3
PET-2	2	3	3
PET-3	2	3	3
PET-4	2	3	3
SAN-1	3	2	3
SAN-2	1	2	2
SAN-3	3	2	3
SAN-4	1	1	1

Site ID	Water Category	Sewer Category	Overall Category
SAN-5	3	2	3
SAN-6	1	2	2
SAN-7	1	2	2
SAN-8	3	2	3
SAN-9	2	2	2
SAN-10	1	3	3
FOR-1	2	3	3
FOR-2	1	3	3
FOR-3	1	3	3
FOR-4	2	2	2
FOR-5	1	1	1
FOR-6	3	3	3
SON-1	1	2	2
SON-2	1	2	2
SON-3	1	1	1
SON-4	1	2	2
LAR-1	2	2	2
LAR-2	2	2	2
LAR-3	2	2	2
LAR-4	2	2	2
LAR-5	2	2	2
LAR-6	2	2	2
LAR-7	2	2	2
LAR-8	2	2	2
GEY-1	2	3	3
GEY-2	2	2	2

Site ID	Water Category	Sewer Category	Overall Category
GEY-3	2	2	2
GEY-4	2	2	2
GUE-1	3	3	3
GUE-2	2	2	2
GUE-3	2	2	2
GUE-4	2	2	2
PEN-1	1	2	2
PEN-2	1	3	3
PEN-3	1	2	2
PEN-4	1	1	1
PEN-5	1	1	1
PEN-6	1	1	1
PEN-7	1	2	2
PEN-8	1	2	2
PEN-9	2	3	3

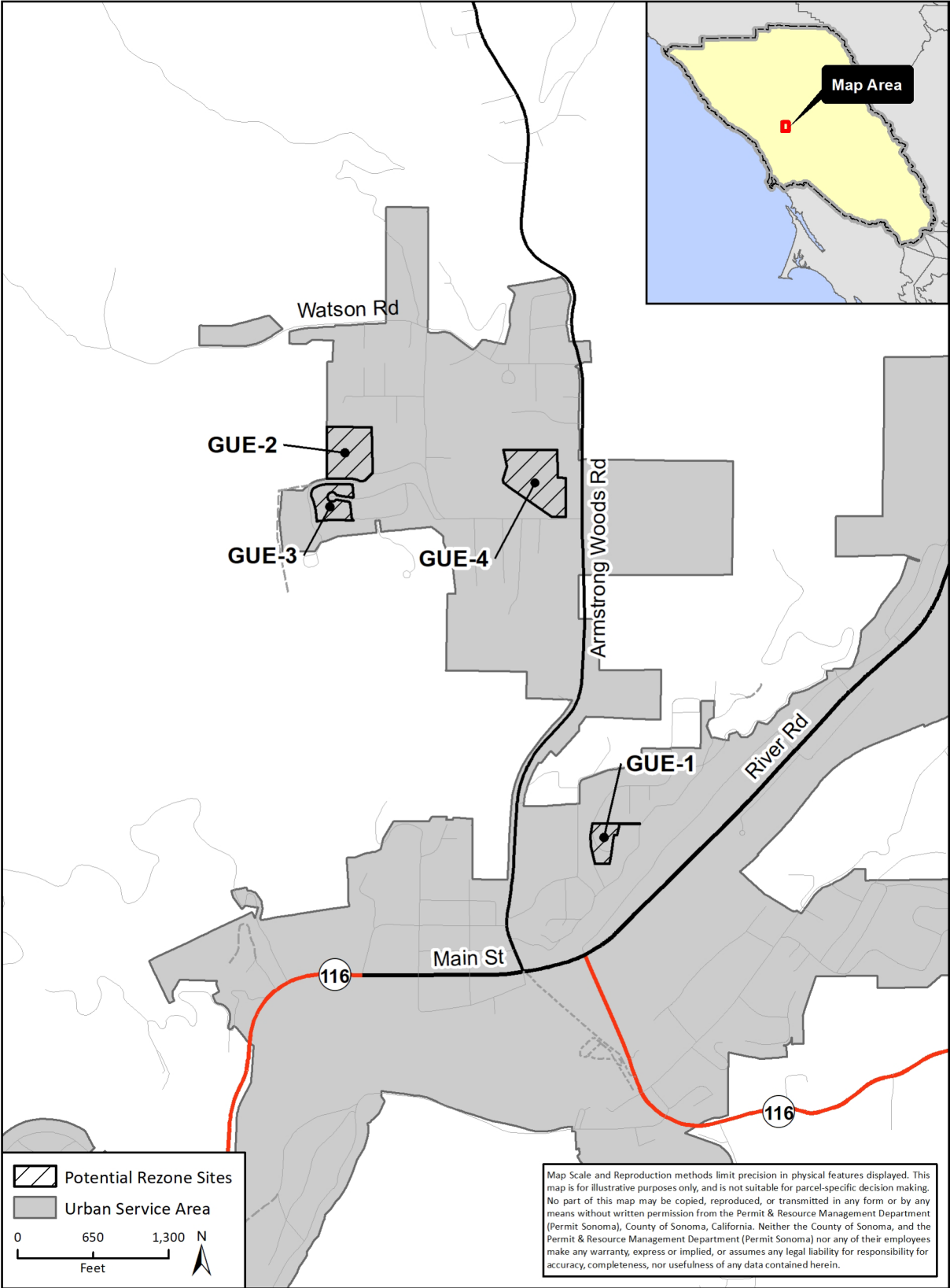


## **Appendix A – Maps of Sites Under Consideration by USA**

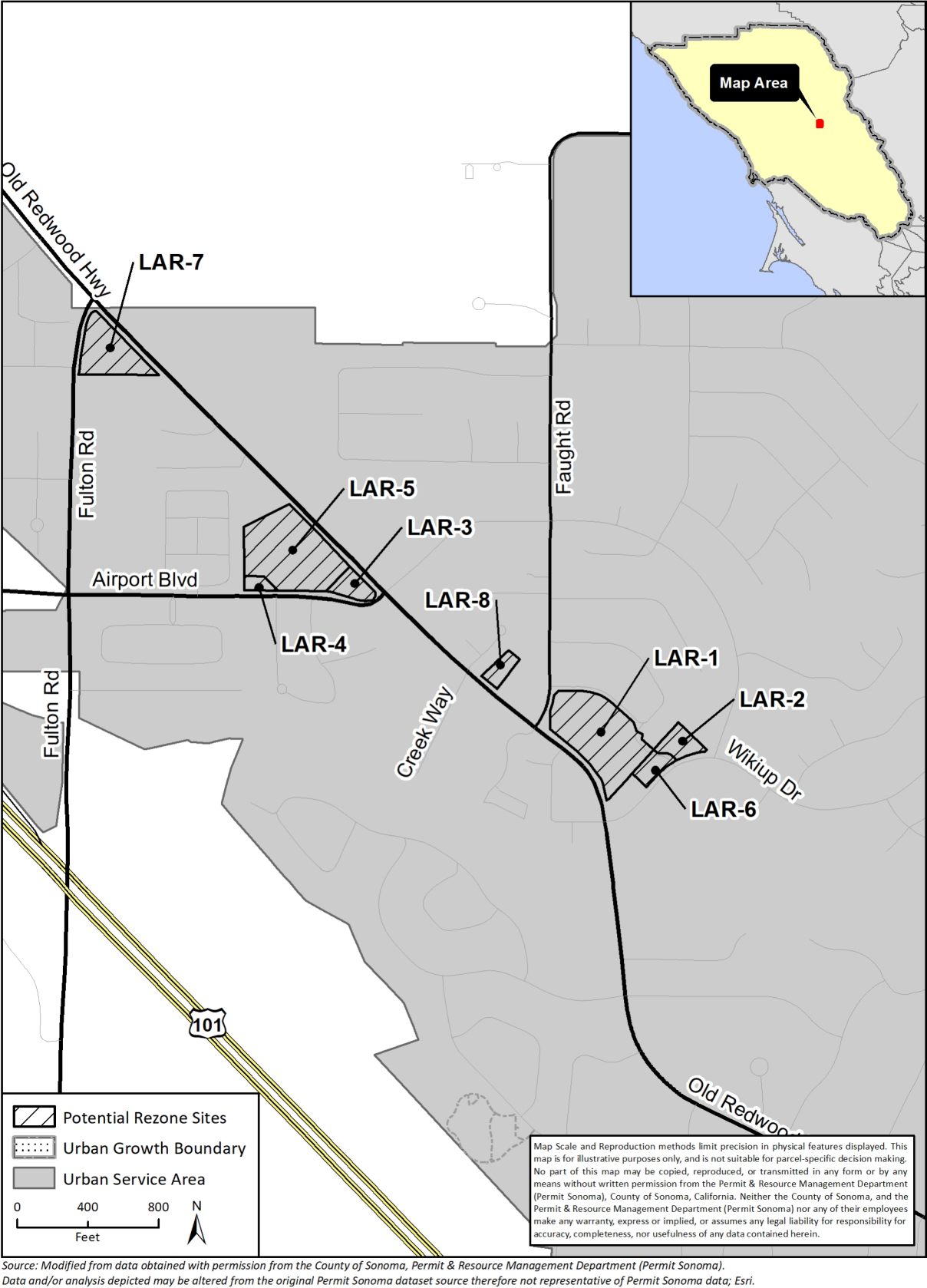


Source: Modified from data obtained with permission from the County of Sonoma, Permit & Resource Management Department (Permit Sonoma).

Data and/or analysis depicted may be altered from the original Permit Sonoma dataset source therefore not representative of Permit Sonoma data; Esri.



Source: Modified from data obtained with permission from the County of Sonoma, Permit & Resource Management Department (Permit Sonoma).  
 Data and/or analysis depicted may be altered from the original Permit Sonoma dataset source therefore not representative of Permit Sonoma data; Esri.



Map Area

LAR-7

LAR-5

LAR-3

LAR-8

LAR-1

LAR-2

LAR-4

LAR-6

Old Redwood Hwy

Fulton Rd

Faught Rd

Airport Blvd




Fulton Rd

Creek Way

Wikiup Dr

101

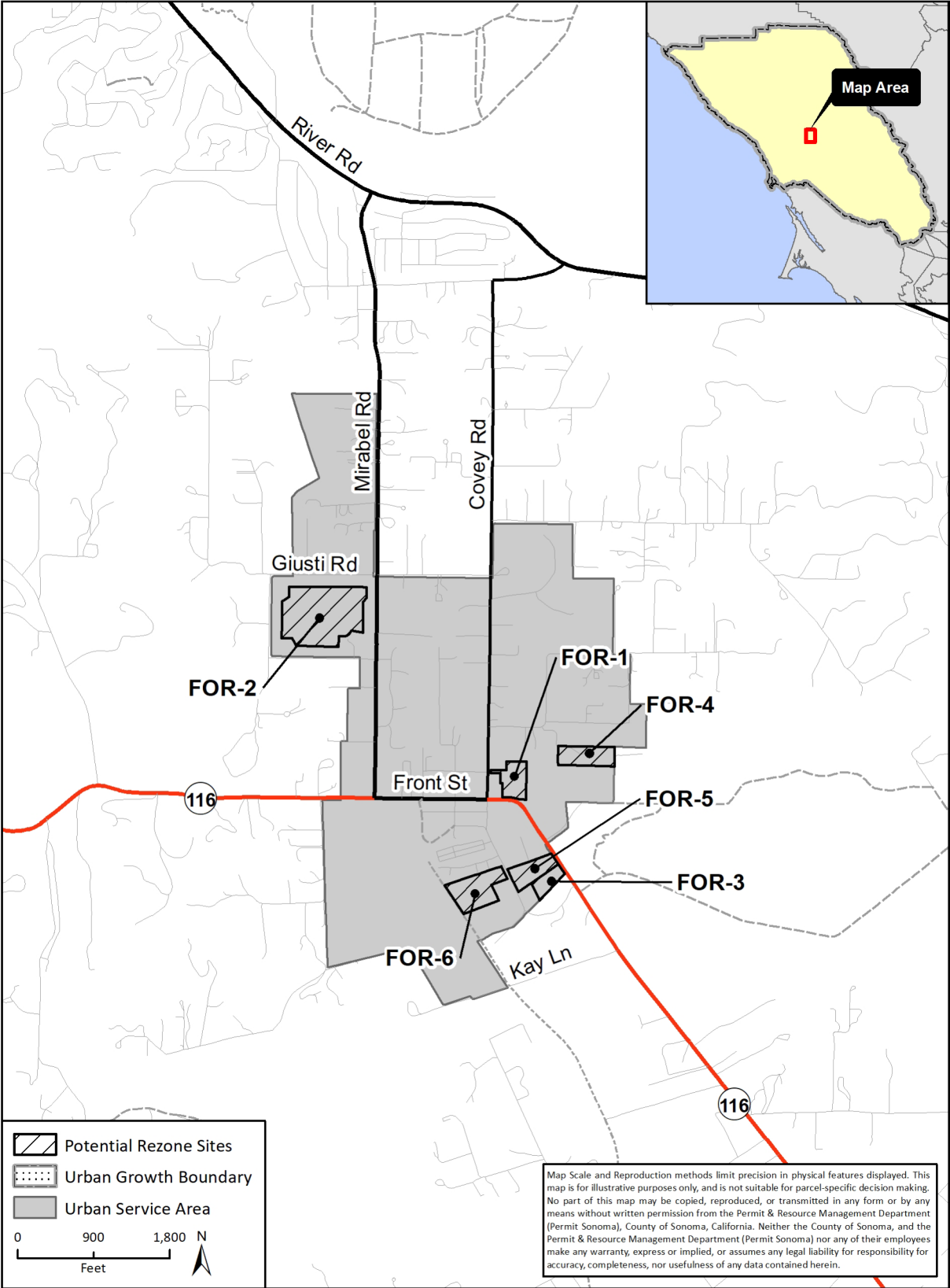
Old Redwood




 Potential Rezone Sites  
 Urban Growth Boundary  
 Urban Service Area

0      400      800      N  
 Feet

Map Scale and Reproduction methods limit precision in physical features displayed. This map is for illustrative purposes only, and is not suitable for parcel-specific decision making. No part of this map may be copied, reproduced, or transmitted in any form or by any means without written permission from the Permit & Resource Management Department (Permit Sonoma), County of Sonoma, California. Neither the County of Sonoma, and the Permit & Resource Management Department (Permit Sonoma) nor any of their employees make any warranty, express or implied, or assumes any legal liability for responsibility for accuracy, completeness, nor usefulness of any data contained herein.

Source: Modified from data obtained with permission from the County of Sonoma, Permit & Resource Management Department (Permit Sonoma).  
 Data and/or analysis depicted may be altered from the original Permit Sonoma dataset source therefore not representative of Permit Sonoma data; Esri.

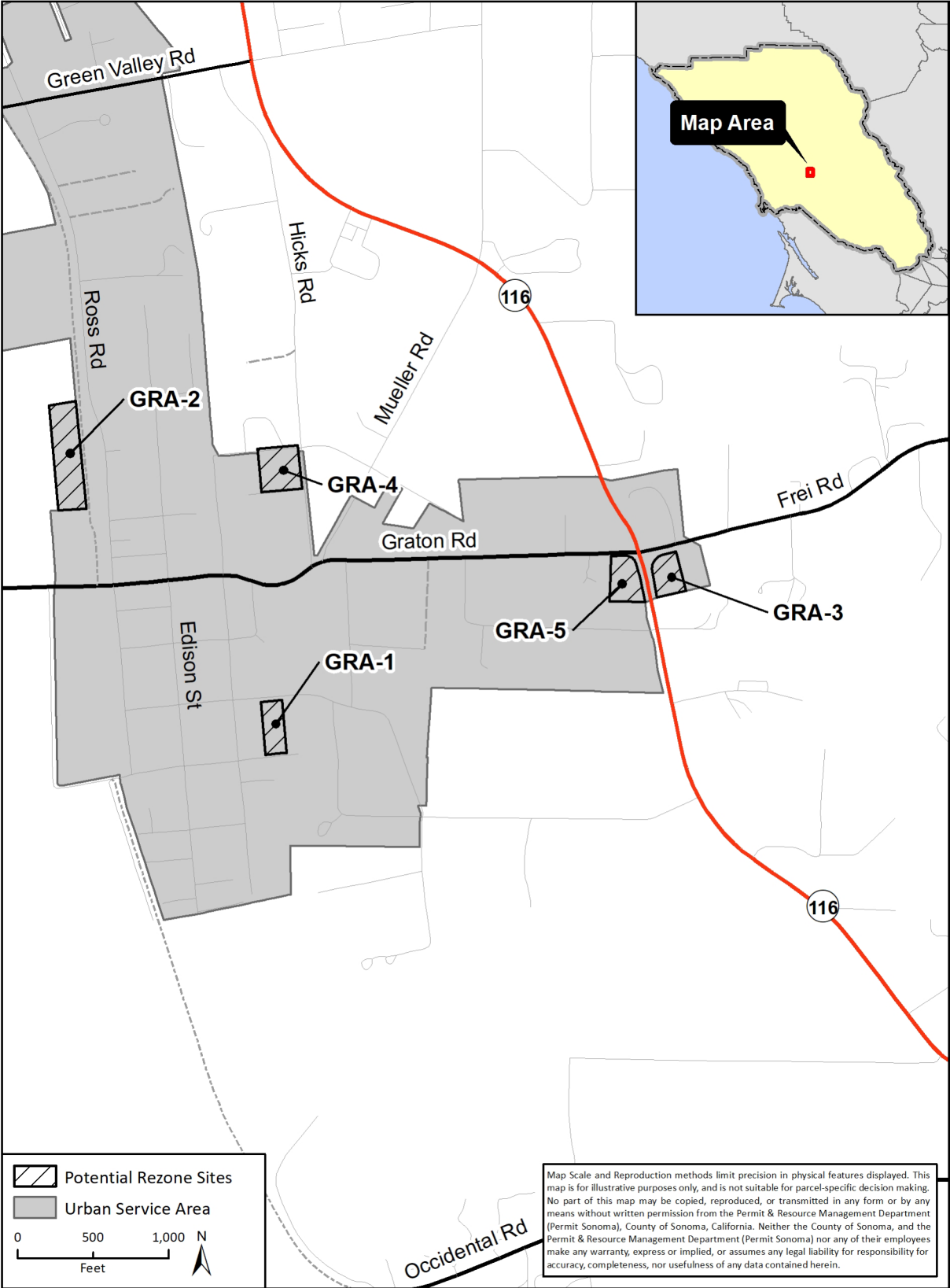


 Potential Rezone Sites  
 Urban Growth Boundary  
 Urban Service Area

0      900      1,800      N  
 Feet

Map Scale and Reproduction methods limit precision in physical features displayed. This map is for illustrative purposes only, and is not suitable for parcel-specific decision making. No part of this map may be copied, reproduced, or transmitted in any form or by any means without written permission from the Permit & Resource Management Department (Permit Sonoma), County of Sonoma, California. Neither the County of Sonoma, and the Permit & Resource Management Department (Permit Sonoma) nor any of their employees make any warranty, express or implied, or assumes any legal liability for responsibility for accuracy, completeness, nor usefulness of any data contained herein.

Source: Modified from data obtained with permission from the County of Sonoma, Permit & Resource Management Department (Permit Sonoma).  
 Data and/or analysis depicted may be altered from the original Permit Sonoma dataset source therefore not representative of Permit Sonoma data; Esri.



Map Area

116

116



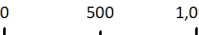
GRA-2

GRA-4

GRA-5

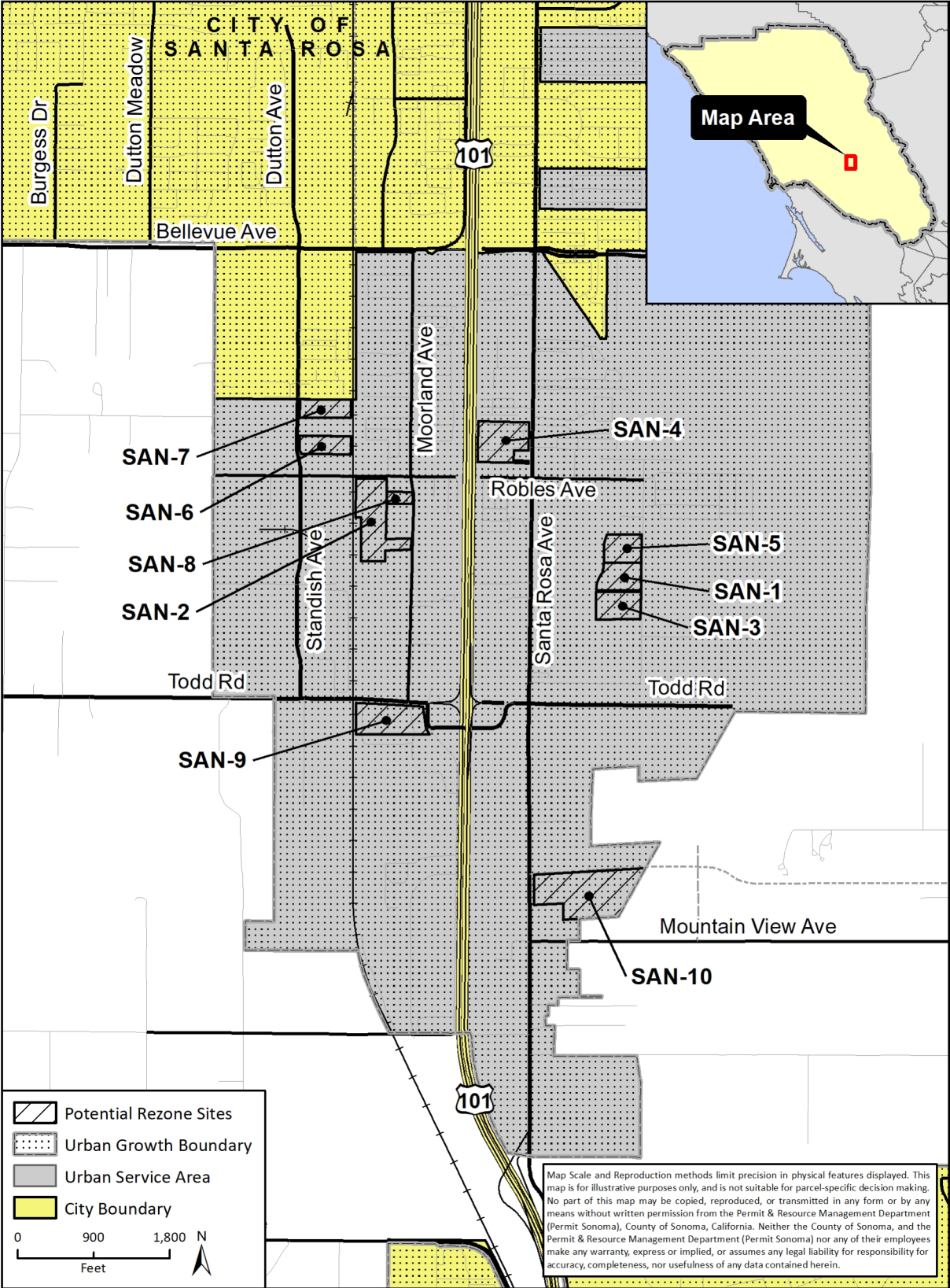
GRA-3

GRA-1

 Potential Rezoning Sites  
 Urban Service Area  
 0      500      1,000      N  
  
 Feet

Map Scale and Reproduction methods limit precision in physical features displayed. This map is for illustrative purposes only, and is not suitable for parcel-specific decision making. No part of this map may be copied, reproduced, or transmitted in any form or by any means without written permission from the Permit & Resource Management Department (Permit Sonoma), County of Sonoma, California. Neither the County of Sonoma, and the Permit & Resource Management Department (Permit Sonoma) nor any of their employees make any warranty, express or implied, or assumes any legal liability for responsibility for accuracy, completeness, nor usefulness of any data contained herein.

Source: Modified from data obtained with permission from the County of Sonoma, Permit & Resource Management Department (Permit Sonoma).  
 Data and/or analysis depicted may be altered from the original Permit Sonoma dataset source therefore not representative of Permit Sonoma data; Esri.



**CITY OF SANTA ROSA**

**Map Area**





**SAN-7**  
**SAN-6**  
**SAN-8**  
**SAN-2**

**SAN-4**

**SAN-5**  
**SAN-1**  
**SAN-3**

**SAN-9**

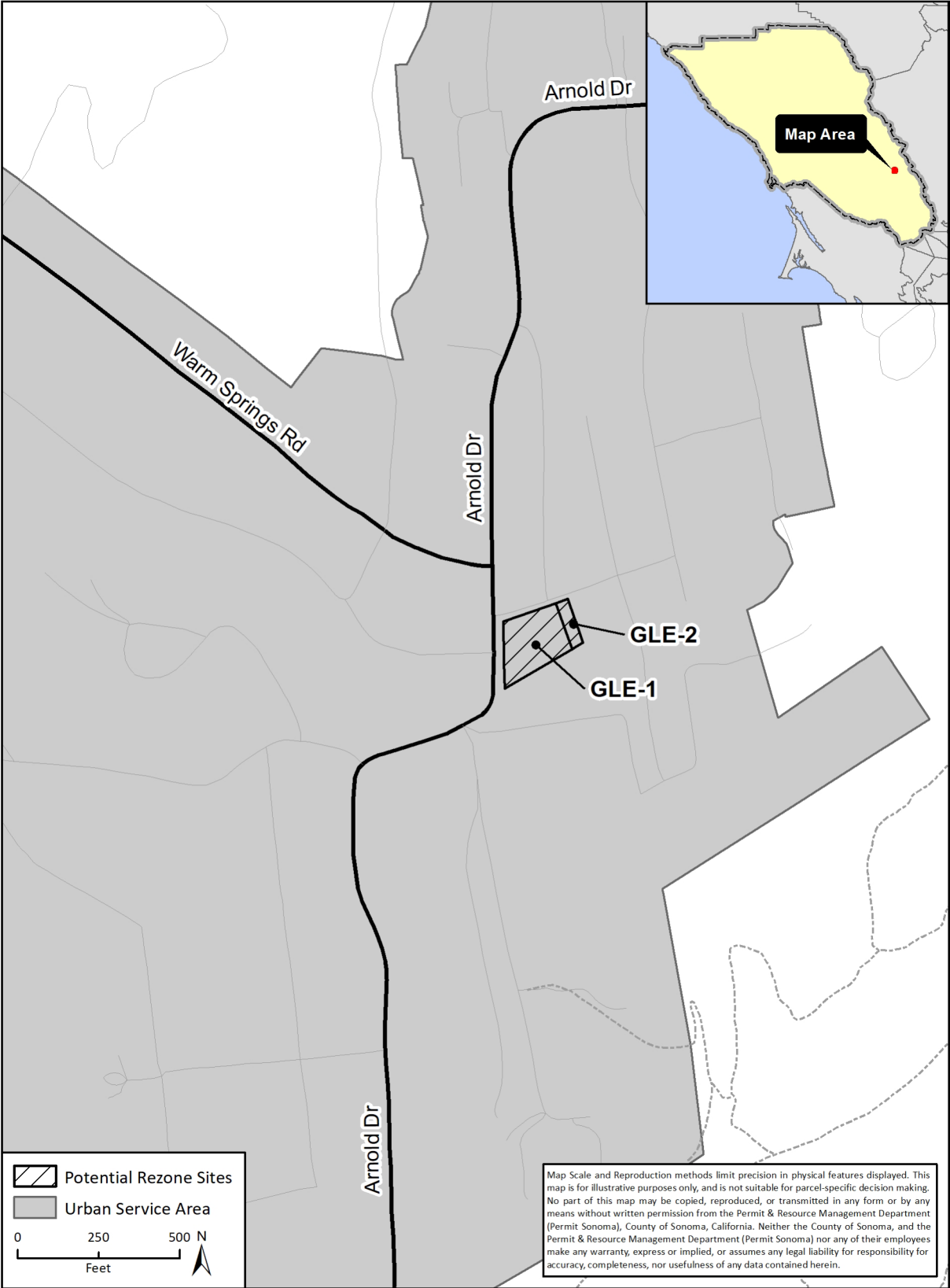
**SAN-10**



 Potential Rezone Sites  
 Urban Growth Boundary  
 Urban Service Area  
 City Boundary

0 900 1,800 N  
Feet

Map Scale and Reproduction methods limit precision in physical features displayed. This map is for illustrative purposes only, and is not suitable for parcel-specific decision making. No part of this map may be copied, reproduced, or transmitted in any form or by any means without written permission from the Permit & Resource Management Department (Permit Sonoma), County of Sonoma, California. Neither the County of Sonoma, and the Permit & Resource Management Department (Permit Sonoma) nor any of their employees make any warranty, express or implied, or assumes any legal liability for responsibility for accuracy, completeness, nor usefulness of any data contained herein.

Source: Modified from data obtained with permission from the County of Sonoma, Permit & Resource Management Department (Permit Sonoma).  
 Data and/or analysis depicted may be altered from the original Permit Sonoma dataset source therefore not representative of Permit Sonoma data; Esri.

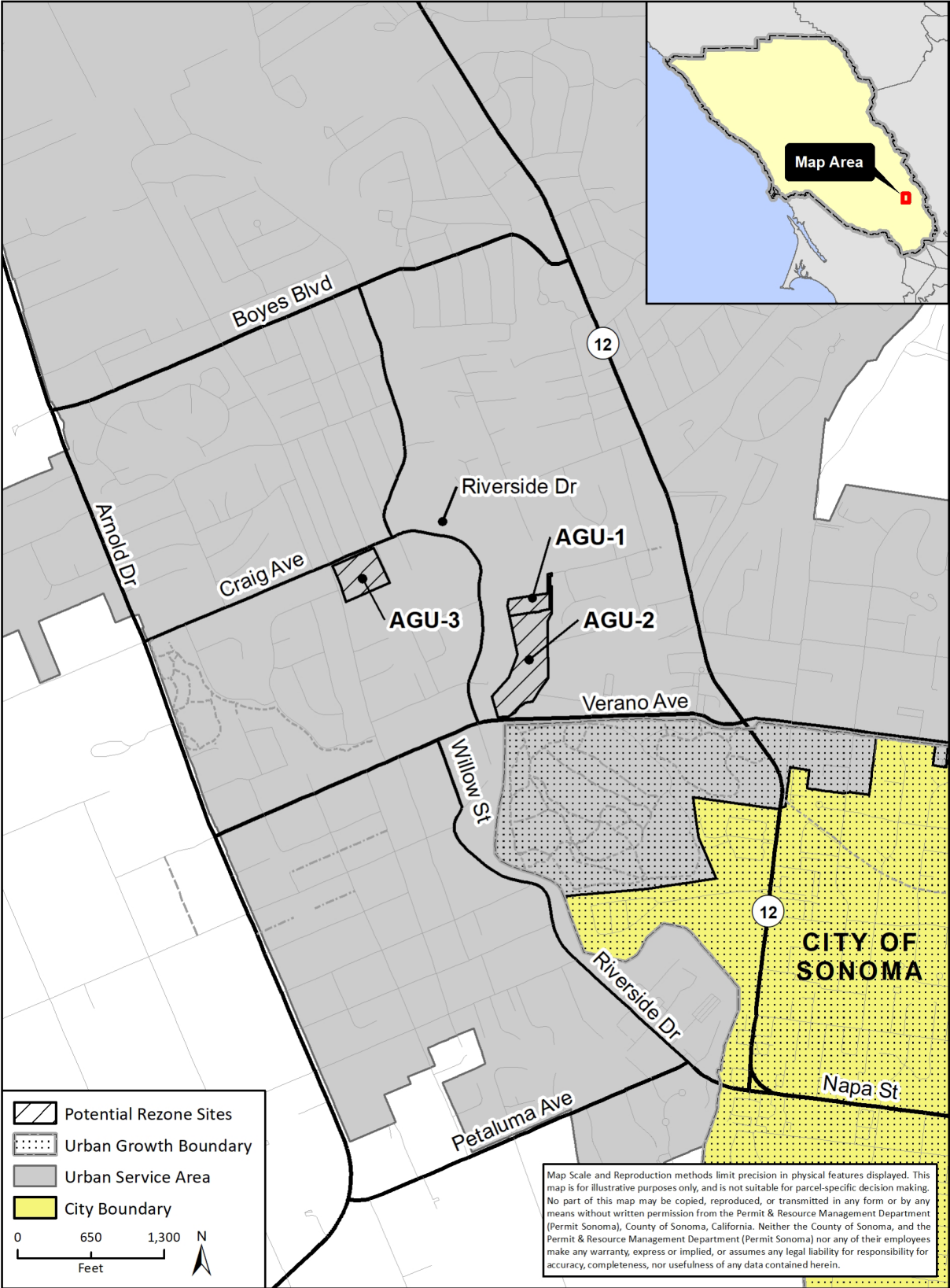


 Potential Rezoning Sites  
 Urban Service Area  
 0 250 500 N  
 Feet

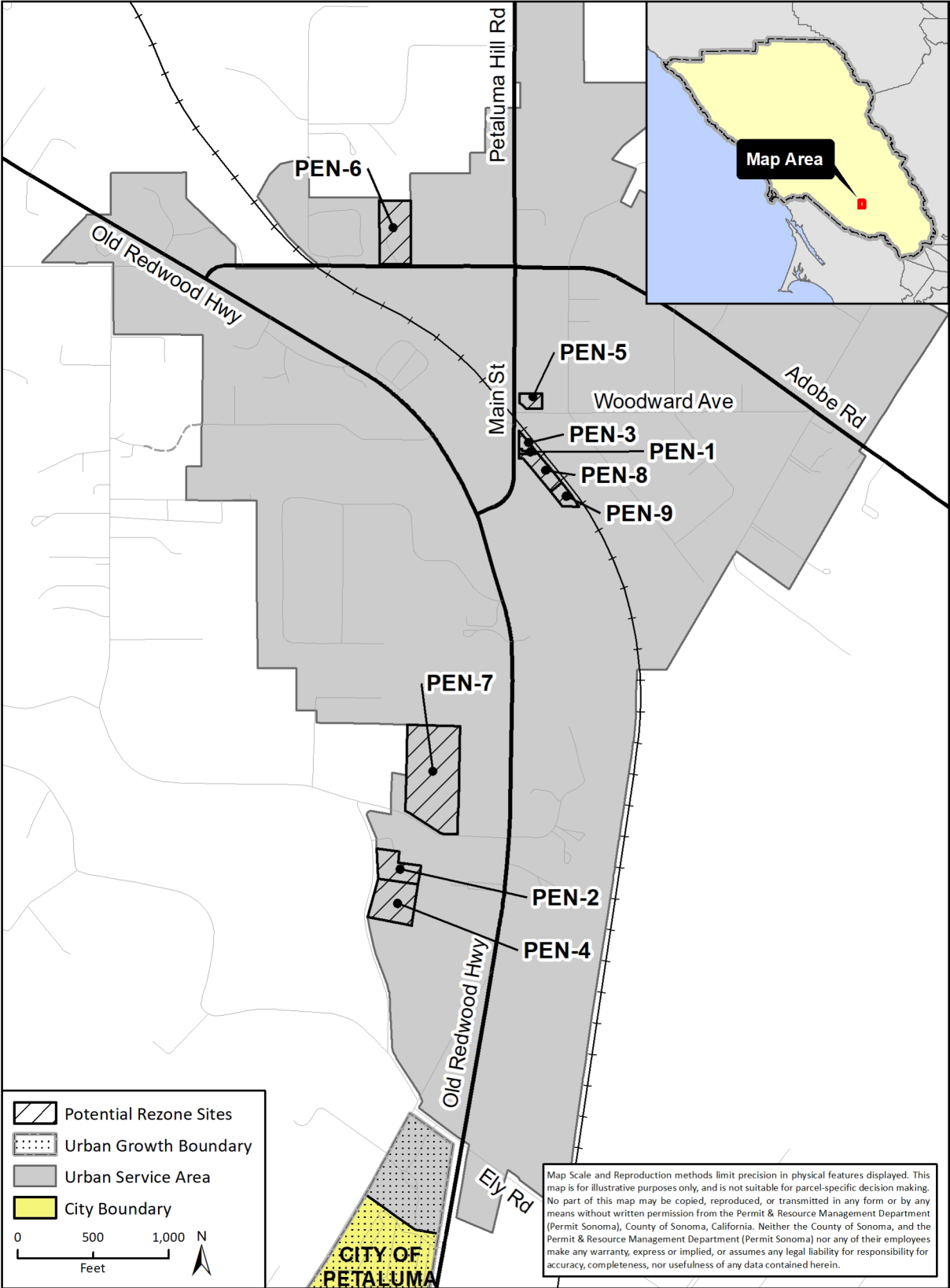
Map Scale and Reproduction methods limit precision in physical features displayed. This map is for illustrative purposes only, and is not suitable for parcel-specific decision making. No part of this map may be copied, reproduced, or transmitted in any form or by any means without written permission from the Permit & Resource Management Department (Permit Sonoma), County of Sonoma, California. Neither the County of Sonoma, and the Permit & Resource Management Department (Permit Sonoma) nor any of their employees make any warranty, express or implied, or assumes any legal liability for responsibility for accuracy, completeness, nor usefulness of any data contained herein.

Source: Modified from data obtained with permission from the County of Sonoma, Permit & Resource Management Department (Permit Sonoma).  
 Data and/or analysis depicted may be altered from the original Permit Sonoma dataset source therefore not representative of Permit Sonoma data; Esri.



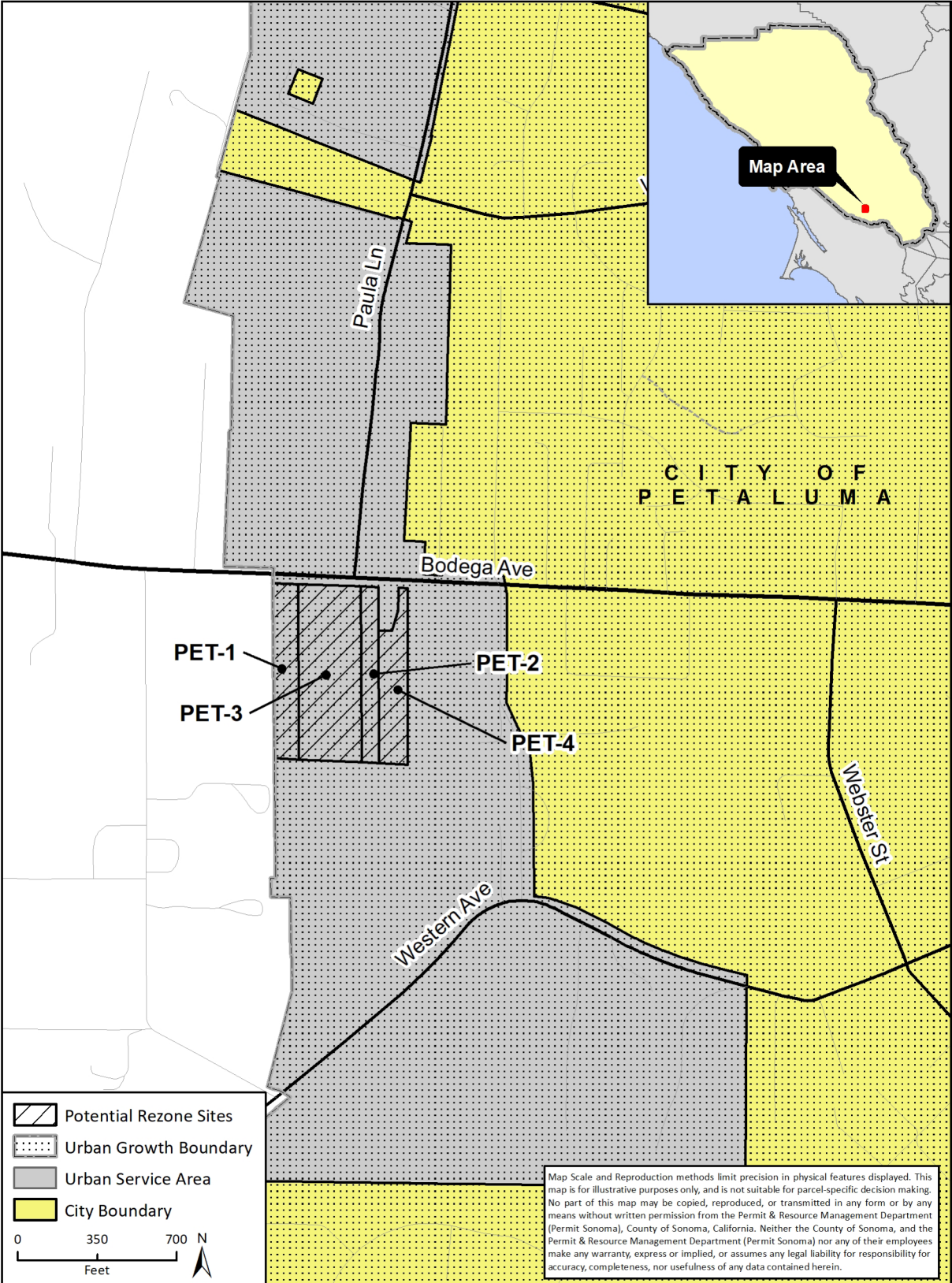


Source: Modified from data obtained with permission from the County of Sonoma, Permit & Resource Management Department (Permit Sonoma). Data and/or analysis depicted may be altered from the original Permit Sonoma dataset source therefore not representative of Permit Sonoma data; Esri.







Source: Modified from data obtained with permission from the County of Sonoma, Permit & Resource Management Department (Permit Sonoma).

Data and/or analysis depicted may be altered from the original Permit Sonoma dataset source therefore not representative of Permit Sonoma data; Esri.



CITY OF  
PETALUMA

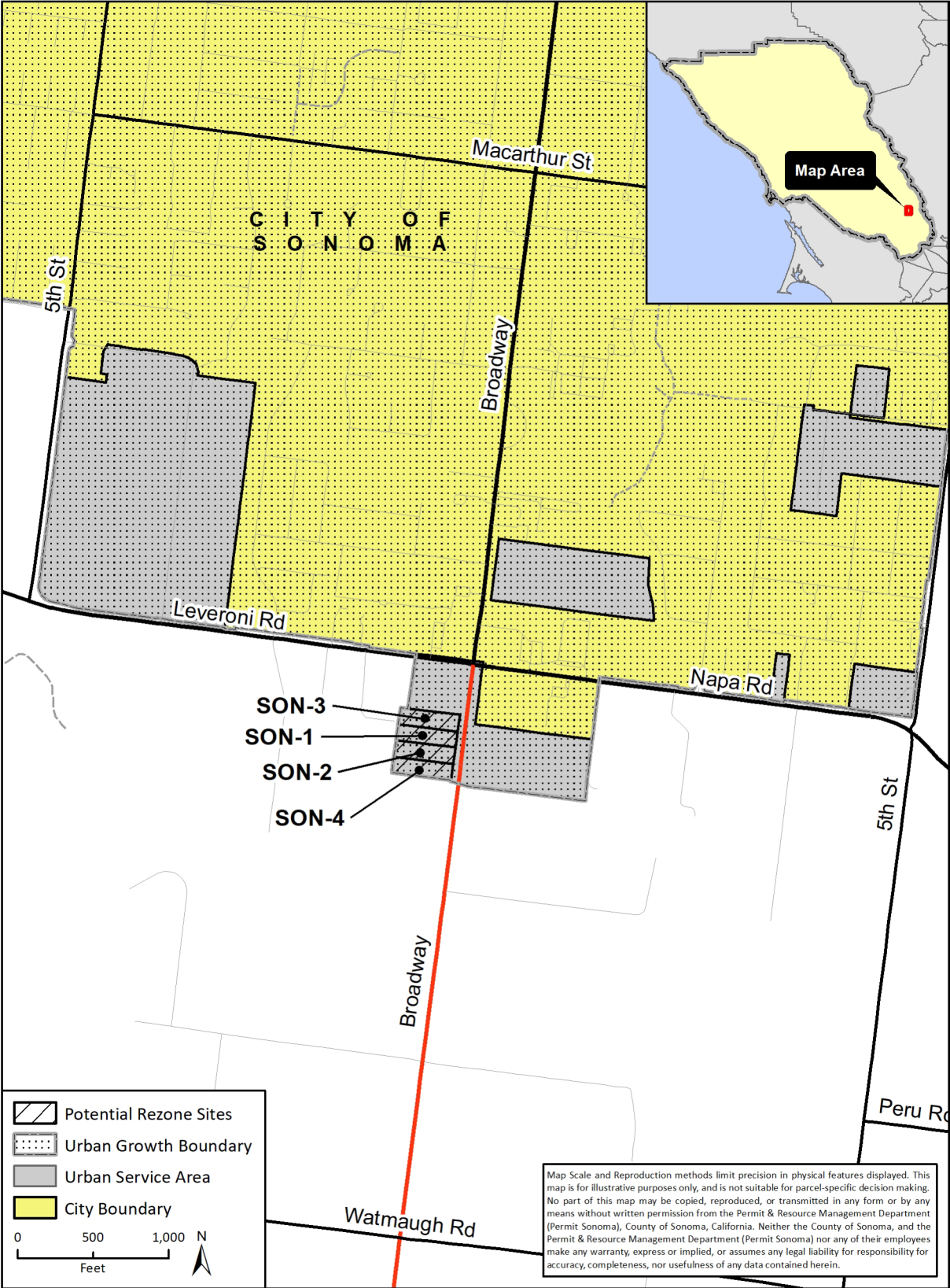
PET-1  
 PET-2  
 PET-3  
 PET-4

-  Potential Rezone Sites
-  Urban Growth Boundary
-  Urban Service Area
-  City Boundary

0      350      700 N  
 Feet

Map Scale and Reproduction methods limit precision in physical features displayed. This map is for illustrative purposes only, and is not suitable for parcel-specific decision making. No part of this map may be copied, reproduced, or transmitted in any form or by any means without written permission from the Permit & Resource Management Department (Permit Sonoma), County of Sonoma, California. Neither the County of Sonoma, and the Permit & Resource Management Department (Permit Sonoma) nor any of their employees make any warranty, express or implied, or assumes any legal liability for responsibility for accuracy, completeness, nor usefulness of any data contained herein.

Source: Modified from data obtained with permission from the County of Sonoma, Permit & Resource Management Department (Permit Sonoma).  
 Data and/or analysis depicted may be altered from the original Permit Sonoma dataset source therefore not representative of Permit Sonoma data; Esri.



Source: Modified from data obtained with permission from the County of Sonoma, Permit & Resource Management Department (Permit Sonoma).

Data and/or analysis depicted may be altered from the original Permit Sonoma dataset source therefore not representative of Permit Sonoma data; Esri.

## **Appendix B – Land Use Summary of Sites Under Consideration**



# Appendix C – Agency Meeting Schedule

AGENCY	REPRESENTATIVE(S)	MEETING DATE
Valley of the Moon Water District	Matthew Fullner	April 20, 2021
	Brian Larson	
City of Sonoma	Chris Pegg	April 19, 2021
California Water Service	Evan Markey	May 5, 2021
California American Water	Margaret DiGenova	-
Penngrove/Kenwood Water Company	Receptionist	-
City of Santa Rosa	Casey Claborn	April 19, 2021
	Caryn Lozada	
City of Petaluma	Kent Carothers	April 20, 2021
Forestville Water District	Tony Lopes	April 20, 2021
Graton Community Services District	Jose Ortiz	May 28, 2021
Sanitation Districts: Geyserville Sanitation Zone Penngrove Sanitation Zone Sonoma Valley County Sanitation District Russian River County Sanitation District Airport/Larkfield/Wikiup Sanitation District South Park County Sanitation District	Kevin Booker	May 10, 2021
	David Royall	



# Appendix D – Reference Documents

USA	Documents for Water	Source	Documents for Sewer	Source
Agua Caliente Glen Ellen	Atlas Maps, Urban Water Management Plan, Water Master Plan	Valley of the Moon Water District	Sewer System Management Plan	Sonoma Water Website
Sonoma	General Plan, Housing Element to the General Plan, Upcoming Infrastructure Projects, Completed Projects, Water Master Plan, CIP	City of Sonoma Website	Sewer System Management Plan	Sonoma Water Website
Forestville	Atlas Maps (in person - no copies allowed)	Forestville Water District General Manager	Atlas Maps (in person - no copies allowed)	Forestville Water District General Manager
Geyserville	Notes from Site Visit and Cal Am	Wood Rodgers	Sewer System Management Plan	Sonoma Water Website
Graton	NA	NA	Atlas Maps	Graton Community Services District
Guerneville	Notes from Site Visit	Wood Rodgers	Sewer System Management Plan	Sonoma Water Website
Larkfield	WSA, Notes from Site Visit and Cal Am	Wood Rodgers	Sewer System Management Plan	Sonoma Water Website
Penngrove	Notes from Site Visit	Wood Rodgers	Sewer System Management Plan	Sonoma Water Website
Petaluma	General Plan, Urban Water Management Plan, CIP Budget	City of Petaluma Website	Sewer System Management Plan, System Map	City of Petaluma Website
Santa Rosa	General Plan, Groundwater Master Plan, Incremental Recycled Water Master Plan, Land Use Diagram, GIS files, Water Master Plan, South Santa Rosa Area Plan, 2015 and 2021 UWMP	City of Santa Rosa Website	GIS files, Sewer System Management Plan, Water System Facilities	City of Santa Rosa Website
Sonoma Water	2015 and 2021 Urban Water Management Plan	Sonoma Water Website	<i>See Individual Zones</i>	<i>See Individual Zones</i>