

Section 13 Non-Standard Experimental and Alternative OWTS Standards

EXPERIMENTAL OWTS STANDARDS

13.1 Bottomless Sand Filter OWTS (Geographical Waiver)

- A. A bottomless sand filter is a special case of an above grade gravel and sand-lined drain field. The process requires intermittent application of wastewater that allows an unsaturated downward flow through a filter media of an ASTM C-33 sand. The purpose of the sand filter is to pretreat the effluent and improve wastewater quality. The use of bottomless sand filters are adequate to allow substantial repairs and renovations to existing residences, provided there is no increase in the volume of sewage discharged.
- B. The site criteria for bottomless sand filter OWTS includes the following:
1. The sand filter will serve an existing structure located on the 100 year flood plain; and
 2. The sand filter will be located at least 100 feet from the summertime banks of the waterway; and
 3. The sand filter will be located on deep, well drained soils without elevated winter time water table levels and will meet all other setback requirements.
 4. Under these conditions, a reduction or elimination of replacement area may be permissible.
- C. The design criteria for bottomless sand filter OWTS includes the following:
1. The design of bottomless sand filters is based on the April, 1999 Washington State Department of Health publication "Sand Lined Trench Systems."
 2. A support structure shall:
 - a. Be designed and built so that the top of the liner is at least 6 inches above natural grade.
 - b. On sloping sites a surface water diversion must be excavated upslope of the sand filter at the top of the sand filter backfill material.
 - c. The containment vessel must be designed by a qualified engineer and have a support foundation to prevent vertical and horizontal movement of the vessel.
 3. The bottomless sand filter must be installed into a minimum of 6 inches of native undisturbed soils and consist of the following components:
 - a. 24 inches of ASTM C-33 sand filter media, as determined by ASTM D-136 and C-177;
 - b. A distribution bed consisting of 6 to 12 inches of gravel bed with pipe;
 - c. An approved geo-textile followed by 6 to 12 inches of earth backfill.
 4. Effluent distribution from the sump to the sand filter shall be:
 - a. Pressure transport. Manifold, lateral piping and fittings must be at minimum Schedule 40 PVC.
 - b. Pressure transport piping shall be solvent welded. All joints in the manifold piping, lateral piping, and fittings must be solvent welded and watertight.

- c. A gate valve and check valve must be placed on the pressure transport pipe, in or near the sump tank, as appropriate.
- d. Pressure lateral distribution piping and fittings must be a minimum of 1 inch in diameter.
- e. Pressure manifold and transport piping must be a minimum of 2 inches in diameter.
- f. Hydraulic orifice discharge shall be a minimum of 60 inches for upward discharge. Orifices shall have a protective shield.
- g. Orifices must have a minimum 1/8-inch diameter and be placed a maximum distance of 30 inches apart.
- h. Ends of the lateral distribution piping must be connected with a blow off riser for cleaning and inspecting. The riser shall extend to the ground surface and have a threaded cap.
- i. The distribution lateral shall have 6 or 12 inches of gravel beneath the pipe (residential and commercial respectively), 2 inches of gravel above the pipe and be covered with an approved geo-textile filter prior to placement of 6 to 12 inches of soil cover.
- j. The sand filter maximum dosage is 90 gallons per cycle. Electronic timed meters are preferred over float (on demand) type controls.

D. The construction criteria for bottomless sand filter OWTS includes the following:

- 1. Wooden containment vessels shall be constructed of pressure treated or redwood heart grade materials.
- 2. The sides of the above ground containment vessels shall be lined with a minimum thickness 30 millimeters PVC membrane liner.
- 3. The liner must extend up the sides of the support structure with enough excess to allow the liner to be firmly anchored.
- 4. All seams shall be factory heated or solvent welded.
- 5. A factory fabricated boot where the pressure line passes through the liner is required. The boot must extend into the box. All fittings must extend into the liner and be watertight.
- 6. Use of a non-woven needle punched synthetic geo-textile fabric in a thickness appropriate to protect the liner is required.
- 7. Both the filter media surface and the sand-original soil interface must be level.

E. The performance well criteria for bottomless sand filter OWTS includes the following:

- 1. 1 or more performance wells shall be installed 10 feet upslope of the sand filter to a depth of 24 inches below grade.
- 2. 1 or more performance wells shall be installed 10 feet down slope of the sand filter to a depth of 24 inches below grade.
- 3. If the hydraulic gradient cannot be determined on flat sites, performance wells will be required on each side of the sand filter. 1 well shall be installed 25 feet upslope and 1 well installed 25 feet down slope of the sand filter. The depths of the wells shall be a minimum of 24 inches below grade.
- 4. On sloping sites, 1 or more performance wells shall be installed 25 feet down slope of the sand filter to a depth of 24 inches below grade.

5. 1 or more performance wells shall be installed in the sand filter to a depth of the upper gravel and sand interface.
6. 1 or more performance wells shall be installed in the sand filter to a depth of the lower sand and gravel interface. See Figure 11.6.

13.2 Gravel-less Pressurized Dispersal Channel (GPDC)

A. Gravel-less Pressurized Dispersal Channel (GPDCs) OWTS are designed for subsurface dispersal of high-quality effluent after secondary treatment. There are 2 typical configurations. 1 consists of perforated laterals laid in a 12-inch wide infiltration channel, covered with sections of plastic half-pipe and shallowly buried in native soil. The other uses an 18-inch infiltration channel and sections of 8-inch low-profile HDPE chamber material.

B. The site criteria for GPDC OWTS includes the following:

1. Depth to a limiting condition and permeable soils (1 to 120 minutes per inch) below the dispersal line shall be a minimum of 24 inches.
2. The soil above the PVC line proposed depth shall be permeable (1 to 120 minutes per inch). This excludes massive or platy structured soils. Soils subject to flooding, excessive irrigation, farming practices, grading, ripping or roto-tilling are also not acceptable. The quality of acceptable soils above the line shall be equal to those below the line.

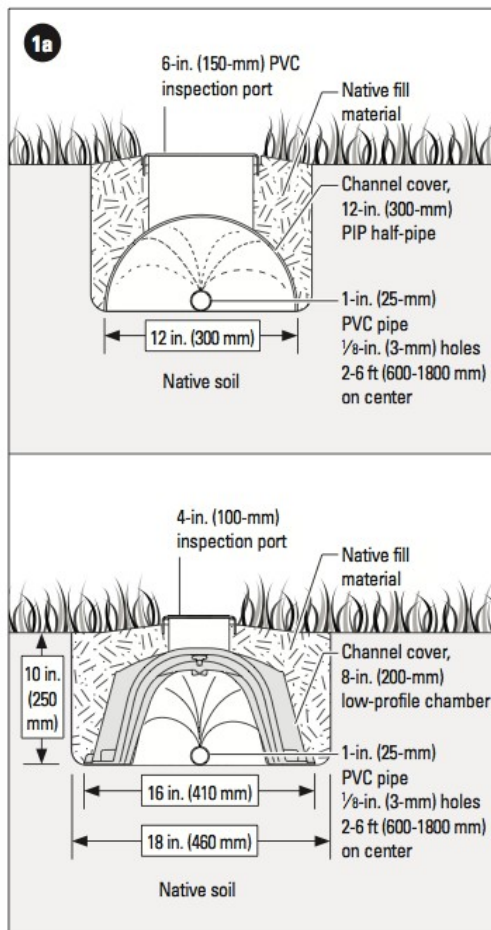

3. A minimum of 24 inches of permeable soil below dispersal depth shall extend a horizontal distance of no less than 25 feet down gradient from the edge of the last proposed line, including expansion areas.

4. GPDC sites shall not exceed 30 percent slope without an approved waiver and a geotechnical study required for slope stability and suitability.

5. GPDC sites shall not exceed 25 percent slope when fill is placed over the dispersal system.

C. The design criteria for GPDC OWTS includes the following:

1. Separation between laterals shall be a minimum of 3 feet.

2. GPDC installations space orifice holes 24 inches minimum to 72 inches maximum on center.

3. A GPDC System is typically installed 10 inches into native soil. A minimum native soil depth of 6 inches may be allowed with disinfection. The minimum soil cover over the orifice shield is 2 inches. The maximum soil cover allowed is 18 inches. (See Illustration 1a.)

Cross sections of typical half-pipe and low-profile SPDS installations showing dimensions and materials

4. The designer shall also determine the number of zones, the number of doses, the quantity of the dose, the head losses, spacing of lines, spacing of orifices, diameter of the pipe (typically 1 inch PVC), and pump size.
5. The length of each dispersal line shall not exceed 75 feet to ensure equal distribution to each orifice. If multiple zones are designed, dosing must be automatically alternated between each zone.
6. All GPDC Systems require an approved packed bed media filter supplemental treatment unit for treating septic effluent. The level of supplemental treatment must comply with NSF Standard 40 or to the satisfaction of the Permit Authority.
7. Designer shall employ measures to prevent uneven distribution of the dispersal field due to drain down following a pump cycle. Per California Plumbing Code, spring check valves are not allowed for wastewater applications.
8. Provide 2 feet of solid pipe between the manifold and the first orifice.
9. At the end of each lateral, install a sweep ell (or two 45 degree elbows) and a ball valve with a threaded plug.
10. All system components shall be appropriately sized for the system dosing flow rates, and shall meet specifications of the manufacturer. All transport piping, supply and return manifolds and fittings must be Schedule 40 PVC or Schedule 80 PVC if threaded fittings are utilized. All filters must be sized to operate at a flow rate greater than or equal to the maximum design discharge rate of the system.

11. All GPDC System designs shall demonstrate that sufficient suitable area exists to construct 200 percent reserve area. Because GPDC Systems are experimental, in cases of split system designs, the GPDC System shall be installed as the primary system, and the other type of dispersal system shall be the 200 percent expansion system.

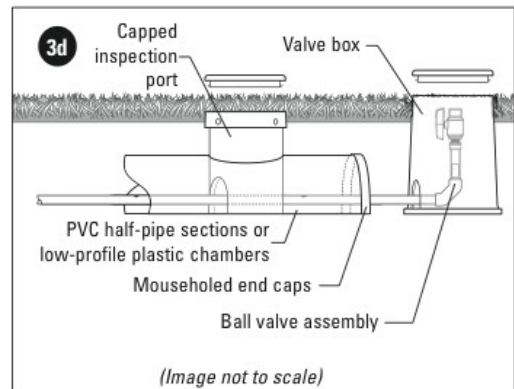

12. Totalizing flow meters (in gallons) are required on the supply line. Flow meters must be installed in a readily accessible location for reading and servicing.

13. A controller capable of timed dosing is required.

14. Disinfection of the treated wastewater shall be incorporated in cases of well-drained soils (less than 1 minute per inch or faster) or where dispersal systems only have a minimum of 6 inches of native soil cover above the shield (see Illustration 3d). If 6 inches of approved fill is added above the 6 inches of native soil cover, disinfection will not be required.

15. For aerobic treatment unit (ATU) systems that function with external blowers, a cutoff switch or interlock that disables the pump must be built into the control panel so the blower may not be disconnected.

D. Construction criteria for GPDC OWTS includes the following:

1. Construct trenches with special attention to proper elevation and contour.

- a. Shallow trenches can be dug (by hand or with a trenching machine).
 - b. Trenches shall not be installed when the soils are wet or in an excessively damp state.
 - c. Sidewall of trenches shall be scarified to remove all smears.
 - d. Install perforated piping, placing orifices upwards for the hydraulic test.
 - e. Trenches can be straight, or they can be curved to fit terrain and complement vegetation, but they must be set on level grade.
 - f. Lay the half-pipe (or low-profile chamber) sections over the laterals, overlapping the section ends by a few inches. For covering curving laterals, half-pipe section ends can be cut at an angle and overlapped to match the curve of the lateral. Install 1 inspection port halfway along each lateral (see Illustration 1a).
 - g. All GPDC shall be protected from gopher soil movement.
2. Valves must be readily accessible for service and/or inspection. All valve boxes must be protected from gopher soil movement. A detail of the valve box must be included on the plans. Specify concrete, hardware wire or similar bottom.
 3. Perform hydraulic test after the distribution system has been completed.
 - a. Size of orifice shall be 1/8 to 3/16 of an inch.
 - b. Pump must be adequate to deliver the required orifice discharge range of 24 (3/16 hole) and 60 inches (1/8 hole) for upward discharge to the lateral.
 - c. Distribution to all laterals shall be balanced.
 - d. This test shall be inspected by the designer/consultant and Permit Authority REHS.
- E. Establish the finished grade of the GPDC OWTS by track rolling and grooming by hand. Backfill the excavation with caution. Do not compact the soil around the half-pipe or chamber.
- F. Fill material may only be placed above native soil for soil cover, and shall not be used to meet required soil depth minimums. The system designer shall describe the type of fill to be placed in terms of texture and structure, and the depth and method of ripping before placement. No part of the GPDC dispersal field may be located where the site slope exceeds 25 percent when fill is used.
1. A ground cover (turf, fruit trees or other appropriate landscaping) must be planted over the dispersal field after installation to provide additional treatment, prevent erosion and increase wastewater reuse through plant evapotranspiration.
 2. Native material is acceptable if there are no large or sharp rocks that may damage the pipe walls. If native material is not usable, backfill with sand or pea gravel, or use an imported material that is approved by your local Permit Authority.
 3. Install performance wells and complete all details as shown on the plans.
 4. After the final electrical inspection of the associated building/electrical permit is approved by the Building Inspector, a startup inspection must be scheduled with the system designer, installer, or service provider and the Permit Authority Well and Septic Section staff.
 5. Prior to OWTS final approval, acceptable erosion control must be completed.
- G. The performance well criteria for GPDC OWTS includes the following. A minimum of 5 performance wells shall be installed within and around the system to a depth of 24 inches below proposed trench bottom. (See Figure 11.6.)
1. Two performance wells shall be installed between trenches in the middle of the leachfield.

2. Two performance wells shall be installed 25 feet down slope of the lowest trench line.
3. One performance well shall be installed at 10 feet upslope of the highest trench line.
4. Additional performance wells may be required for systems longer than 75 feet.
5. The Permit Authority may require that performance well locations be changed in special situations.
6. Performance wells shall be properly installed to provide easy access.

ALTERNATIVE OWTS STANDARDS

13.3 Mound OWTS

- A. Mound OWTS are based upon the Small Scale Waste Management Project, University of Wisconsin at Madison, *Wisconsin Mound Soil Absorption System Siting, Design and Construction Manual*, by James C. Converse and E. Jerry Tyler, January 2000. Mound systems are designed to overcome restrictive conditions for soil permeability and depth to groundwater below the bottom of the system. Designers shall use the same methodology and nomenclature as the most recent *Wisconsin Mound Soil Absorption System Siting, Design and Construction Manual*.
- B. The site criteria for Mound OWTS includes the following:
1. Percolation rate of 1 to 120 minutes per inch
 - a. Percolation rate requirements apply to the first 24 inches of soil as measured from native grade. See Section 7.
 - b. Presoak remaining in 24 inch deep percolation test holes may indicate lack of soil depth.
 - c. Rates faster than 1 minute per inch are not acceptable.
 2. Minimum elevated groundwater level is 24 inches from native grade.
 3. Minimum depth of suitable permeable soil is 24 inches from native grade.
 - a. The rock content (as retained on the #10 Sieve) shall not exceed 50 percent by volume within the first 24 inches of soil from native grade.
 - b. The minimum depth to fractured rock, impermeable soils, such as hardpans and claypans, and consolidated bedrock is 24 inches.
 - c. The addition of an approved pretreatment unit does not mitigate 1 foot of the required minimum 24 inches of suitable soil beneath the mound. 2 feet of acceptable native soil from native ground is required.
 4. The minimum depth of permeable soil (24 inches) shall extend a minimal horizontal distance of at least 25 feet down gradient from the edge of the sand perimeter.
 5. Mound systems are allowable on slopes up to 20 percent.
 6. Placement of mound OWTS into areas that require the removal of large trees, boulders, or rock outcroppings is not recommended.
- C. The design criteria for mound OWTS (see Figures 13.3a and 13.3b) includes the following:

1. Wastes with a high biological oxygen demand are not suitable for mound systems without approved pretreatment sufficient to lower the waste strength to the level of that septic tank effluent as specified in Section 13.8.
2. Distribution (Gravel) Bed
 - a. Sand Fill Loading Rate
 - i. 1.0 gallon per square foot per day for residential type systems
 - ii. 0.8 gallons per square foot per day for all commercial type systems
 - iii. Reduced loading rates for high strength waste may be required.
3. Linear Loading Rate
 - a. Designers shall estimate the linear loading rate for all proposed mound OWTS and shall design the width dimensions of the gravel bed accordingly, so that the distribution bed is long and narrow and on the contour.
 - b. When the depth to a limiting condition, for example, impermeable soil layer or rock is only 24 inches, the linear loading rate shall not exceed 4 gallons per lineal foot per day.
 - c. If it can be demonstrated that the wastewater flow will be vertical, as well as horizontal, a higher loading rate may be proposed.
 - d. Refer to Table 13.3a and Figure 13.3a for the Linear Loading Rates based on Limiting Conditions.

Table 13.3a – Linear Loading Rates (LLR) Based on Limiting Conditions

Nature of Limiting Condition	LLR Range (gpd/linear ft)
Solid Bedrock	3-4
Impermeable Soil Layer	3-4
Semi-Permeable Soil Layer	5-6
Fractured Compacted Till	5-6
Seasonal High Water Table	6-8
Crevice or Fractured bedrock	8-10
Sand and/or Gravel Layer	8-10

Figure 13.3a – Linear Loading Rate

Mound System overlaying a permeable soil lens over creviced bedrock. Estimated linear loading rate equals 8 to 10 gallons per day per linear foot.

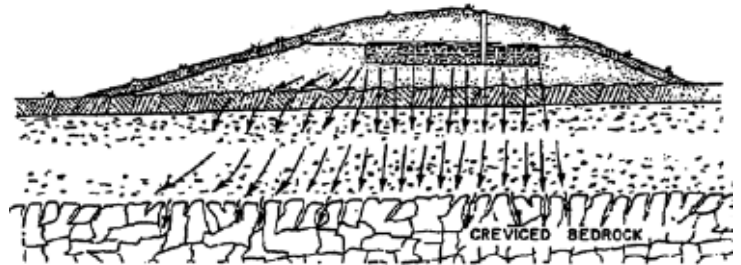

Mound System overlaying a deep permeable soil lens over a fluctuating water table. Estimated linear loading rate equals 6 to 8 gallons per day per linear foot.

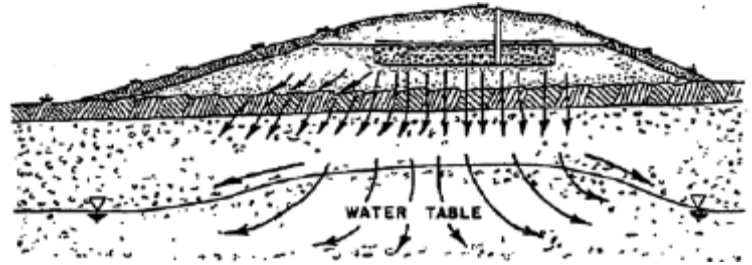

Mound System overlaying a shallow permeable soil lens over a semi-permeable soil layer. Estimated linear loading rate equals 5 to 6 gallons per day per linear foot.

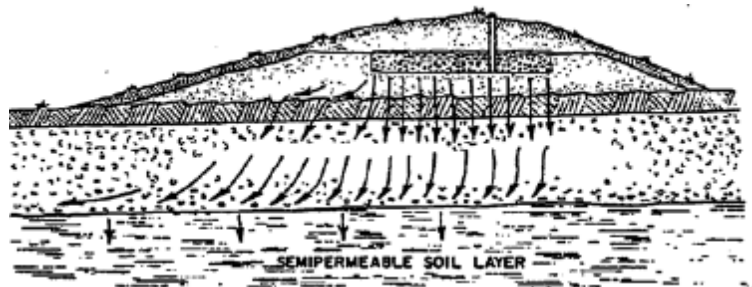

Mound System overlaying a shallow permeable soil lens over an impermeable soil layer. Estimated linear loading rate equals 3 to 4 gallons per day per linear foot.

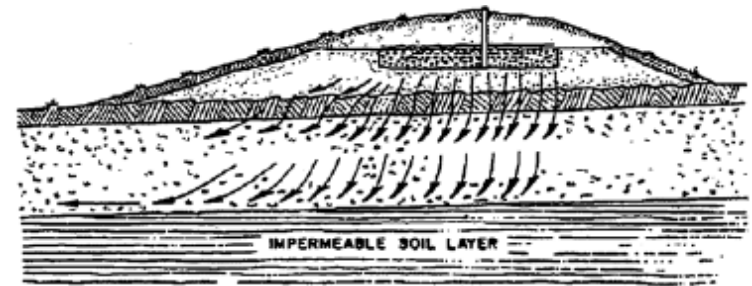

4. Infiltration Area (Dispersal Bed)

a. Sizing calculations for all mound dimensions shall be provided with all proposals. Refer to Figures 13.3a and 13.3b. The size of the infiltration area (the bottom infiltrative surface area of the bed) is determined by applying the following formula

- i. Infiltrative Surface Area (square feet) equals Daily Design Flow (gallons per day) divided by Sand Fill Loading Rate

Figure 13.3b – Mound Cross Section

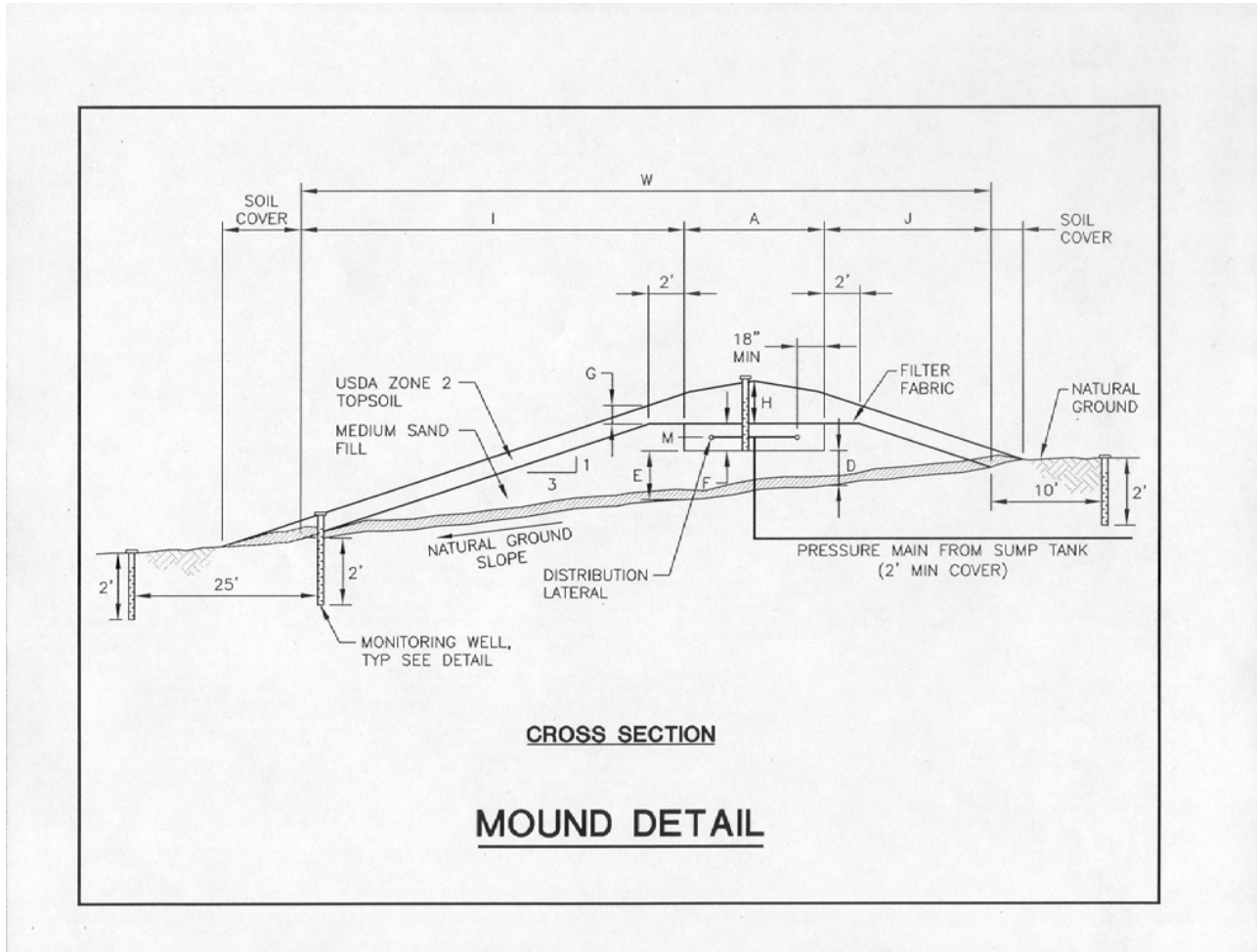
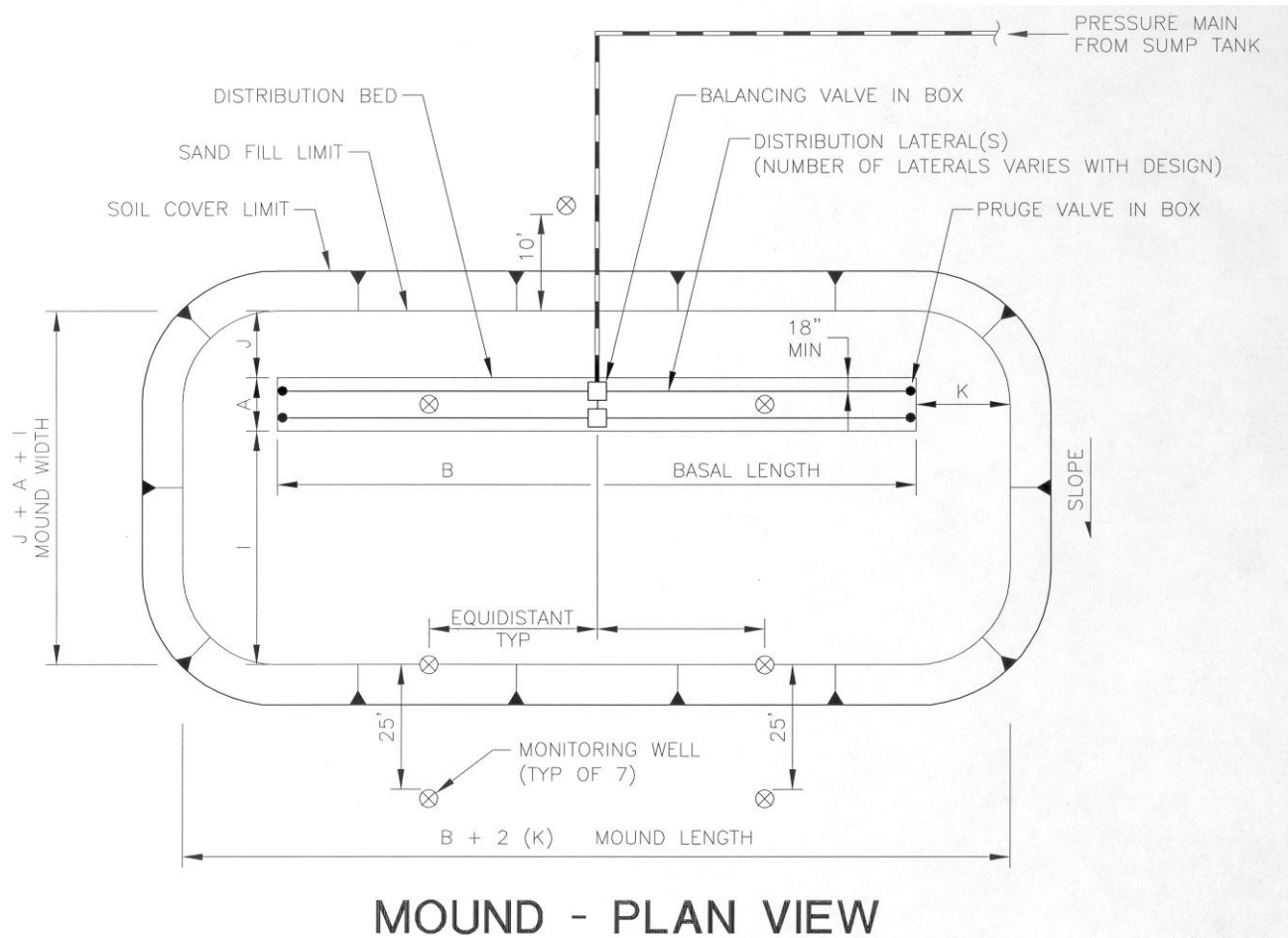

Figure 13.3c – Mound Plan View



- b. Dispersal Bed Width—The dispersal bed width (A) is determined by the Linear Loading Rate of certain soil type and depth. Linear Loading Rates are shown in Table 13.3a and Figure 13.3a. Maximum bed width shall be 10 feet.
- i. Dispersal Bed Width (A) equals Linear Loading Rate divided by Sand Fill Loading Rate
- c. Dispersal Bed Length— The length of the infiltration area (the infiltrative surface area of the dispersal bed) is determined by applying the following formula
- d. Dispersal Bed length (B) equals Required Infiltrative Surface Area divided by Dispersal Bed Width (A)
- Dispersal Bed Depth (F)—A minimum of 6 inches of aggregate for residential and 9 inches for commercial systems is placed beneath the distribution pipe and 2 inches of aggregate is placed above the pipe.
- i. Dispersal Bed Grade—The bottom of the dispersal bed must be level.
 - ii. Filter Media Depth—The depth of filter media shall be at least 12 inches under all parts of the dispersal bed.
 - iii. The depth of filter media below the dispersal bed varies with ground slope according to the following formulas
 - iv. Filter media depth below upslope edge of dispersal bed (D) equals 1 foot.
 - v. Filter media depth below downslope edge of dispersal bed (E) equals 1 foot plus [percentage natural slope as a decimal times the width of dispersal bed (A)]

- e. Filter Media Length and Width—The length and width of the filter media are dependent upon the length and width of the dispersal bed, filter media depth and side slopes of the filter media.
- f. Side slopes must be no steeper than 3 to 1 (for example 3 feet of run to every 1 foot of rise).
- g. The filter media length consists of the end slopes (K) and the dispersal bed length (B).
- h. The filter media width consists of the upslope width (J), the dispersal bed width (A), and the downslope width (I). On sloping sites, the downslope width (I) will be greater than on a level site if a 3 to 1 side slope is maintained. Table 13.3b gives the slope correction factor (multiplier) for slopes from 0 up to 20 percent with a 3 to 1 side slope.
- i. The sand fill shall be level and extend a minimum of 24 inches horizontally beyond the dispersal bed on all sides, and then uniformly slope as determined by the mound dimensions. On slopes greater than 2 percent, the 24 inch dimension may be reduced to 12 inches on the uphill side of the distribution bed.
- j. Slope Width and Length of the Mound System
 - i. For sloping sites the downslope width (I) and upslope width (J) are a function of the depth of the sand fill below the respective downhill or uphill side of the dispersal bed, the desired side slope, 3 to 1, and the slope correction factor. See Table 13.3b.
 - ii. For level sites and end slope length (K), no slope correction factor is used.
 - iii. Upslope width (J) equals (D plus F) times 3 (slope correction factor)
 - iv. Downslope width (I) equals (E plus F) times 3 (slope correction factor)
 - v. End slope length (K) equals {(D plus E) divided by 2 plus F} times 3.

Table 13.3b – Mound Slope Correction Factors

Slope Percentage	Downslope (I) Correction Factor	Upslope (J) Correction Factor
0	1	1
2	1.06	.94
4	1.14	.89
6	1.22	.86
8	1.32	.80
10	1.44	.77
12	1.57	.73
14	1.72	.71
16	1.92	.68
18	2.17	.65
20	2.50	.62

- k. Basal Area Calculation—The amount of sand basal area required is dependent upon the permeability of the original soil.
 - i. For level sites the total basal area [length of filter media (L) times width of filter media (W) beneath the filter media is available for effluent absorption into the soil.
 - ii. For sloping sites, the only available basal area is the area beneath the dispersal bed (A times B) and the area immediately downslope from the dispersal bed [bed length (B) times downslope width (I)]. It includes the area enclosed by [B times (A plus I)]. The upslope and end slopes will transmit very little of the effluent on sloping sites, and are therefore disregarded.
 - iii. The available basal area must equal or exceed the required basal area (aa) Basal area required equals Daily flow divided by Soil Infiltration rate (bb) Basal area available equals B times (A plus I plus J) on level sites or B times (A plus I) on a sloping site.

5. Configuration
 - a. Only single distribution beds are acceptable. Dual beds are not allowed.
 - b. The maximum width of any gravel bed is 10 feet.
 - c. The depth of the gravel bed shall be 6 inches below the pipe for residential systems and 9 inches for commercial systems and include 2 inches of gravel cover over the pipe.
6. Aggregate
 - a. 3/8 inch double washed pea gravel size to 2.0 inch double washed drain rock
 - b. The percentage of fines (less than .035 millimeters) of washed gravel shall not exceed 1 percent by weight
7. Natural Contour
 - a. The distribution bed shall explicitly follow the natural contour of the ground
 - b. The bed must be installed within a tolerance of 0.25 feet (3 inches) vertically per 100 feet horizontally.
 - c. Distribution beds shall be angled or curved to meet this requirement.
 - d. The distribution bed shall not be placed in a concave landscape position.
8. Reserve Expansion Area
 - a. On parcels created before October 1971, a 100 percent reserve area is required.
 - b. For commercial systems and parcels created after October 1971, a 200 percent reserve area is required.
9. Sand Fill (Basal) Area
 - a. The sand-fill (basal) area, shall, at a minimum, provide adequate basal (absorption area). The sand area size is based upon the average percolation rate and the sewage application rate chart. See Table 7.2a.
 - b. Sand fill media shall conform to the ASTM C-33 sand with less than 5 percent fines less than 0.53 millimeter sand specification to Wisconsin mound criteria (see Table 13.3c and Figure 13.3d).

Table 13.3c – Mound Sand Specification

Sieve Size Number	Percent Passing
3/8	100
4	95-100
8	80-100
16	50-85
30	25-60
50	10-30
100	2-10
200	0-5

Figure 13.3d Mound Sand Criteria

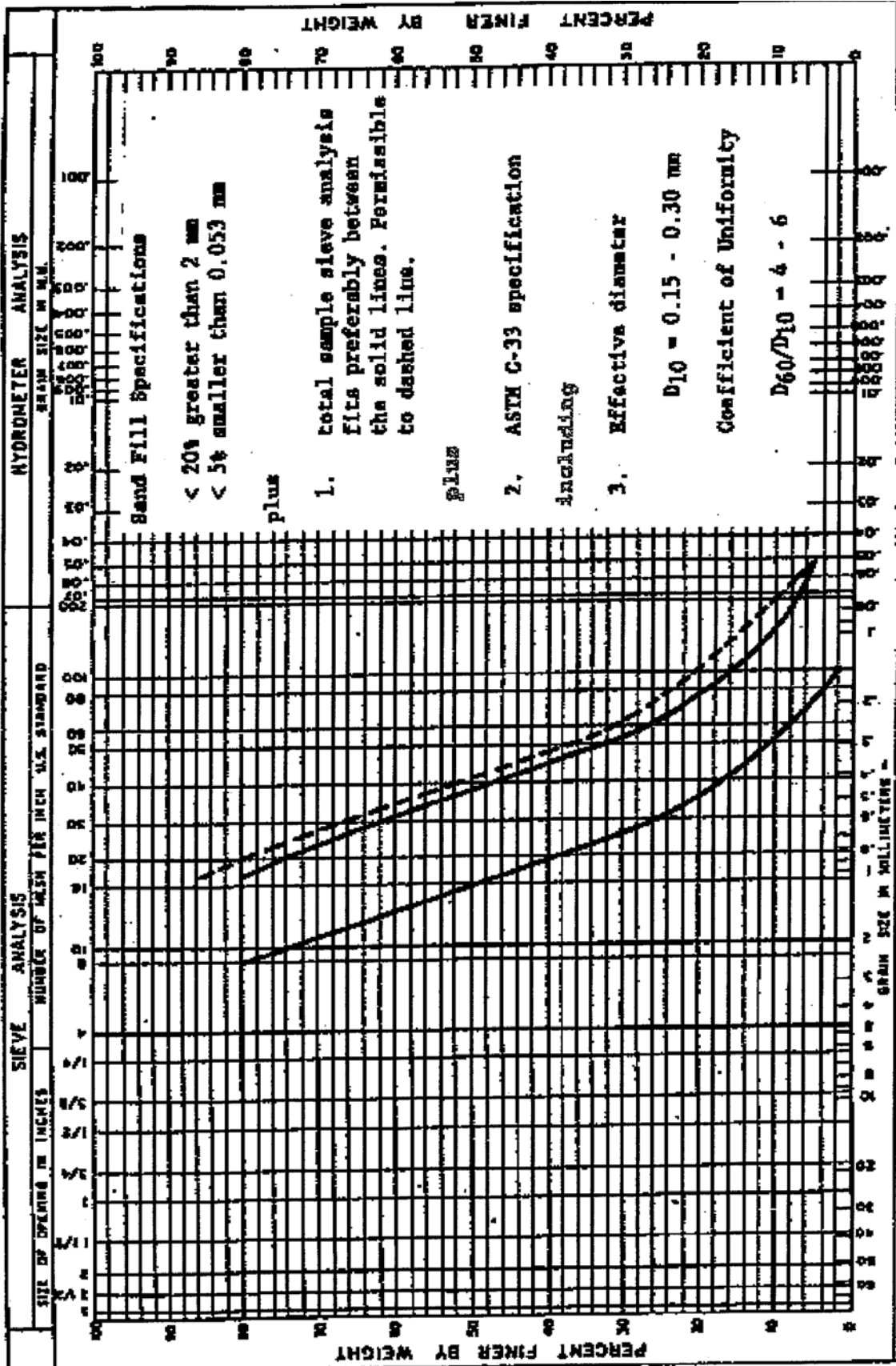

- c. For ground slopes greater than 1 percent, the area uphill from the edge of the gravel distribution bed shall not be included in the calculations for the required basal area.
- d. Areas beyond the distal end of the gravel bed shall not be included in the calculations for the required basal area for systems exceeding 1 percent slope.

10. Configuration

- a. The toe of the sand fill shall follow contour, and shall not deviate more than 0.25 feet (3 inches) in elevation per 100 foot run.

Figure 13.3e – Contour Conformance

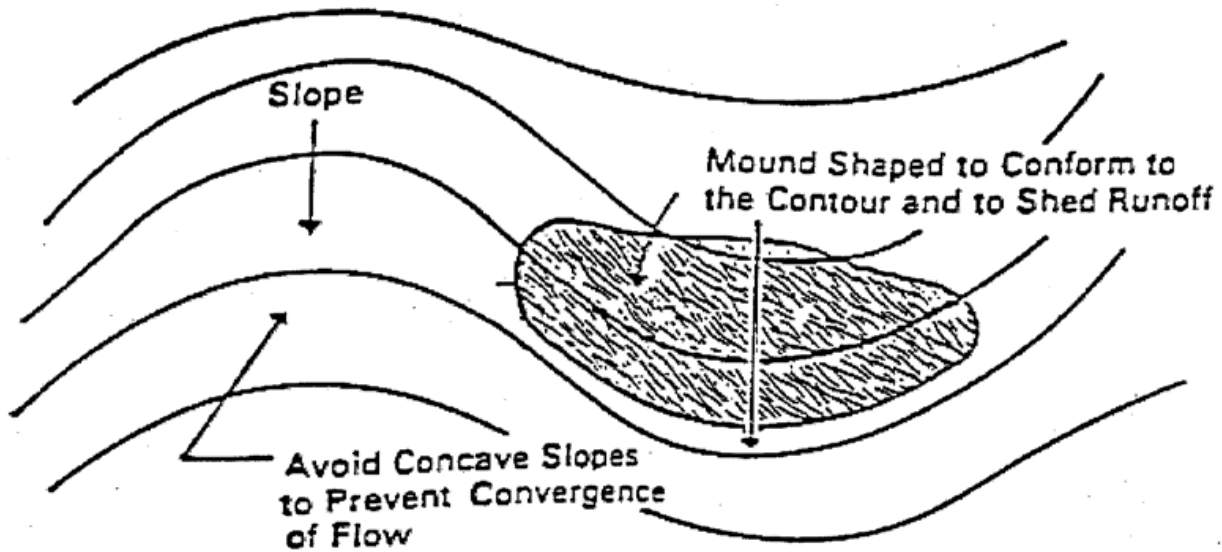

- b. The sand fill configuration shall extend a minimum of 24 inches level from the edge of the distribution bed on all sides, then uniformly slope as determined by the mound dimensions. On the slopes greater than 2 percent, the 24 inch dimension may be reduced to 12 inches (minimum) on the uphill side of the distribution bed only.

11. Soil Cover

- a. A minimum of 6 inches in depth after settling over the gravel bed portion of the mound and over the remainder of the sand portion.
- b. Mounded to a height of 12 inches after settling at the midsection of the gravel bed.
- c. The distal ends and uphill sides soil cover width requirements are 4 feet
- d. Downslope soil cover shall conform to Table 13.3d.
- e. The quality of the soil structure and texture (USDA Classification) shall be at least equal to that of the topsoil existing on the site.

Table 13.3d – Mound/At-Grade Downslope Soil Cover Requirements

Slope Percentage	Cover (lineal feet)
0-2	4
2-4	6
4-6	8
greater than 6	10

12. Distribution System

- a. Designers shall calculate the total dynamic head loss of the entire distribution systems.
 - i. Vertical differences
 - ii. Length of entire piping system
 - iii. Loss of all valves, tees, elbows, and appurtenances
 - iv. Head Loss shall be referenced as feet of elevation
 - v. Hydraulic orifice discharge shall be a minimum of 60 inches for upward discharge. Orifices shall have a protective shield.
 - vi. Orifice spacing shall be a maximum of 36 inches on center. (Closer spacing is preferred.)
 - vii. Size of orifice shall be 1/8 to 3/16 of an inch.
- b. System distribution manifolds shall have a balancing valve at the beginning of each perforated pressurized line and a purge valve at the end.
 - i. All valves shall be protected and encased within plastic, concrete or other approved type box to provide easy access and maintenance. Metallic valves are prohibited.
 - ii. Box size shall be 10 inches across or larger, round or square, and must allow enough room for maintenance and/or to install stand pipes onto the ends of the purge valves
 - iii. Balancing valves shall be PVC Schedule 40 or higher gate valves.
 - iv. Purge valves shall be PVC Schedule 40 or higher gate or ball type valves.
 - v. Valve boxes shall be placed on screen blocks or equivalent and shall be designed, installed, and maintained so as to prevent soil and rodent intrusion into the box. See Figures 13.3f and g.

Figure 13.3f – Balancing Valve

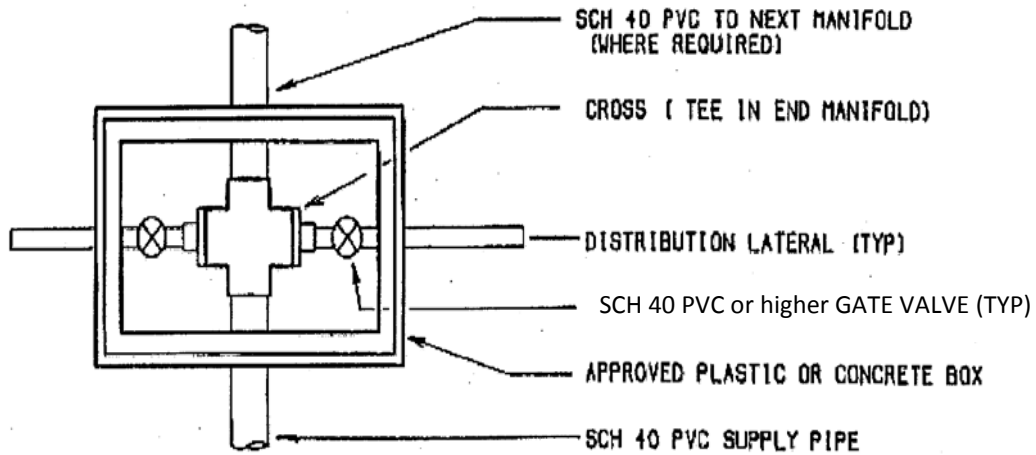

PLAN VIEW
BALANCING VALVE DETAIL

Figure 13.3g – Purge Valve

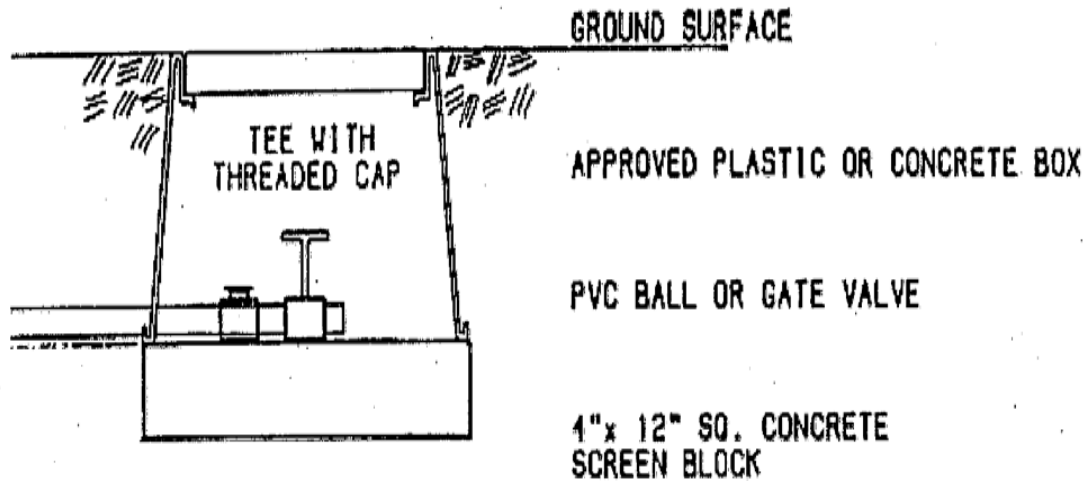

PURGE VALVE DETAIL
NTS

- c. Spacing of pressurized lines shall be based on gravel bed width.
 - i. A Gravel bed width of 3 to 4 feet allows 1 pressurized line
 - ii. A Gravel bed width of 4 to 6 feet allows 2 pressurized lines
 - iii. A Gravel bed width of 6 to 8 feet allows 3 or 4 pressurized lines
 - iv. A Gravel bed width of 8 to 10 feet allows 4 or 5 pressurized lines
- d. Distribution piping shall be Schedule 40 PVC or greater of at least 3/4 inch diameter.
- e. Maximum length of pressurized lines shall be 75 feet.
- f. Maximum distance between perforations shall be 36 inches.
- g. Perforations shall be directed upward and must be protected with a shield.

13. Sump and Pump

- a. Refer to Sections 8.3 and 8.4 for required sump and pump features.
 - i. Automatic dosing siphons are not allowed in mound sewage dispersal systems.

D. The construction criteria for Mounds includes the following:

1. These specifications must be included in the system plans submitted with the Permit Authority. The use of wheel type vehicles is prohibited,
 - a. For the purpose of ripping
 - b. When driving on any areas that have been ripped
 - c. When driving on the sand fill
 - d. When placing or moving the soil cover
 - e. At any time that soil conditions are wet, moist, or saturated.
2. Placement of the pressurized transmission line from the sump tank to the mound manifold shall be a minimum of 24 inches below the surface of the ground.
3. Site preparation of soil surface to a depth of 8 to 12 inches.
 - a. Mow excessive vegetation.
 - b. Remove trees.
 - c. Cut and grind stumps to a depth of 12 inches.
4. Perform initial ripping parallel to the contours of the ground within the limits of the sand base; rippers set 8 to 10 inches apart.
5. After all the sand has been placed and prior to mound soil cover placement, rip the native soil that will interface with the mound soil.
6. Prohibit all traffic on any ripped surfaces until the full depth of fill or cover material has been placed.
7. Uniformly place and compress the sand fill by track rolling a neat line to the grade determined by the mound dimensions. A tolerance of no more than 0.25 feet (3 inches) vertically, to 100 feet horizontally is allowed. Add additional sand as the sand fill area is compressed.
8. Construct gravel bed with special attention to proper elevation
 - a. Temporary form boards are required for placement of the distribution bed gravel.

- b. Form boards shall be fully enveloped by the sand bed and shall be removed prior to cover placement.
9. Perform hydraulic test after the distribution has been completed.
 - a. Hydraulic orifice discharge shall be a minimum of 60 inches for upward discharge.
 - b. Orifices shall have a protective shield.
 - c. Distribution to all laterals shall be equal.
 - d. This test shall be inspected by the consultant and the Permit Authority staff.
 10. Condition soil cover material with sufficient moisture to allow track rolling to a firm cohesive surface.
 11. Establish the finished grade of the mound by track rolling and grooming by hand.
 12. Complete proper drainage work and erosion control measures before final inspection.
 13. Install monitoring wells and details as shown on the plans.
 14. Prior to septic system final approval, acceptable erosion control must be completed.
- E. The performance wells criteria for mounds includes the following:
1. A minimum of seven performance wells shall be installed within and around the mound system. Well screen is required for the perforated sections of the performance wells. See Figure 11.6.
 - a. Two performance wells extending to the bottom of the gravel bed shall be installed within the distribution gravel bed in proportionate locations.
 - b. Two performance wells shall be installed at the down slope and toe of the mound at proportionate locations from centerline at a depth of 24 inches.
 - c. Two performance wells shall be installed at a depth of 24 inches, 25 feet down slope of the sand toe mound at proportionate locations from the centerline.
 - d. One performance well shall be installed at a depth of 24 inches, 10 feet upslope of the edge of the upslope sand bed at mound centerline for sloping sites and 25 feet upslope of for level terrain.
 - e. Performance wells shall be protected and encased within plastic, concrete or an approved equivalent to provide easy access.
 - f. All performance wells shall have concrete seals for the upper 12 inches

13.4 Shallow Trench Pressure Distribution (STPD) OWTS

- A. Pressure distribution systems are designed for sites that typically have shallow top soils over slowly permeable or fractured subsoils on slopes up to 30 percent.
- B. The site criteria for STPD OWTS includes the following:
 1. Percolation rate of 1 to 120 minutes per inch for STPD systems on slopes up to 30 percent.
 2. Rates faster than 1 minutes per inch are not acceptable.
 3. Percolation depth measured from native grade
 - a. 24 inches minimum on slopes up to 20 percent.

- b. 30 inches minimum on slopes from 20 to 25 percent.
- c. 36 inches minimum on slopes from 25 to 30 percent.
- d. 60 inches maximum on slopes up to 30 percent.

4. Systems shall have a minimum depth of 24 inches of suitable soil beneath proposed trench bottom as established by:

- a. Visual field observations and soil texturing to identify a limiting condition
- b. The rock content (as retained on the #10 sieve) shall not exceed 50 percent by volume within the first 24 inches of soil below trench bottom
- c. Soil hydro and bulk density tests (Zone 1 or Zone 2 soils)
- d. Plasticity Index tests as measured by ASTM D-4318-84 Atterburg Series, with results of less than 20 for Zone 3 or 4 soils
- e. Soil percolation testing with rates of 120 minutes per inch or better

5. Systems shall have a minimum depth of 24 inches below trench bottom to groundwater, fractured rock, consolidated rock, bed rock, or impermeable soils.

6. The addition of an approved pretreatment unit to a STPD does not mitigate 1 foot of the required minimum 24 inches of suitable soil beneath proposed trench bottom. 2 feet of acceptable native soil beneath the proposed trench bottom is required.

7. A minimum of 24 inches below trench bottom of permeable soil shall extend a horizontal distance of no less than 25 feet down gradient from the edge of the last proposed trench.

8. To maximize evapotranspiration, pressure distribution systems may not be installed below non-permeable type soils such as high shrink well clays, highly compacted soils, highly cemented soils, and/or massive or platy soil structures.

C. The design criteria for STPD OWTS includes the following:

1. The minimum trench spacing shall be 6 feet, center to center, on slopes less than 20 percent.

- a. Greater trench spacing is recommended on steeper slopes.

2. Distribution trenches shall follow the natural contour of the ground; trench bottoms shall be level.

- a. The maximum deviation along the downhill side of the trench shall not vary more than 0.25 feet (3 inches) vertically per a 100 foot run. Distribution trenches shall be angled or curved to meet this requirement. The distribution field should not be placed on concave land forms.

3. Approved distribution trench design. See Figure 13.4.

- a. Distribution piping shall be Schedule 40 PVC or greater of at least 3/4 inch diameter.
- b. Approved aggregate below the pipe

- i. Percolation rate of 5 to 120 minutes per inch 3/8 to 3/4 inch double washed gravel with less than 1 percent fines passing the 200 sieve.
- ii. Percolation rate faster than 5 minutes per inch - Pretreatment required before dispersal field.

c. 2 inches of aggregate is required over the perforated sections of the pressurized line.

d. Minimum requirement of backfill is 12 inches over the pipe.

e. Maximum trench depth shall be 60 inches.

Figure 13.4 – STPD Trench Detail

Note: The allowable width of STPD dispersal trench 18 to – 24 inches

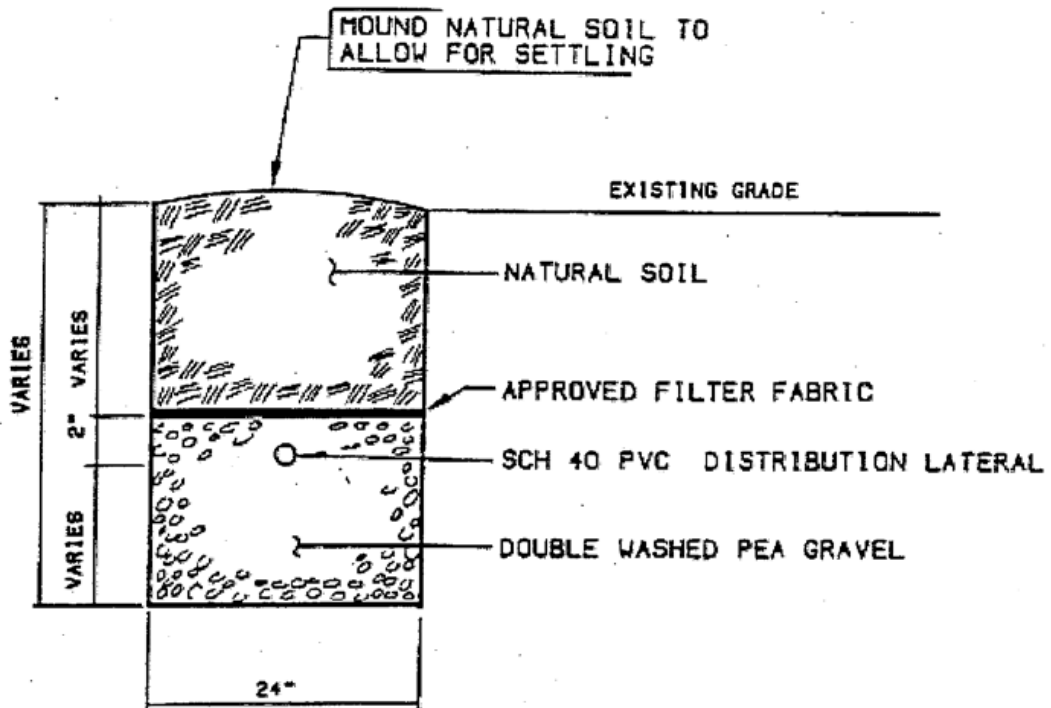

TRENCH DETAIL

NTS

4. Absorption Area. Shall be calculated as the sidewall beneath the distribution pipe. The bottom area of the trench is not included as absorption area for sizing purposes.
 - a. The maximum sidewall area allowed for any system design is 3 square feet per lineal foot of trench.
 - b. Center trench spacing shall be increased by 1 foot for every 6 inch increase in gravel depth.
5. Soil Cover. The quality of the back fill shall be consistent in structure and texture as the topsoil already existing on the site. A minimum depth of 12 inches is required.
 - a. Soil structure and texture above the trench is extremely important to maximize evapotranspiration.
 - b. Trenches shall not be installed below non-permeable types of soils (high shrink-swell clays, soils with massive structure, or highly compacted soils).
6. Designers shall calculate the total dynamic head loss of the entire distribution System, taking into account
 - a. Vertical differences.
 - b. Length of entire piping system.
 - c. Loss of all valves, tees, elbows, and appurtenances.
 - d. Head loss shall be referenced as feet of elevation
 - e. Hydraulic orifice discharge shall be a minimum of 60 inches for upward discharge. Orifices shall have a protective shield.
 - f. The recommended orifice spacing is 24 inches on center; however the maximum spacing is 36 inches. The first and last orifice shall be located 1/2 orifice space from the ends of the distribution lines.
7. Balancing Valves and Purge Valves. System shall have a balancing valve at the beginning of each perforated pressurized line and a purge valve at the end. See Figures 13.3f and g.
 - a. All valves shall be encased in plastic or concrete boxes. Metallic valves are prohibited.
 - i. All balancing valves shall be PVC Schedule 40 or higher gate valves.
 - ii. All purge valves shall be ball or gate PVC Schedule 40 or higher.
 - b. All boxes shall allow enough room for maintenance and adequate room to install stand pipes onto the end of the purge valves.
8. There shall be a minimum of 3 foot separation from the transmission line to the beginning of the aggregate portion of the trench or gravel bed.
9. The cross section of the transmission line and the beginning of the gravel portion of the trench shall be stepped so as to prevent seepage of effluent from trench to trench.
10. Maximum length of run for a perforated pressurized line shall be 75 lineal feet.

11. In the distribution network, orifices shall be placed in upward position using an orifice shield.
 12. The sump and pump installation shall be as specified in Sections 8.3 and 8.4
 13. Dosing siphons are prohibited in all pressure distribution type systems.
- D. The following construction criteria for STPD OWTS and specifications must be included with the system plans submitted with the permit application:
1. Placement of the pressurized transmission line from the sump tank to the first manifold must be a minimum of 24 inches below the surface of the ground.
 2. Construct trench beds with special attention to proper elevation and strict attention to contour.
 - a. Trenches shall not be installed when the soils are wet or excessively damp state.
 - b. Sidewall of trenches shall be scarified to remove all smears.
 - c. Place aggregate into the trench.
 - d. Install perforated piping, placing orifices upwards for the hydraulic test. Benching is strictly prohibited for the installation shallow trench pressure distribution systems regardless of the slope.
 3. Perform hydraulic test after the distribution system has been completed.
 - a. Pump must be adequate to deliver the required orifice discharge minimum of 60 inches for upward discharge to the lateral.
 - b. Distribution to all laterals shall be balanced.
 - c. This test shall be inspected by the designer/consultant and the Permit Authority REHS.
 4. Establish the finished grade of the STPD system by track rolling and grooming by hand. Complete required drainage work and erosion control measures before final inspection.
 5. Install performance wells and complete all details as shown on the plans.
 6. Prior to septic system final approval, acceptable erosion control must be completed.
- E. The performance wells criteria for STPD OWTS includes the following. A minimum of 6 performance wells shall be installed within and around the system to a depth of 24 inches below proposed trench bottom. See Figure 11.6.
1. 1 or more performance wells shall be installed between trenches in the middle of the leachfield.
 2. 1 or more performance wells shall be installed 10 feet down slope of the lowest trench line.
 3. 2 performance wells shall be installed 25 feet down slope of the lowest trench line.
 4. 1 or more performance well shall be installed at 10 feet upslope of the highest trench line.

5. Additional performance wells may be required for systems longer than 75 feet.
6. Permit Authority may require that performance well locations be changed in special situations.
7. Performance wells shall be properly installed to provide easy access.
8. Performance wells shall be a minimum of 24 inches below trench bottom.

13.5 At-Grade OWTS

- A. The Wisconsin At-Grade soil absorption system accepts septic tank effluent and treats and disperses it in an environmentally acceptable manner. At-grade systems are designed to allow for reduced soil permeability and/or depth to groundwater conditions below the bottom of the system. It serves the same function as in-ground soil absorption trenches and mound systems. The at-grade component contains pressure distribution laterals installed on top of a gravel distribution media, which is installed directly on top of a plowed native soil. The system is then covered with a loam or a similar soil. Figure 13.5a is for illustration purposes only. Note that the diagram for the Shallow In-Ground would require the addition of an approved pretreatment unit to meet the 3 feet of soil below trench bottom requirement.

Figure 13.5a
SIG (requires pretreatment), At-Grade, Mound Soil Below Trench Bottom Requirements

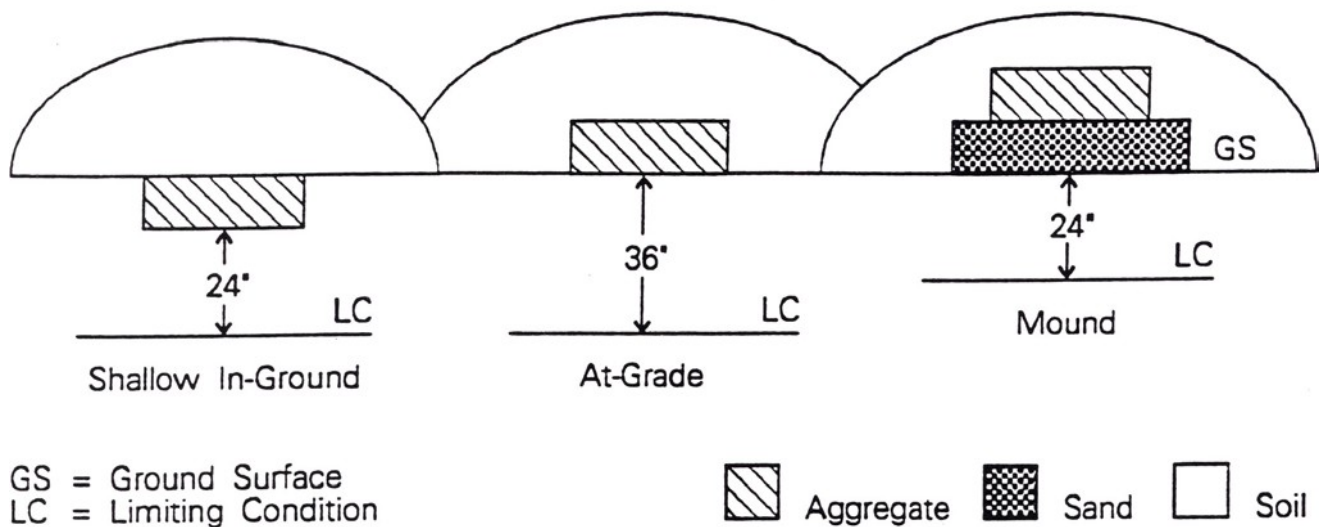

- B. The minimum site criteria for At-grade OWTS. Permeable soil is required to a depth of 36 inches. Percolation testing done at 24 or 36 inches must meet the following criteria:
1. Percolation testing may also be required at 12 inches if this is the worst soil horizon encountered.
 2. 1 to 120 minutes per inch for at-grade systems on slopes up to 25 percent. Note: A sand filter or other approved pretreatment unit is required when percolation rates are faster than 5 minutes per inch or slower than 90 minutes per inch.
 - a. Rates faster than 1 minute per inch are not acceptable.
 3. Separation from native grade to elevated groundwater is 36 inches, but may be reduced to 24 inches with the use of a sand filter or other acceptable pretreatment unit.
 4. Minimum separation is 36 inches from fractured rock, rock exceeding 50 percent by volume, or bedrock as measured from native grade.

5. Placement of the at-grade system in areas that require the removal of large trees, boulders, or rock outcroppings is not permitted.
- C. The following design criteria shall be used for at-grades in addition to the most current edition of the *Wisconsin At-Grade Component Using Pressure Distribution Manual for Private On-Site Wastewater Treatment Systems*.
1. Linear Loading Rate (LLR)
 - a. Designers shall estimate the LLR for all proposed At-Grade systems and shall design the width dimensions and gravel dimensions accordingly, so that the distribution bed is long and narrow and on contour (Refer to Figure 13.5b).
 - b. When the depth to a limiting condition (for example impermeable soil layer or rock is only 36 inches (or 24 inches with pretreatment) the LLR shall not exceed 4 gallons per linear foot per day (refer to Table 13.5a and Figure 13.5d).
 - c. If it can be demonstrated that the wastewater flow will be vertical as well as horizontal, a higher LLR may be proposed.

Figure 13.5b – At-Grade

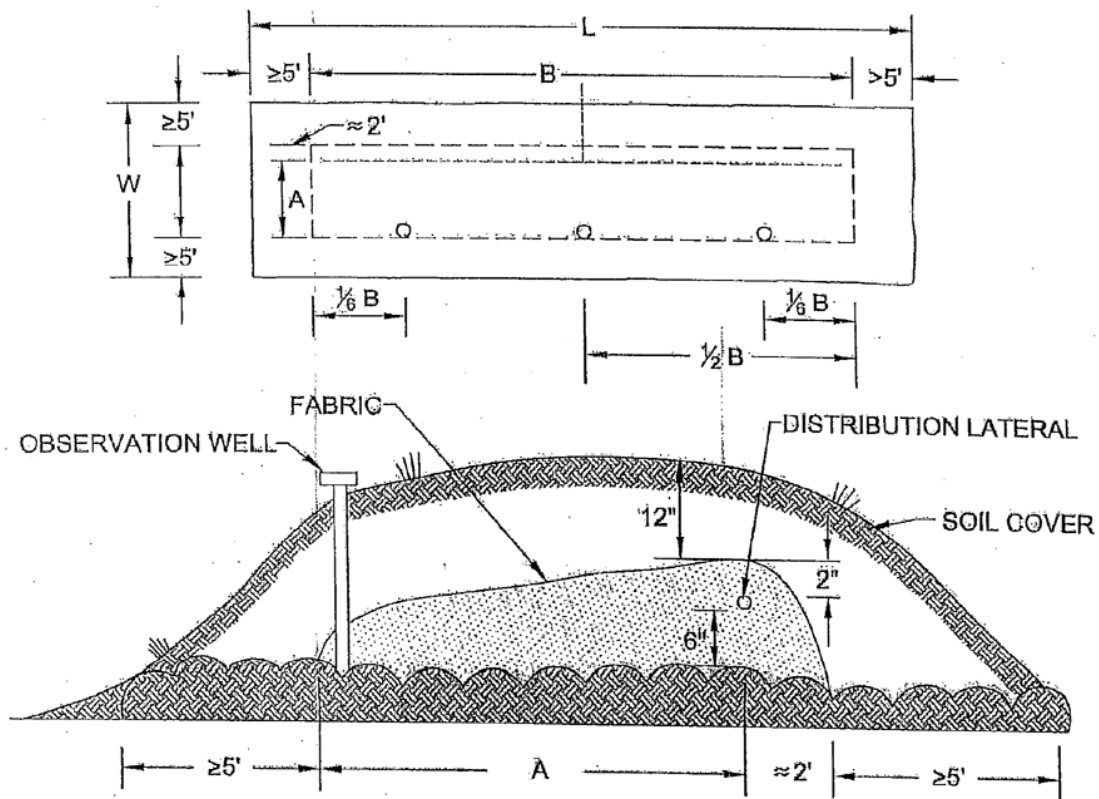

PLAN VIEW AND CROSS SECTION OF WISCONSIN AT-GRADE UNIT WITH A SINGLE ABSORPTION AREA ON A SLOPING SITE

2. Soil Loading Rate

- a. The soil loading rate is to be based on the most restrictive soil horizon in contact with the distribution area. Use the percolation rate of the most restrictive soil horizon(s) and apply the corresponding Sewage Application Rate (SAR) from Table 7.2a.

3. Configuration (Refer to Figure 13.5b)

- a. The length of the gravel bed (B) shall be greater than or equal to the design wastewater flow plus the LLR.
- b. The basal area shall be greater than or equal to the design wastewater flow divided by the SAR.
- c. The effective width of the gravel bed (A) shall be greater than or equal to the design wastewater flow plus basal area length (B). In no instance shall the width of the distribution bed below and downslope of the lateral exceed 15 feet.
- d. Absorption bed depth
 - i. There shall be a minimum of 6 inches of gravel below the distribution pile for residential systems with 2 inches of gravel cover over the pipe.
 - ii. There shall be a minimum of 9 inches of gravel below the distribution pile for commercial systems with 3 inches of gravel cover over the pipe.
- e. Only single distribution beds are acceptable. Dual beds are not allowed.
- f. The gravel bed shall extend at least 2 feet above the uppermost distribution pipe lateral.

4. Aggregate

- a. 3/8 inch double washed pea gravel size to 2 inch double washed drain rock
- b. The percentage of fines of washed gravel shall not exceed 1 percent by weight.

5. Natural Contour

- a. The distribution bed shall explicitly follow the natural contour of the ground. The bed must be installed within a tolerance of 0.25 feet (3 inches) vertically per 100 feet horizontally.
- b. Distribution beds shall be angled or curved to meet this requirement.
- c. The distribution bed shall not be placed in a concave landscape position. See Figure 13.5b.

6. Soil Cover

- a. A geo-textile synthetic fabric (Mirafi 140 N or equivalent) is to be placed over the aggregate bed.
- b. 12 inches of soil covering after settling is to be placed over all aggregate. Additional depth of topsoil must be placed during the time of construction to assure that the minimum depth is achieved following natural settling of the soil.
- c. Soil cover shall extend a minimum of 5 feet uphill and on both sides of the gravel bed. Downslope soil cover shall conform to Table 13.3d.

7. Distribution System

- a. Total Dynamic Head Loss. Designers shall calculate the total dynamic head loss of the entire distribution system.
 - i. Vertical differences
 - ii. Length of entire piping system
 - iii. Loss of all valves, tees, elbows and appurtenances
 - iv. Head loss shall be referenced in feet of elevation
 - v. Distribution piping shall be Schedule 40 PVC or greater of at least 3/4 inch diameter
 - vi. Hydraulic orifice discharge shall be a minimum of 60 inches for upward discharge. Orifices shall have a protective shield.
 - vii. Orifice spacing shall be a maximum of 36 inches on center (Closer spacing is preferred)/
 - viii. Size of orifices shall be 1/8 to 3/16 of an inch
 - b. Balancing Valves and Purge Valves. System distribution manifolds shall have a balancing valve at the beginning of each pressurized line and a purge valve at the end.
 - i. All valves shall be protected and encased within plastic, concrete or other approved type box to provide easy access and maintenance. Metallic valves are prohibited.
 - ii. Box size shall be 10 inches across or larger, round or square, and must allow room for maintenance and/or to install stand pipes onto the ends of the purge valves.
 - iii. Balancing and purge valves shall be PVC Schedule 40 or higher gate or ball type valves.
 - c. Perforated Pressurized Lines.
 - i. 1 or 2 pressurized lines may be used in the At-Grade bed with the goal being to provide maximum distribution of wastewater along the length of the At-Grade. Where 2 lines are used, the distance between the lines shall be 24 inches.
 - ii. The maximum length of pressurized lines shall be 75 feet.
 - iii. The maximum distance between perforations shall be 36 inches. Where 2 pressurized lines are used the holes shall be staggered between the 2 lines.
 - iv. Hydraulic orifice discharge shall be a minimum of 60 inches for upward discharge. Orifices shall have a protective shield
8. Sump and Pump. Refer to Sections 8.3 and 8.4 for required sump and pump features. Note Automatic dosing siphons are NOT allowed in at-grade sewage dispersal systems.
9. Sizing formulas for at-grade systems. Sizing calculations for all at-grade dimensions shall be provided with all proposals.

- D. The construction criteria for at-grade OWTS includes the following
1. The use of wheel type vehicles is prohibited.
 - a. For the purpose of ripping
 - b. When driving on any areas that have been ripped.
 - c. When placing or moving the soil cover.
 - d. At any time that the soil conditions are wet, moist, or saturated.
 2. Placement of the pressurized transmission line from the sump tank to the at-grade manifold shall be a minimum of 24 inches below the surface of the ground.
 3. Site preparation of soil surface to a depth of 8 to 12 inches.
 - a. Mow excessive vegetation:
 - i. Remove trees
 - ii. Cut and grind stumps to a depth of 12 inches.
 - iii. Perform initial ripping parallel to the contours of the ground and only within the limits of the gravel base; rippers set 8 to 10 inches apart. The interface of the native soil and the at-grade soil shall be ripped after the gravel has been placed and just prior to placement of the at-grade soil cover.
 - iv. Prohibit all traffic on any ripped surfaces until the full depth of gravel bed or cover material has been placed.
 4. Gravel Bed:
 - a. Temporary form boards are required to hold aggregate in place to construct the gravel bed.
 - b. The temporary form boards shall be removed prior to placement of the soil cover.
 - c. Place performance wells as specified in Section 13.4E
 - d. Place aggregate in the designated tilled area to the appropriate depth as specified in D.2 above.
 - e. Work from the upslope side and avoid compaction along the downslope side.
 5. Construct distribution network prior to cover placement.
 6. Perform hydraulic test after the distribution has been completed.
 - a. Pump must be adequate to provide hydraulic orifice discharge of a minimum of 60 inches upward discharge. Orifices shall have a protective shield.
 - b. Distribution to all laterals shall be equal.
 - c. This test shall be inspected by the consultant and the Permit Authority.
 7. Place soil cover:
 - a. Place 2 inches (residential) or 3 inches (commercial) aggregate over the distribution network.
 - b. Place geo-textile fabric over the aggregate. Extend only to the edge of the aggregate.
 - c. Condition soil cover with sufficient moisture to allow track rolling to a firm cohesive

- surface.
 - d. Rip area to be covered with cover soil.
 - e. Place soil against the form boards by track rolling only. Remove the form boards.
 - f. Place soil over entire gravel bed by track rolling and grooming by hand. Complete proper drainage work and erosion control measures before final inspection. Seed and mulch.
8. Establish the final grade of the at-grade by track rolling and grooming by hand.
9. Install performance wells and details as shown on the plans.
- E. The performance well criteria for at-grade OWTS include the following:
- 1. A minimum of 5 performance wells shall be installed within and around the system.
 - a. 1 performance well shall be installed 10 feet upslope of the upslope gravel bed at the system centerline for sloping sites. The well depth shall be 36 inches below original grade. If the system was designed for 24 inches of soil and utilizing a pretreatment unit, the well depths shall be 24 inches below original grade.
 - b. 2 performance wells shall be installed 25 feet down slope of the gravel toe at-grade at proportionate locations from the centerline. The well depths shall be 36 inches below original grade. If the system was designed for 24 inches of soil and utilizing a pretreatment unit, the well depths shall be 24 inches below original grade.
 - c. If the hydraulic gradient cannot be determined on flat sites, 2 performance wells will be required on each side of the system installed 25 feet from the gravel toe at proportionate locations from centerline. The well depths shall be 36 inches below original grade or 24 inches below original grade if a pretreatment unit was utilized.
 - d. 2 performance wells shall be installed at the down slope toe of the gravel bed at proportionate locations from centerline at a depth of 24 inches. The depth of these performance wells shall extend to the gravel soil interface. The slotted/screen casing of the well shall extend through the entire depth of the gravel and the gravel (instead of sand) shall be placed in the annulus between the casing and the borehole. For long systems, at least 1 performance well shall be installed in each 75 feet of lateral. See Figure 11.6.

13.6 Shallow In Ground (SIG) OWTS

- A. Shallow In-Ground Systems (SIG) utilize shallow depth trenches and pressure distribution methods of disbursement of effluent.
- 1. SIG systems are designed with the acceptable fill material as soil cover.
 - 2. The fill or soil cover is placed in a manner similar to the Permit Authority requirements for Filled Land systems.
 - 3. SIG systems are designed for sites that typically have shallow top-soils over slowly permeable or fractured subsoils on slopes up to 25 percent.
- B. The site criteria for SIG OWTS includes the following:
- 1. Percolation rate of 1 to 120 minutes per inch for systems on slopes up to 25 percent.

2. Percolation rates faster than 1 minute per inch are unacceptable.
 3. Percolation tests shall be at trench depth and at 2 and 3 feet below the trench depth, if necessary after soil profile review.
 4. Visual field observations and soil texturing to identify any limiting conditions.
 - a. Systems shall have a minimum depth of 36 inches of suitable soil beneath trench bottom and 36 inches from trench bottom to groundwater. These may be reduced to 24 inches if an approved pretreatment is used.
 - b. The rock content (as retained in the #10 Sieve) shall not exceed 50 percent by volume within the first 24 inches of soil below trench bottom.
 - c. Soils hydrometer and bulk density tests (Zone 1 or Zone 2 soils).
 - d. Plasticity Index test results less than 20 for Zone 3 or 4 soils (ASTM D-4318-84 Atterburg Series).
 5. System sizing shall be based upon soil morphology and average percolation rate, if that results in larger system. Refer to Sonoma County Percolation Test and Sizing Chart for non-standard systems recommended sizing.
 6. Systems shall have a minimum separation of 36 inches to groundwater, fractured or impermeable soils beneath trench bottom and 48 inches to bedrock as measured beneath proposed trench bottom. Note that minimum separation may be reduced to 24 inches below trench bottom if acceptable pretreatment is used.
 7. To maximize evapotranspiration pressure distribution systems as the SIG may not be installed below non-permeable soils such as high shrink-swell clays, highly compacted soils, and/or soils with massive or platy structures.
 8. See Sections 12.1 and 12.2 and Table 7.2c for restrictions on use and other required setbacks.
 9. Soil cover of 12 inches minimum is required.
- C. The design criteria for SIG OWTS includes the following:
1. See Section 13.3C.
 - a. Refer also to the following standards.
 - i. Permit Authority regulations for Filled Land Systems.
 - ii. Permit Authority Mound Construction Regulations.
 2. Trench Spacing:
 - a. Minimum of 8 feet on center for 0 to 12 ½ percent slope.
 - b. Minimum of 10 feet on center for 12 ½ to 20 percent slope.
 3. Sand filter or other approved Pre-treatment units are required on sites with percolation rates faster than 5 or slower than 90 minutes per inch.

4. A dual system with an approved diversion valve shall be designed and installed for SIG systems.

D. The construction criteria for SIG OWTS includes the following:

1. See Section 13.3D.

E. The performance well criteria for SIG OWTS includes the following:

1. See Section 13.3E.

13.7 Subsurface Drip Dispersal OWTS

A. A subsurface drip dispersal OWTS is a pressurized wastewater distribution system that delivers small, precise doses of effluent to shallow subsurface dispersal/reuse fields. The distribution piping is small diameter flexible polyethylene tubing (dripline) with small in-line emitters that discharge effluent at slow controlled rates. A typical subsurface drip dispersal system installation includes a septic tank, supplemental treatment, a dosing chamber, pump(s), control panel, timed dosing and supply and return flow monitoring, particulate filter, filter backwashing and drip line flushing, driplines, and monitoring wells. A supplemental treatment system that reduces effluent strength to the Section 13.9 Pretreatment Units quality standards is required.

B. The site criteria for subsurface drip dispersal OWTS includes the following:

1. Depth to a limiting condition and permeable soils (1 to 120 minutes per inch) below the drip line bottom shall be a minimum of 24 inches.
2. The soil above the drip line proposed depth shall be permeable (1 to 120 minutes per inch). This excludes massive or platy structured soils. Soils subject to flooding, excessive irrigation, farming practices, grading, ripping or roto-tilling are also not acceptable. The quality of acceptable soils above the dripline shall be equal to those below the dripline.
3. A minimum of 24 inches of permeable soil below emitter depth shall extend a horizontal distance of no less than 25 feet down gradient from the edge of the last proposed drip line, including expansion areas.
4. Subsurface drip irrigation system sites shall not exceed 30 percent slope without an approved variance and a geotechnical study required for slope stability and suitability.
5. Subsurface drip irrigation system sites shall not exceed 20 percent slope when fill is placed over the drip system without an approved variance and a geotechnical study required for slope stability and suitability.

C. The design criteria for subsurface drip dispersal OWTS includes the following:

1. Separation between emitter line laterals shall be a minimum of 2 feet.
2. Dripline installations generally have emitters spaced 24 inches apart maximum and 12 inches minimum.

3. A standard drip system is typically installed 12 inches into native soil. A minimum native soil depth of 6 inches may be allowed with disinfection. The maximum soil cover allowed is 18 inches. (See Figure 13.8a).

Figure 13.7a – Drip Trench Cross-Section

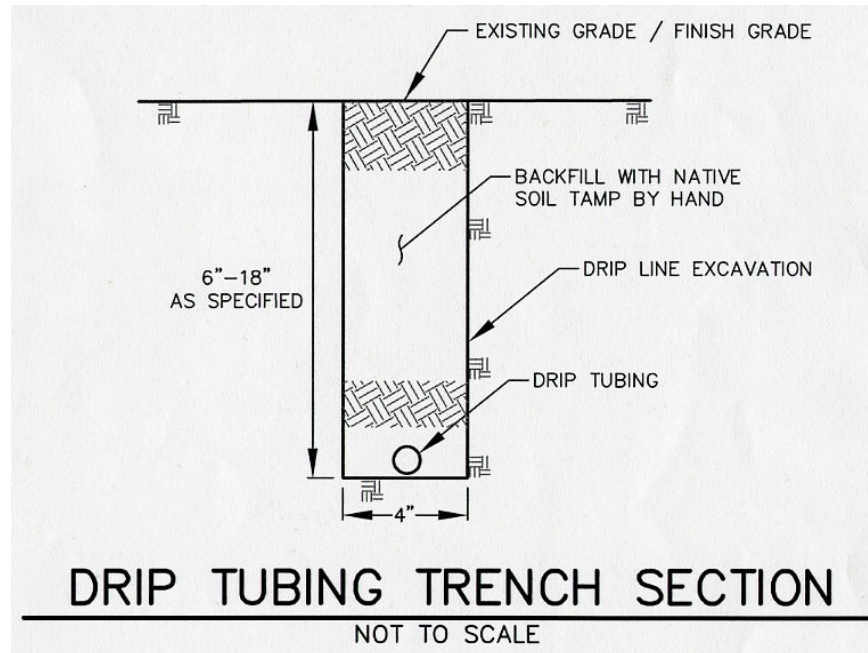

4. Soil application rates generally assume each emitter will wet an area of 4 square feet. However, this assumption is not valid in all soil types because the size of the wetted volume depends on soil characteristics and dosing cycles. Sizing of the subsurface drip dispersal system shall be based on both soil morphology and the percolation rate at the most restrictive horizon (See Table 7.2a for percolation rates). Designers shall clearly demonstrate the minimal square footage required as determined by the soil morphology and percolation rate. Percolation tests may be waived for developed parcels in some circumstances.
5. The designer shall also determine the number of zones, the number of doses, the quantity of the dose, the head losses, spacing of drip lines, spacing of drip emitters, diameter of the drip tubing (typically 0.55 inches), pump size, location of air relief valves and the “frequency of flushes.”
6. Distribution zones shall be designed to be consistent with dripline manufacturer requirements. The length of each distribution line shall not exceed manufacturer’s specifications to insure equal distribution to each emitter. If multiple zones are designed, dosing must be automatically alternated between each zone.
7. All subsurface drip dispersal systems require an approved supplemental treatment unit for treating septic effluent and mechanical filtration with Vortex/Spin Filters or Disk Filters. The level of supplemental treatment must comply with NSF Standard 40 or to the satisfaction of the Permit Authority, Section 13.9 or as specified by the manufacturer,

whichever results in most improved effluent quality. Different subsurface drip dispersal products may require different levels of supplemental treatment.

8. Drip systems are “closed loop” networks with control valves and supply/return manifolds to allow for periodic line flushing (See Figure 13.8b). Required flushing velocity shall be a minimum of 1 foot per second.

Figure 13.7b – Single Zone Schematic

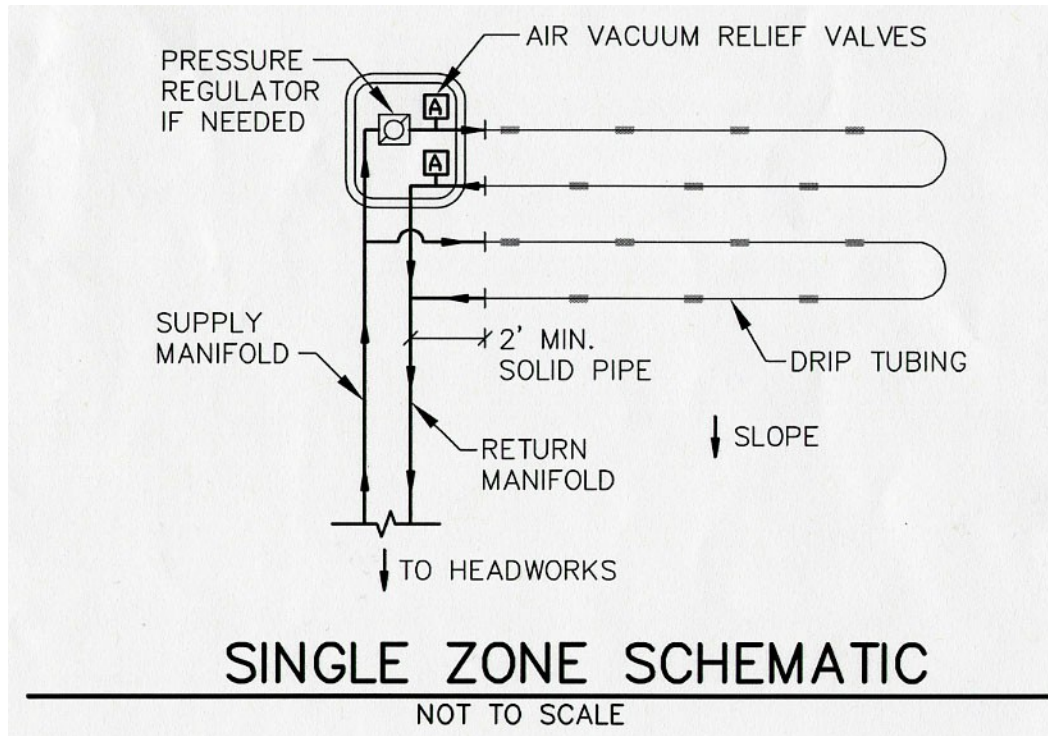

9. Designer shall employ measures to prevent uneven distribution of the dispersal field due to drain down following a pump cycle. Per California Plumbing Code (CPC), spring check valves are not allowed for wastewater applications. (See Figure 13.8c for example of a top feed manifold).
10. Provide 2 feet of solid tubing/pipe between the manifold and the drip tubing (See Figure 13.8d).

Figure 13.7c – Top Feed Manifold

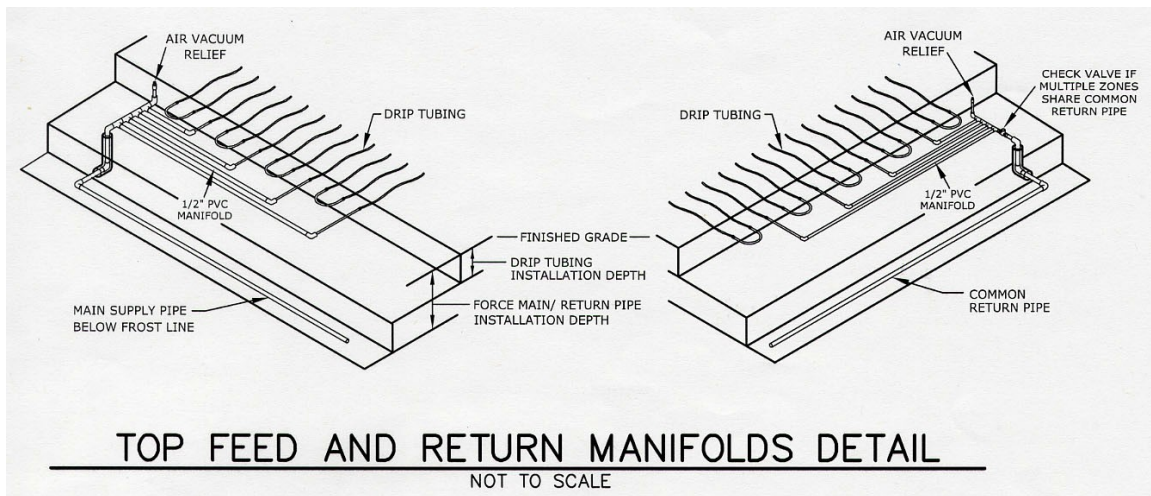
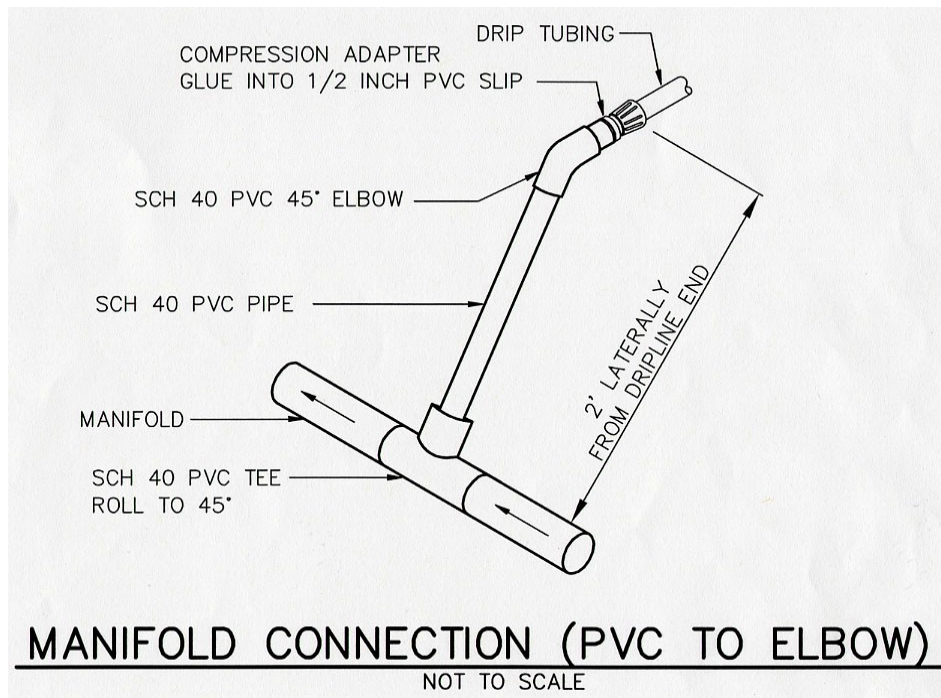
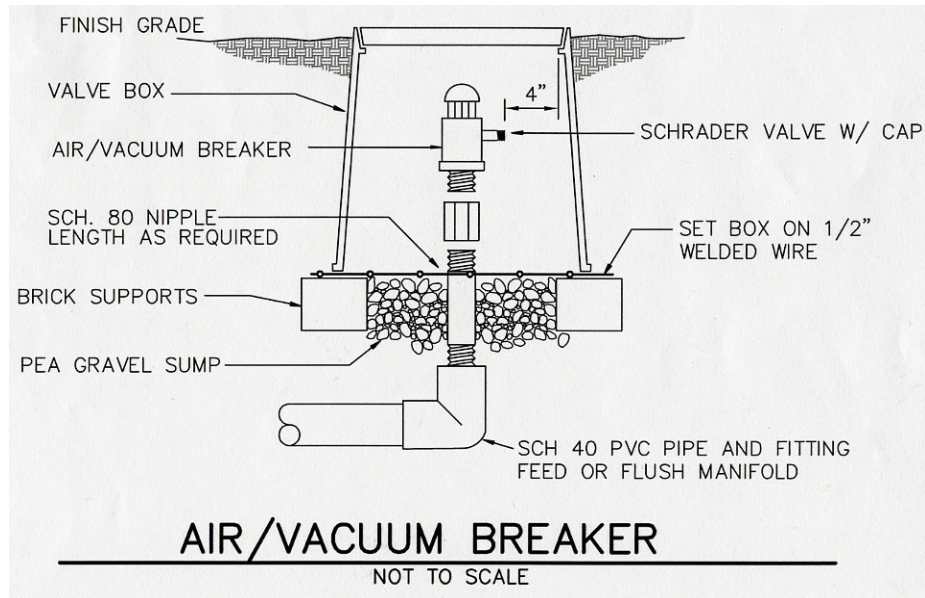

Figure 13.7d Manifold Connection



11. Air/vacuum release helps prevent soil particles from being sucked into emitters and is required on all drip systems. Air/vacuum release valves must be installed at the high point of each distribution sector of the supply and return manifold. The air relief valves shall be equipped with Schrader valves in order to check pressure. These valves must be located in valve boxes with adequate room to attach a pressure gauge (See Figure 13.8e).

Figure 13.7e – Air Relief with Schrader Valve



12. All system components (filters, control valves, air-vacuum relief valves, pressure regulators and controllers) shall be appropriately sized for the system dosing and flushing flow rates, and shall meet specifications of the drip line manufacturer (See Figure 13.8f for example of headworks). All transport piping, supply and return manifolds and fittings must be Schedule 40 PVC or Schedule 80 PVC if threaded fittings are utilized. All filters must be sized to operate at a flow rate greater than or equal to the maximum design discharge rate of the system including the field flush cycle.

Figure 13.7f – Headworks

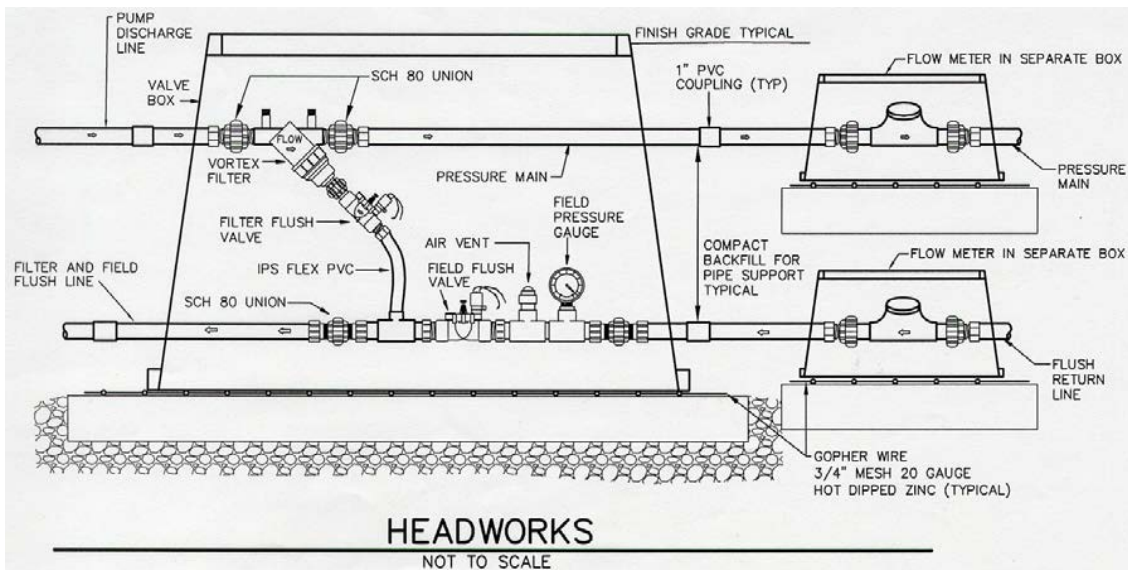

13. Filter backwash and line flushing debris must be returned to the septic tank or into the sump chamber.
14. Totalizing flow meters (in gallons) are required on the supply and return distribution lines. Flow meters must be installed in a readily accessible location for reading and servicing.
15. A controller capable of timed dosing and automatic line/filter flushing is required.
16. Disinfection of the treated wastewater shall be incorporated in cases of well-drained soils (less than 1 minute per inch or faster) or where drip dispersal systems only have a minimum of 6 inches of native soil cover above the drip line (see Figure 13.8g). If 6 inches of approved fill is added above the 6 inches of native soil cover, disinfection will not be required.
17. For aerobic treatment unit (ATU) systems that function with external blowers, a cutoff switch or interlock that disables the pump must be built into the control panel so the blower may not be disconnected.

Figure 13.7g – Disinfection Unit

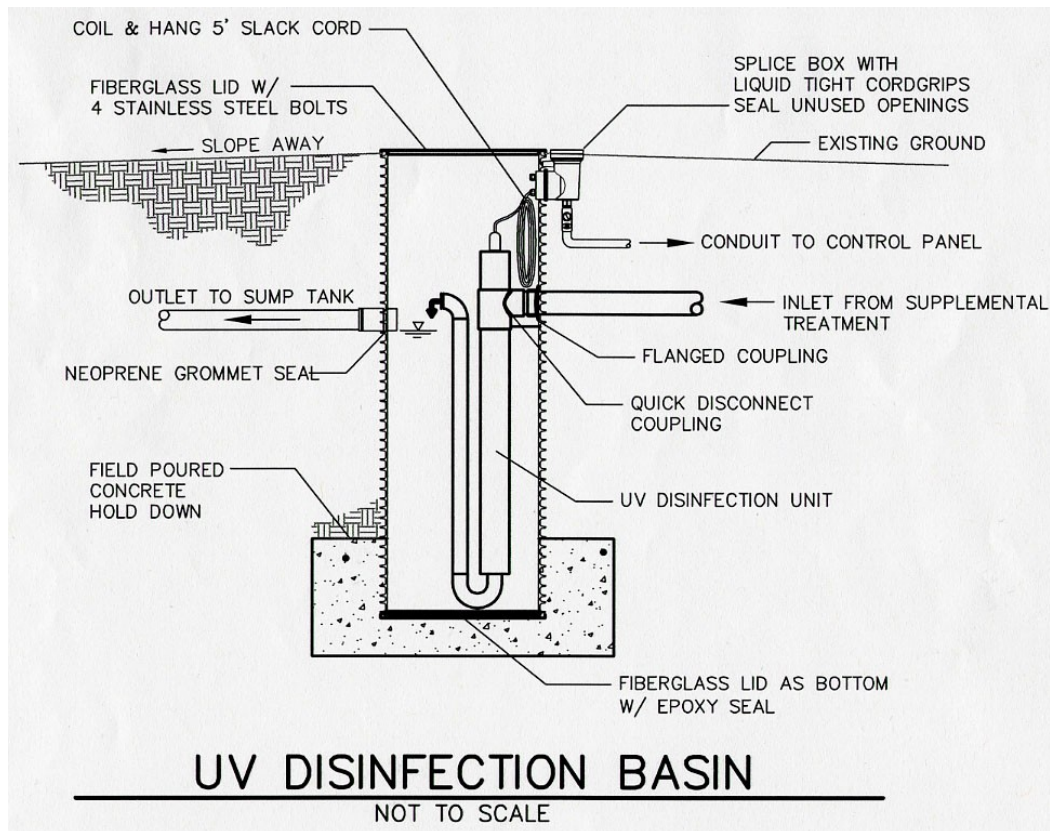

D. The construction criteria for subsurface drip dispersal OWTS includes the following:

1. Dripline can be trenched (by hand or with a trenching machine) into narrow, shallow trenches or plowed directly into the soil (with a vibratory plow or other insertion tool) and backfilled without gravel or geotextile.
2. To the extent possible, systems should be designed for the dripline lateral to follow the contour. However, whenever drip lines cannot follow the contour, distribution network driplines with Pressure Compensating (PC) emitters shall be installed in grid patterns to accommodate irregularly shaped sites or landscape irrigation applications.
3. Valves must be readily accessible for service and/or inspection. All valve boxes must be protected from gopher soil movement. A detail of the valve box must be included on the plans. Specify concrete, hardware wire or similar bottom.
4. A ground cover (turf, fruit trees or other appropriate landscaping) must be planted over the drip field after installation to provide additional treatment, prevent erosion and increase wastewater reuse through plant evapotranspiration.
5. Fill material may only be placed above native soil for soil cover, and shall not be used to meet required soil depth minimums. The system designer shall describe the type of fill to be placed in terms of texture and structure, the depth and method of ripping before placement. No part of the subsurface drip dispersal field may be located where the site slope exceeds 20 percent when fill is used.
6. Owners should avoid activities that might damage the drip tubing or compact the soil.
7. After the final electrical inspection of the associated building/electrical permit is approved by the Building Inspector, a startup inspection must be scheduled with the system designer, installer, service provider and the Permit Authority Well and Septic Section staff.

E. The performance well criteria for subsurface drip dispersal OWTS includes the following:

1. A minimum of 4 performance wells shall be installed around the drip dispersal field.
 - a. 1 performance well shall be located 10 feet upslope of the system to a minimum depth of 24 inches below the drip line depths.
 - b. 1 or more performance wells shall be located 10 feet down slope of the system to a minimum depth of 24 inches below the drip line depths.
 - c. 2 performance wells shall be located 25 feet down slope of the system to a minimum depth of 24 inches below the drip line depths. See Figure 11.6.

13.8 Pretreatment Units

- A. Pretreatment units may be used in conjunction with standard or non-standard systems where the site and soil conditions are not adequate. Standard systems with a pretreatment unit are considered non-standard system.

- B. In cases where a pretreatment system is used, Permit Authority and the RWQCB may allow a reduction in the minimum depth of soil below trench bottom to 2 feet. However, in all instances, at least 2 of the required 3 feet of soil beneath trench bottom must be acceptable native soil.

- C. Recirculating sand filters are also an approved pretreatment units. Sand filtration may be defined as the intermittent application of wastewater to a bed of granular material that has an under drain to collect and discharge the final effluent. The purpose of sand filters is to pretreat the effluent and improve wastewater quality.
 - 1. The design of sand filters in Sonoma County is based on the “Guidelines for the Use of Sand Filters” (Technical Review Committee, August 2, 1989. Washington State Department of Health, Olympia, Washington). Under the Permit Authority waiver standards, designers may propose to the Permit Authority Liquid Waste Specialist, the use of sand filters to justify increasing soil application rate.

- D. Appendix A contains a list of approved pretreatment systems. Appendix A will be updated annually.